

RADIO-CRAFT

HUGO GERNSBACK, *Editor*

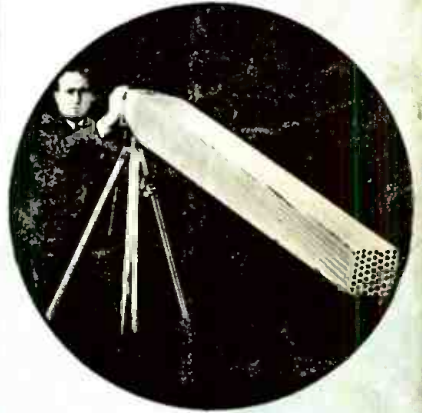

F.M. ORGAN



LONG-SHOT MIKE

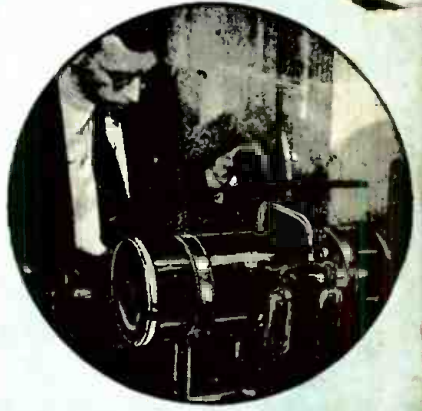

"BREADBOARD" TUBE



SOUND ANALYZER



**ROBOT
AIR-RAID "ALERT"
RADIO SET**
See Page 204

OCT 25c CANADA 50c 1941 RADIO'S GREATEST MAGAZINE PUTTING "OOMPH" INTO RADIO SETS • DIRECT-READING V.-T. METER HOME-BUILT P.A. & RECORDING UNIT • POLICING THE KILOCYCLES

It's easy to own a Hallicrafter

on the Radio Shack Payment Plan

Immediate Delivery
on all Models
Easy Terms

"MORE THAN EVER BEFORE"

We urge you not to wait until it becomes impossible to buy a communication receiver at any price. Through long range planning and tremendous buying, we are in a position to fill your order immediately on the receiver of your choice out of our stock—No Waiting.

THE HALLICRAFTER SX28

- 1 One of the finest communication receivers available is the Hallicrafter SX28. Its design has set new standards in performance. You will find it a reliable and consistent performer giving you not only complete coverage from 10 meters through all the amateur bands but coverage on the broadcast band for the family to enjoy.

"A \$5.00 deposit will hold Model SX28"

THE SKY CHAMPION S-20R

- 2 The Sky Champion! A favorite with the short wave DX fan and amateur operator. It offers professional styling, operating flexibility, and electrical performance that is truly outstanding. Electrical band spread and noise limiter are included amongst the features of this splendid radio set. The Sky Champion represents a value that is very hard to beat.

"A \$5.00 deposit will hold a Sky Champion for you"

MODEL SX-24 SKY WRITER DEFIANT

- 3 We know that there is no more popular receiver than the model SX-24 Sky Writer Defiant. Its performance can be compared favorably with most receivers selling at twice the price. Every advanced feature of the Hallicrafter's line is incorporated in the model SX-24. Complete coverage is provided from the 10 meter amateur band through the broadcast band. Automatic noise limiter, separate calibrated band spread dial, crystal filter, and push pull Audio out-put stage represents a few of the features to be found in this outstanding radio receiver.

THE SKY BUDDY

- 4 The new Sky Buddy is an amateur in every respect covering everything on the air from 44 MC to 545 KC including the 10 meter band. It employs many of the features found in the higher priced Hallicrafter receivers.

Send today for our new catalog on everything for the Experimenter and Amateur

THE RADIO SHACK

167 Washington St., Boston, Mass., U.S.A.

Please send me details of your easy payment plan. I am interested in Hallicrafters Model
Enclosed please find deposit.

NAME

ADDRESS

Send catalog

1



2



3



4



The RADIO SHACK

167 WASHINGTON ST., BOSTON, MASS., U.S.A.

Certainly -- I Give You Both TRAINING AND EXPERIENCE when I Train You at Home to BE A RADIO TECHNICIAN



LEARN RADIO THOROUGHLY

from My Easy-to-Understand Lesson Texts



Radio Technicians earn good pay, get and hold good jobs, because they KNOW Radio — know the operation of various Radio circuits—know where to look for trouble when it occurs

—know how to adjust circuits to perform most efficiently. That's why the background of every capable Radio Technician is a thorough knowledge of Radio theory and practice. My 67 Lesson Texts give you this knowledge in practical, easy-to-understand explanations, accompanied by hundreds of illustrations, diagrams, examples. You learn quickly because my Lessons are prepared especially for study at home—with more than 27 years of experience in home instruction behind them.

GET ACTUAL EXPERIENCE

And Earn \$5 to \$10 a Week Extra in Spare Time While Learning

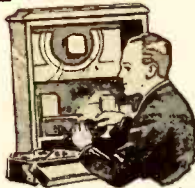

I show you how to get and handle Radio service work—how to make \$5, \$10 a week fixing sets in your neighborhood in spare time a few months after enrolling. This time gives you practical experience with actual Radios, gives you confidence, helps prepare you for a good full time Radio job. I send you special "Extra Money Job Sheets" showing you how to do more than 50 Spare Time Radio Jobs. You get these as you progress with my Course and Experiments and gain the knowledge and skill to do actual work. Many men have paid for their Course with spare time money earned this way.

YOU GET THIS PROFESSIONAL SET TESTER

To Help You Make Extra Money, Equip Yourself for Work After Graduation

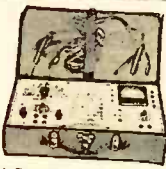

You get this Professional Set Serricing Instrument to help you make more money and do faster, more professional work. It is included as part of your regular outfit: 1. All wave Signal Generator (6 ranges, from 130 to 28,000 kilocycles), 2. Audio Oscillator (about 400 c.p.s.), 3. Output Indicator (5 ranges), 4. D.C. Voltmeter (5,000 ohms per volt, 5 ranges up to 1,500 volts), 5. A.C. Voltmeter (1,000 ohms per volt, 5 ranges; 1.5, 15 and 150 milliamperes and 15 amperes), 6. Ohmmeter (14 ranges, fraction of an ohm to 50 megohms). This instrument is built to professional standards. You also get a complete set of accessories for making practically any Radio measurement necessary in servicing home, auto Radios and commercial equipment.

BUILD RADIO EQUIPMENT

With Standard Radio Parts and Tubes I Send You



You get, as part of my Course, more than 100 standard Radio parts, including tubes, condensers, resistors, punched chassis bases, hardware, soldering iron, solder, wire, with which you assemble many Radio receiver, Radio transmitter and other Radio circuits, including Frequency Modulation circuits. You will actually test it with a tester which you assemble. This tester is useful in spare time Radio repair and service work while learning. You get practical experience assembling and testing these circuits—learn how to identify, install standard Radio parts, to test, align Radio circuits you will encounter on actual work as a Radio Technician. This actual work with Radio parts makes the study of my Course fascinating, and practical.

PROVE YOUR KNOWLEDGE

By Tests and Experiments on Equipment You Build



My Special Lesson Texts supplied with my 6 Experimental Kits of Radio Parts show you how to test the performance of the circuits you build and how to use the test equipment in measuring voltage, current, resistance, amplification—how to test and align the circuits for most efficient operation—how to detect troubles in circuits and how to correct them. You learn these facts quickly by actually working with real Radio equipment instead of simply reading books. You get need to make extra money in spare time while learning—and to fix commercial Radio equipment when you become a Radio technician. Mail the Coupon NOW.

Why Many Radio Technicians I Train Make \$30, \$40, \$50 a Week

It takes both Training and Experience to qualify you as a skilled Radio Technician. You get BOTH with my Course. Radio Technicians I have trained hold good jobs in practically every branch of Radio, selling, servicing, installing, repairing home and auto Radio sets. N.R.I. Trained Radio Operators have good jobs in Broadcasting, Commercial, Aviation, Police, Ship Radio Stations. Many N.R.I. — Trained Technicians operate their own part or full time Radio businesses, fixing, selling Radio Sets. Others make good money in Public Address work and other branches of Radio. I train you to be ready when Television opens opportunities. Mail the Coupon—get complete details of how I train you at home in spare time.

Beginners Quickly Learn to Earn \$5 to \$10 a Week Extra in Spare Time

Nearly every neighborhood offers opportunities for a good part time Radio Technician to make extra money fixing Radio Sets. I train you to take advantage of these opportunities—to make extra money starting a few months after you enroll—to gain valuable experience in practical Radio work.

MAIL THE COUPON—get my Sample Lesson and 64-page Book "Rich Rewards in Radio" at home. They're Free. See what Radio offers you as a skilled Radio Technician or Operator. Learn how practical my Course really is. Read letters from more than 100 men I have trained telling what they are doing, earning. Mail the Coupon NOW—in an envelope or paste it on a penny postal.



EXTRA PAY IN ARMY, NAVY

Every man likely to go into military service, every soldier, sailor, marine, should mail the Coupon Now! Learning Radio helps men get extra rank, extra prestige, more interesting duty at pay up to 6 times a private's base pay. Also prepares for good Radio jobs after service ends. IT'S SMART TO TRAIN FOR RADIO NOW!

FREE LESSON

I want to prove our Course gives practical, money-making information; that it is easy to understand—what you need to master Radio. My Lesson Text, "Radio Receiver Troubles—Their Cause and Remedy" covers a long list of Radio receiver troubles in A.C., D.C., battery, universal, auto, F.R.F., super heterodyne, all-wave and other types of sets. And a cross reference system gives you the probable cause and a quick way to locate and remedy these set troubles. A special section is devoted to receiver check-up, alignment, balancing, neutralizing, testing.

GOOD FOR BOTH 64 PAGE BOOK SAMPLE LESSON FREE

J. E. SMITH, President, National Radio Institute Dept. 1KX, Washington, D. C.
 Without obligating me, mail your Sample Lesson and 64-page Book FREE. I am particularly interested in the branch of Radio checked below. (No salesman will call. Write plainly.)

- Radio Service Business of My Own
- Service Technician for Radio Stores and Factories
- Spare Time Radio
- Operating Police Radio Station
- Auto Radio Technician
- Aviation Radio
- Operating Broadcasting Stations
- Army, Navy, Radio
- Operating Police Radio Stations
- Operating Ship and Harbor Radio

(If you have not decided which branch you prefer—mail coupon for facts to help you decide.)

Name
 Address
 City State 14X1

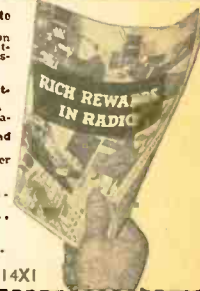

RADIO-CRAFT

HUGO GERNSBACK, *Editor-in-Chief*

N. H. LESSEM
Associate Editor

THOS. D. PENTZ
Art Director

R. D. WASHBURNE, *Managing Editor*

IN THE NEXT ISSUE!

- Interference Analysis and Its Radio Reception Effects
- The Trumpet Loud-Speaker
- More New Receiver Circuits
- Design Factors of an Unusual 70-35 Watt Amplifier
- New R.C.A. Automatic Record Changer—How It Works

Contents **OCTOBER, 1941** Issue

VOLUME XIII -- NUMBER 4

Mailbag	195
Editorial: Radio Broadcast Warfare	Hugo Gernsback 201
The Radio Month in Review	202

SERVICING

Putting "Oomph" into Receivers	Nathan Grossman 205
Substitute Materials in the Recording Industry	209

RADIO SERVICE DATA SHEETS:

No. 316—Crosley Models 82 CP and 82 CQ (Chassis No. 75)	212
No. 317—Detrola A.C./D.C. Model 3271 Series	213
Chart Indicating Tube Failures	214
Operating Notes	Bertram M. Freed 216
A Simplified Channel Analyzer	D. H. Prewitt 218

F. C. C.

Policing the Kilocycles	220
-------------------------------	-----

SOUND

A Modern 50-Watt P.A. Installation	L. M. Dezettel 222
Sound Engineering—No. 22	A. C. Shaney 226
F-M Stations Increase	227
14-Watt P.A. and Recording Amplifier	Bruce Broyles 229
High-Gain Battery-Powered Amplifier	George F. Baptiste 230

F. M.

F.M. Service—Part II	Bertram M. Freed 233
----------------------------	----------------------

RADIO DEFENSE

New Radio Opportunities in the U.S. Naval Reserve	237
---	-----

ENGINEERING

Power Factor Correction	238
Reducing Phono Tracking Error	Wm. I. Powell 240

ELECTRONICS

Servicing Music Instruments	242
-----------------------------------	-----

TEST INSTRUMENTS

Direct-Reading V.T. Voltmeter	Stephen J. Varnecky 245
-------------------------------------	-------------------------

DEPARTMENTS, ETC.

Mailbag	195
Book Reviews	199, 256
Radio Month in Review	202
Radio Service Data Sheets	212, 213
Operating Notes	216
Sound Engineering,	Conducted by A. C. Shaney 226
Latest Radio Apparatus	249
Classified Radio Directory	250
Technical Review of Catalogs	255

★

Published by Radcraft Publications, Inc. Publication office: 29 Worthington Street, Springfield, Mass. Editorial and Advertising Offices: 20 Vesey Street, New York City. Chicago Advertising Office: RADIO-CRAFT, 520 North Michigan Avenue, Chicago, Ill.

RADIO-CRAFT is published monthly, on the first of the month preceding that of date; subscription price is \$2.50 per year in U. S. (In foreign countries, 75c additional per year to cover postage; Canada, 50c additional.) Entered at the post office at Springfield as second-class matter under the act of March 3, 1879. All communications about subscriptions should be addressed to: Director of Circulation, 20 Vesey Street, New York, N. Y.

★

Foreign Agents:

London—Gorrings' American News Agency, 9A Green St., Leicester Square, W. C. 2, England.

Paris—Messageries Dawson, 4 Rue Faubourg, Poissonniere, France.

Melbourne—McGill's Agency, 179 Elizabeth St., Australia.

Dunedin—James Johnston, Ltd., New Zealand.

★

Text and illustrations of this magazine are copyright and must not be reproduced without permission of the copyright owners.

★

Copyright 1941 Radcraft Publications, Inc.

OL' TIMER

Dear Editor:

While looking over some old numbers of *Radio-Craft* I came across your Jubilee Souvenir Number, published in 1938, for the first 50 years of radio. This number brought to me some remembrances of the old days of crystal detectors and multiple wire antennae.

Perhaps you remember me, perhaps you do not, but many times in my endeavors to get adequate reading material for keeping up with the rapid advance of radio I dropped around to your office to get books that could be understood, not going into higher mathematics to explain how a vacuum tube worked.

Around the early '20s I made up my mind while still in the 5th grade to study radio and be a commercial operator. Being handicapped by the limited education, one look at "How to Pass," and other books, gave me the jitters. You know us commercial men of those days. We could not be kept down; so I kept on looking for simple and at the same time informative books.

Finally a friend of mine happened to have a book he just bought and since he realized the commercial end of radio did not appeal to him he sold me the book for (I will never forget) the grand sum of \$2, which I borrowed and worked out later. Those \$2 constituted the most profitable investment I ever made, for a couple of years later I took the commercial exam and passed with a mark of 85%. Do you remember your "Wireless Course in 20 Lessons"? That book had the most simple and understandable explanation of how vacuum tubes and the innumerable uses worked; so much so that years later when the transition from spark to vacuum-tube transmission came around I had no trouble adapting myself to the new conditions. Especially, perhaps you remember when the old 1st Class tickets were recalled and new examinations had to be taken by those desiring to hold the top license.

I feel that the commercial seagoing fraternity owes you a great debt of gratitude for your easily understood publications as well as the developing of radio receivers and the predictions which pushed manufacturers towards improving their products and thereby giving the consuming public more for their money.

Perhaps I am taking too much for granted, Mr. Gernsback, but may I in the name of the operating profession offer my greetings to you and those you mentioned on that Jubilee as the men who created and kept up my line of endeavor in life.

E. GORBEA,
Jupiter, Fla.

MOODY IS MOODY AGAIN

Dear Editor:

On reading some of the letters sent in by a few old fogey readers, I have reached the conclusion that there are a number of people who stopped thinking 10 years ago. They have been in Radio since way back when . . . and they've stood still ever since, until their brains petrified. These Rip Van Winkles of radio, prodded to consciousness by a fellow (me!) whom they accuse of having an ego, find their only possible response is patronizing indulgence, which is conceited and egoistic in itself.

WILLARD MOODY,
New York, N. Y.

BOUQUETS FROM "DOWN UNDER"

Dear Editor:

I have often been going to write to you in regard to the magazine but never seemed

to get sufficient time. The greatest improvement in the magazine since the special monthly issues were instituted is the streamlining, as it was very annoying to have to turn to the back of an issue to complete an article.

Another improvement that would be worthwhile, if it would be possible, is to publish an index in June covering the last 12 months; then it would be possible to look up anything and find it with ease.

I am not in favor of any "ham" articles as there are several magazines which cater to this class of thing, and then again *Radio-Craft* is recognized the world over as being the leading Serviceman's magazine, so let us keep that position. I have been practicing in the Servicing and Sound Engineering fields for many years and can definitely state that the assistance that I derive from *Radio-Craft* has been invaluable.

J. BRASSIL,
Mount Isa,
Queensland, Australia.

Thank you for your comments. We are especially glad to know, Mr. Brassil, that *Radio-Craft* has been of real value to you in your service work.

CORRECTION:

BUCK & SIMPSON

Dear Editor:

With regard to my recent letter, "Buck Gets a Vote," which appeared in the August 1941 "Mailbag," there is a slight error which might be confusing to some Servicemen, *id est*, the expression "1,500-f2 (440) or 620 kc." should be "1,500-2 (440) or 620 kc."; the expression "1,500-f2 (456) or 588 kc." should be "1,500-2 (456) or 588 kc."

JOHN R. SIMPSON,
Gainesville, Fla.

HEARING-AIDS

Dear Editor:

Referring to the May, 1941, issue of "R.-C.," pgs. 645, 646 and 647, with respect to hearing-aids, the remarks of Mr. Kefer were most interesting; as well as the remarks of Mr. Russel and Mr. Cisin in a previous issue.

I am another of your deaf readers who always first looks in *Radio-Craft*, and *Radio & Television*, for something of interest or help for a deaf person. I first noticed my deafness when a young man about 50 years ago. Several years ago I asked the late Mr. Dyer, who had been associated with Mr. Edison for many years, why he (Edison) had not given the deaf public something of value to them and he said that "Mr. Edison did not care. It was the other fellow's misfortune if he failed to make him understand." My belief is that this was a nut that even Mr. Edison could not crack.

I use a series of paper tubes with which I can hear normal talk from 3 to 15 feet away; I carry a small one in my pocket for service about 5 feet away. Without them I cannot hear under a shout more than 5 inches away. It has been well known for many years that words spoken at a normal pitch into a confined air space may be heard for a considerable distance even by the deaf if conducted directly to the ear drum.

It may be interesting to know that the *Victrola* so popular a few years ago was the result of work relative to the deaf. I filed a patent application in 1907, which issued in 1922, with broad claims covering the *Victrola*, which the old Victor Talking Machine Co. attacked, but the United States Supreme Court affirmed my title in 1929. In spite of the favorable outcome I never

SPRAYBERRY TRAINS YOU for GOOD PAY! STEADY WORK! ADVANCEMENT! in RADIO and TELEVISION

DON'T WAIT! START NOW!
You Can Make Money Almost At Once
You'll be quickly shown how to get and do neighborhood Radio Service jobs . . . for practice and profits. You easily learn Television (Auto-Tank) Aviation Radio, Electronic, Mobile Radio, Radio Set Repair and Installation Work. I'll Prepare You Quickly in Spare Time At Home Or At Camp

SPRAYBERRY Training does not interfere with your present work. You will receive personal coaching service all the way. You'll be able to hold down a good paying job in Radio or to have a Radio business of your own.

You Get Professional Test Equipment
Plus Experimental Outfits (to build complete Radio Receiver), RADIO TOOLS and a TESTER-ANALYZER. MY EXPERIMENTAL OUTFITS enable you to conduct actual experiments with your own hands.

NO EXPERIENCE NEEDED
It makes no difference what your education has been. I can fit you to become a real RADIO TECHNICIAN. Your success is my full responsibility.

THE SPRAYBERRY COURSE IS SOLD UNDER MONEY-BACK AGREEMENT

RUSH COUPON for BIG FREE BOOK

SPRAYBERRY ACADEMY OF RADIO
Sprayberry, President
420-K University Place, N. W.
Washington, D. C.

Please Rush me FREE copy of "HOW TO MAKE MONEY IN RADIO."

Name AGE
Address
City State
I enclose develop or paste coupon on penny postcard

QUICK, EASY WAY TO TRAIN FOR RADIO in 8 WEEKS

H. C. Lewis

I'LL FINANCE YOUR TRAINING
Mail the Coupon TODAY and I'll not only tell you about my quick, easy way to train for a good pay job in Radio, Television and Sound, BUT, I'll also tell you how you can get it and pay for it, in **EASY** monthly payments starting 60 days after 8 weeks' training period.

LEARN BY DOING
On Real Equipment in Coyne Shops
Simple, easy method of Practical Training. You don't need previous experience or a lot of book learning. You work on real equipment in the Coyne Shops at Chicago. This 8 weeks training prepares you for a job in service and repair work—we also offer radio operating training. Full details of this training will also be sent you when you send coupon.

EARN WHILE LEARNING. Job Help After Graduation
We help you get part time work to help with living expenses and then give you employment service after graduation.

H. C. LEWIS, President,
Radio Division, Coyne Electrical School,
500 S. Paulina St., Dept. 71-8H, Chicago, Ill.

Dear Mr. Lewis:
Please send me your Big FREE Book, and details of your PAY-AFTER-GRADUATION-PLAN.

NAME
ADDRESS
CITY STATE

SEND COUPON TODAY

COMMERCIAL RADIO INSTITUTE

A radio training center for over twenty years. Well equipped, Excellent faculty. Practical resident courses in Radio, Telegraphy, Broadcast, Servicing, Industrial, Television, Aeronautical, Drafting, Mathematics and Studio Technique. Placement bureau. Fall classes now forming. Catalog upon request.

Dept. D, 38 West Biddle Street, Baltimore, Md.

•MAILBAG•

received a cent in payment of the great expense that they put us to in defense of my title. In 1922, I filed a radio application, the last division of which issued in 1933. Both cases were involved in about a dozen interferences after having been rejected by the experts of several large companies.

In January, 1940, I was looking over some of the old issues of your publications and I noticed an article, on pg. 605 of the April, 1939 issue of *Radio-Craft*, "How the Beam-A-Scope Works." Later I found about a dozen companies were using apparatus which included movable, self-contained loops, and electric phonograph sound recording and reproducing devices, covered by my patent claims. I sent out 5 or 6 infringement notices in March, 1940, and after the usual delays I found they (presumably the companies—Ed.) had all ganged up on me and denied that they were infringing any VALID claim. The patent lawyers of 4 different firms advised me that the Federal judges were not sustaining patents and that I had better take any reasonable settlement rather than take a chance with my 4 patents some of which were over 10 years old.

The RCA were as well aware of this condition as I, but with justice to them they did not take advantage of it and offered a substantial amount above my expenses relative thereto, taking over the patents. I received their check Christmas morning, 1940.

I consider that RADIO-CRAFT was directly responsible for the sale of my patents. It would be a good idea for radio inventors to watch your publication.

There has been much loose talk of amending the patent laws. I think it would be a good idea if you would publish some of the proposed bills with your comment as an aid to your readers. I believe that the law should be changed requiring the filling-in by inventors—first their disclosure and drawing, and from time to time a statement with respect to diligence and public use which would become part of the file when the patent application is filed. In the event of an interference, the *Interference Examiner* could render a decision in a few hours based upon the record on file instead of having to wait over 20 years as in my case!

Every once in a while I would find myself reading that old April fool hoax of 1933. ("The Westinghouse Receiver," May issue.—Ed.) With the reduction in voltage or size of the "B" batteries and with the new tubes mentioned, a real pocket-size hearing-aid is in sight. I believe your readers would appreciate your comments on the next step in the Phono-vision Art; that is, changing both light and sound values to electrical values, and recording the result by a single stylus on a disc record, 20 to 30 inches in diameter, moving at an even tangential speed of 200 to 400 grooves to the inch. A home record of a talking moving picture of an hour's duration would result.

JOHN B. BROWNING,
Camden, N. J.

PHASE INVERSION CIRCUIT

Dear Editor:

In the "Mailbag" of August *Radio-Craft* appeared a letter by Mr. Otto Schmidt, referring to a *phase inversion circuit* using a grid connected to ground and a common cathode connection for phase inverter and 1st A.F. amplifier.

The writer has had some practical experience with this circuit and found it difficult to equalize the voltages on the following push-pull grids. That is, the phase inverter tube had a lower output than the 1st A.F. amplifier, and the system was un-

balanced; or, the opposite would be the case. The gain was very low and the frequency response poor.

A better circuit is that used and developed by RCA and shown in the attached drawing. This circuit uses one tube as a first A.F. amplifier and a second tube as the phase inverter.

A practical setup would be two 6J5 tubes, using 250 volts "B" supply and plate resistors of 50,000 ohms, making 100,000 total from 6J5 plate to 6J5 plate. The grid condensers should be 0.25-mf. for good low-frequency response and a flat curve. The control-grid resistors are 100,000 ohms each, or 200,000 ohms from grid to grid in the push-pull stage driven by the phase inverter system. These are R1 and R2 in the diagram. The cathode resistance in the 6J5 circuit will depend on the input signal and may be about 2,000 ohms for a phonograph input of 1 volt. The input grid resistance to V1 would then be about 100,000 ohms. A high-resistance gridleak will raise the low-frequency response of the amplifier and vice versa. Resistor R3 should be a 100,000-ohm unit.

WILLARD MOODY,
New York, N. Y.

HOW THE MAILBAG GROWS!

By leaps and bounds—from 2 columns to 12 columns—the Mailbag Department just keeps growing. And it's a good, healthy sign, too. It's an excellent indication that the family of *Radio-Craft* readers are taking an increasingly large interest in their magazine. This is the only way that *Radio-Craft* can continue to improve!

Keep up the good work fellers! Also, let's hear from those who merely read this Department—the silent members of our family. This is the one place in the magazine where you can speak your mind freely—and don't mince any words!

Speak Up Brothers and Ye Shall Be Heard!

INCANDESCENT LAMP HUM

Dear Editor:

Last Wednesday evening while listening to my radio set I noticed a peculiar phenomenon. When a certain table lamp was on there was an unbearable hum in my "radio," although I was listening to a strong local station. When this lamp was off, the hum disappeared. The bulb when examined proved to be a Montgomery Ward 150-watt globe, and when it was replaced by a new bulb, the hum disappeared. Can you explain this?

I read Mr. Gernsback's editorial this month (August) with interest. However, I believe that he is getting ahead of himself a little.

The contents of *Radio-Craft* is rather comprehensive, but it seems to me that if a long-sighted policy were adopted for home-constructed test instruments it would be an addition well worthwhile. If, for example, at least one article should appear in each issue which dealt with the construction of such instruments with the view of eventually completely equipping a service shop or even a radio laboratory, it would be a distinct help to certain readers.

ROBERT STEELE,
Camp Barkley, Tex.

MOODY VS. HARRIS

Dear Editor:

I will not deny that I like *Radio-Craft*—its features, its letters from readers—but when I offered the suggestion that the letters be deleted it was not that I didn't want the letters but did want the more important editorial material to stand out and be readable. A magazine has just so much space and everything that an editor might want to print cannot be gotten in.

But perhaps I was wrong. A man can be wrong, and he is a man if he is willing to admit that he can be wrong. He is open to new ideas. He is not an old-fashioned and reactionary fogey. He doesn't sit back and let others pull the whole load. He contributes, as best he can, to the advancement of the art in which he is interested and from which he derives a livelihood. To Mr. Harris of Delta, Colorado, I say I am such a man.

Now let us ask this gentleman from Colorado what he accomplished in radio at the age of 24 or 25. Is he still in the same old rut? Was he a practicing engineer engaged in manufacturing important Signal Corps equipment and standard radio? Was he a 1st class commercial licensed radio telephone operator and a member of I.R.E.? What did he contribute in his small way to magazines and the betterment of radio men to the best of his ability? Did he study for long hours at night to gain engineering knowledge the hard way?

WILLARD MOODY,
New York, N. Y.

EXTOLLING THE AMATEURS

Dear Editor:

The letter of Edwin A. Wolf, of West Roxbury, Mass., published in the August issue, cannot go unchallenged. The contribution of the amateur to radio is something that any intelligent radio man, whether service expert, engineer or anyone connected with radio, is fully aware of and grateful for.

Amateurs have performed meritorious service in time of disaster, whenever an emergency big or small developed and needed to be met. Now, in the face of war, when this country's way of life is threatened, thousands of amateurs have entered the armed forces of this nation, ready, willing, able to do their share and pull their load. A radio amateur may not be the best technical man in the world, but has one very important ability. It is the knowledge of the International Morse Code and the ability to transmit and receive that code that makes the amateur valuable. Many hams, in addition, have technical knowledge superior to that of professional engineers and many, indeed, are practicing radio or electrical engineers. The *average* ham, in short, has more value to the government and can do a better job than the *average* professional Serviceman who knows only radio receivers and not too much about them.

Let this Mr. Wolf try to get a ham license—just see whether he can make the grade! To get a 1st Class Phone or 2nd Class Radiotelegraph "ticket" in the commercial field, he will really have to sweat.

WILLARD MOODY,
New York, N. Y.

And this from a former Serviceman! However, the hams, or transmitting amateurs, do rate tops.—Editor

WHAT OHMAGE VOLUME CONTROL?

Dear Editor:

Two more defects, not commented upon, in "The circuit which troubled Mr. Sherwood and his friend," as shown at the bot-

tom of page 324 of December, 1940, *Radio-Craft* are the following:

First: the gridleak return should go to the "A+" filament leg of the type 30 detector since the "low" side of L2 is connected to "A-".

Second: the 25,000-ohm volume control shunted across the section of the audio transformer is too low in value for the average transformer and cuts down the amplification too much (a value of 0.1- to 1 meg. would be better here).

A variometer could be inserted at X2, permitting dotted variable C to be replaced with a fixed condenser (the 0.002-mf. unit across the phone jack could be used, or another one of 0.001- to .002-mf.). With feedback control, volume control is not really necessary and could be eliminated.

JOHN C. BARNHART,
Sunbury, Pa.

Mr. Barnhart's arguments on the circuit of Mr. Sherwood, *et al.*, are interesting but not necessarily conclusive.

For example, if somewhat less sensitivity is permissible with increased tone quality as the reward, it may be quite OK to utilize the negative return circuit for the detector as shown in the diagram. While it is true that the amplification probably would be lowered (depending to a certain extent upon the individual tube characteristics), at the low plate voltage indicated, the tone quality of local-station reception would be improved.

While it is true as Mr. Barnhart states that the 25,000-ohm volume control is shunt to the secondary of the coupling transformer and would result in reduced amplification, here again it is true that the tendency would be to flatten the overall response characteristics of this amplifier stage with the result that the bass and treble response would be improved. Both of Mr. Barnhart's suggestions are in line with achieving greater sensitivity; and in the latter instance it is probable that increasing the value of the volume control to at least ¼-megohm would considerably improve the voltage gain of the output stage.

The use of regeneration at X2 would be a revelation to Mr. Sherwood and his friends, but probably his neighbors in Bridgeport would not appreciate the improvement inasmuch as only the experienced operator of such a "blooper" circuit would be likely to handle this regeneration control without causing "beeps" in nearby receivers. However, with the circuit modified as Mr. Barnhart suggests the volume control probably would still be a necessity in Bridgeport, to prevent cross-modulation of strong locals, where station congestion is probably greater than in the vicinity of Sunbury.—*Editor*

BUCK AGAIN

Dear Editor:

I have been wondering if you will ever realize how wrong your method of superheterodyne alignment is. To make sure that you will realize just that, I went through the trouble of writing this letter.

Your method is correct only in case the oscillator is properly aligned. Since this is rarely the case, your method is rarely correct. You work under the assumption that between 1,500 kc. and 588 kc. on the dial there is a change of twice 456 kc. in the oscillator frequency which is true only in case the I.F. is aligned to 456 kc. and the oscillator is adjusted accordingly. But the I.F. is the thing you are looking for, so what makes you think you will ever hit 456 kc.?

Let us take a practical example:

Suppose the I.F. has been mistuned so it peaks now at 420 kc. instead of 456 kc., but you don't know about it. Also your oscillator trimmer and padder have been so adjusted that WTBK comes in at 1,500 kc. and its image in the neighborhood of 588 kc. which is possible since the oscillator has a 2-point adjustment. Now the distance on the dial is still 1,500-588=912, or twice 456; but the oscillator frequency is 1,500-420=1,080 kc. instead of 1,044 kc. From now on you can go about peaking your I.F. to your heart's content and its frequency will remain 420 kc. As a result you will get WTBK at 1,500 kc., and its image at 588 kc., but everything else is going to be slightly off and sometimes more than slightly.

The thing gets more painful and accuracy gets more doubtful when you try to adjust the set by tuning-in to a direct signal instead of its image.

The trouble with you is, Mr. Buck, that you have two variables (the intermediate frequency and the oscillator frequency) and you try to solve the problem without having one given; and you should know from mathematics this is impossible.

I think you'd be better off using a reliable signal generator for your alignments, and to make sure the frequency of your signal generator hasn't changed you'd better check up on its frequency from time to time by beating its signal with some standard frequency on the broadcast band.

JOEL JULIE,
New York, N. Y.

RE: TREASURE LOCATOR

Dear Editor:

In reference to the Dec., 1940, issue of *RADIO-CRAFT* I would like to ask the author a few questions regarding his ore locator.

What real tests were given it, as to different minerals?

What is the extreme depth of any known mineral, and what mineral was indicated?

C. W. STEPHENS,
Prescott, Arizona.

This letter was forwarded to the author whose reply follows:

Dear Mr. Stephens:

Your letter in care of *Radio-Craft* has been received.

I have not checked the Locator described in the December issue on any minerals. That is, mineral deposits as they are found in the earth. The locator has responded to metals: aluminum, brass, copper, lead, and iron, in tests made by me with no noticeable difference in any of these metals when tested under the same conditions. The most of my tests for depth have been on buried water lines and oil pipe lines.

A ½-in. iron water line is easily located 18 ins. deep, a 4-in. iron water line 5 ft., and a 12-in. line 11 ft. deep. There was a deflection of half the meter scale and more on these tests, as well as a strong signal in phones.

G. M. BETTIS,
Sweetwater, Texas.

ENGINEERING PROBLEMS

Dear Editor:

The engineer is faced with the necessity of getting out receivers on short notice, and it is no wonder that many of them subsequently become of little value. Part of this may be laid at the door of the owner of the manufacturing plant and part of the blame, too, may be placed upon the buying public which is too careless or non-techni-

RADIO TRAINING



Founded in 1909

PORT ARTHUR COLLEGE, a non-profit making educational institution, offers a practical radio operator's course at the lowest tuition price in its history. Each radio graduate receives two months' actual operating experience at the college's commercial broadcasting station KPAC. This station is equipped with the latest type 1000 watt high fidelity RCA transmitter—1250 kc.—directional antenna system. KPAC operates in new modern studios located on the campus.

The college has never advertised jobs or positions in lieu of education. Today it is well known there is a shortage of radio operators in every branch of radio; therefore, we believe it is good common sense to mention that Port Arthur College is the sole radio school in America which owns a commercial broadcasting station with commercial advertising representatives in New York, Chicago, San Francisco, and many of America's leading cities, with active membership in the National Association of Broadcasters, and Broadcast Music Incorporated. Through these contacts the college receives from the broadcast industry alone a great many more calls for student radio operators than it is possible to supply.

Authorized to teach RCA texts.

If interested, write for Bulletin R-41

PORT ARTHUR COLLEGE
PORT ARTHUR (World-Known Port)
TEXAS

ARE YOU "PINNED DOWN" TO A ROUTINE RADIO JOB?

- Radio JOBS are many—
- Radio CAREERS are few!

Right NOW is the time to take the "question mark" out of your future in radio! Prepare now for an IMPORTANT career in the expanding radio industry.

For more than 14 years CREI has been helping ambitious professional radiomen toward CAREERS in radio... not mediocre jobs that are available to partially trained men... but CAREER jobs that will be even more important in the years to come. The man who equips himself now with a thorough foundation of technical radio knowledge is the man who has INSURED his future in radio.

CREI Training is preparing others for better paying jobs—WHY NOT YOU?

WRITE FOR FACTS TODAY! Our FREE BOOKLET and personal recommendations may hold the answer to your future success. Write today and please state briefly your background, education and present position.



CAPITOL RADIO ENGINEERING INSTITUTE

Dept. RC-10 3224 16th St., N. W. Washington, D. C.

LES Correspondence Courses in RADIO and ELECTRICAL ENGINEERING

ELECTRICAL ENGINEERING Get good grasp of wide electrical field. Prepare yourself, at Low Cost, for secure future. Modern, simplified, you can understand quickly.
RADIO ENGINEERING Extra fine course in radio, public address, photo-electric work. Trains you to be super-service man, real vacuum tube technician. Exper. kits furnished. Diploma on completion. Tuition, \$25. either course. Deferred payment plan. Get copies of school catalogs, student magazines, complete details. SEND NOW!
FREE

LINCOLN ENGINEERING SCHOOL, Box 831-834, LINCOLN, NEBR.

cally minded to look at a "radio" and inspect the chassis. That is why we have allwave and 2-band sets with dead spots and lousy calibration, radio receivers with tubes that burn out too soon and service troubles that are terrible. Believe me, as a former Serviceman and now as an engineer I can appreciate the problems involved; and, I think, the only way out is price control by a league of manufacturers.

The trouble today is that not enough engineering is going into radio sets. Further with the shortage of materials due to the large-scale usage of Defense materials, such as aluminum, many more problems are going to present themselves for solution and chief amongst these is an adequate and satisfactory substitute for aluminum condenser.

If manufacturers themselves had to service some of the sets that are being turned out today, you can be sure that the radio receivers would be a great deal more accessible than they now are and that they would be built better. Now, don't get me wrong, but I do believe that contact between manufacturers and the public is too slight and casual. Sets, for example, are slapped into cabinets without due regard for the problems involved in subsequent servicing which is sure, at some time or other, to be needed. Condensers of the electrolytic variety, for example, might well be mounted on tube socket plugs, so that they could be replaced readily in the event of failure. The Serviceman would benefit by such an innovation, since repairs would be made easier for him and less time would be lost in soldering and unsoldering connections as at present is the case.

Resistors, condensers and other parts are jammed into some sets in such manner that it is impossible to make head or tail of the mess without a good deal of effort. In the old days, the days of Atwater Kents, for example, sets were made that were good, that were built to last. Today the emphasis is on flimsy, cheap construction. Many of the old-time radio sets were built better and are still playing today whereas many of the new sets have long since "conked out" or have been afflicted with a variety of burned-out resistors, shorted condensers and noisy volume controls.

The public has come to look upon the radio Serviceman as some kind of clever crook, and this is justified in many instances, since the Serviceman has been forced to resort to cheap tricks to earn a lousy livelihood. The skilled, able technicians of the service trade are not able to get a decent wage, decent hours and a way of life comparable to that of a skilled electrician or bricklayer. A Serviceman must know more than any electrician, must be highly trained to do a good job, and yet he is far from well off today.

Conditions in the industry may be blamed unequivocally on those manufacturers who sell through illegitimate cut-rate distributors and retail dealers. The list price of a radio receiver has got to mean something! Once that price to the public is jacked-up the Serviceman will be able to earn a real livelihood. Wages are going up, in this war boom we now find ourselves in, and prices inevitably will rise. You may call it inflation; call it what you will, but the fact remains that all manufacturers must establish the sanctity of the list price and that cut-rate retail outlets must be outlawed.

Today we have in existence places of business that operate on a 10% margin, that sell radio sets and other merchandise "at a discount", that purport to offer good service to the public but which in reality force down prices and prevent the realization of a living wage for all concerned.

The manufacturer is doing the best that

he can. Radio receivers, considering the price paid, are superior. But they are not good enough. They are too cheap and anything cheap is no good. The middleman with his necessary profit cannot be eliminated in any distribution setup and must be retained. Since this is so, the only alternative is an increase of the list price and maintenance of that price, sans discounts and illegitimate knockoffs. Better engineering will then follow. The industry will benefit and the public will lap it up if it is properly sold to them.

The engineer is limited by the price factor. He labors to produce a receiver that is good as possible at a certain price. He puts a certain number of tubes in the thing because the boss employer tells him the set must have so-and-so many tubes and the hell with the electrical design. The set is designed, further, to fit a cabinet and not the cabinet to fit the set. That's the way it goes. Elimination of low-cost sets and more time for engineering are needed to produce quality.

WILLARD MOODY,
New York, N. Y.

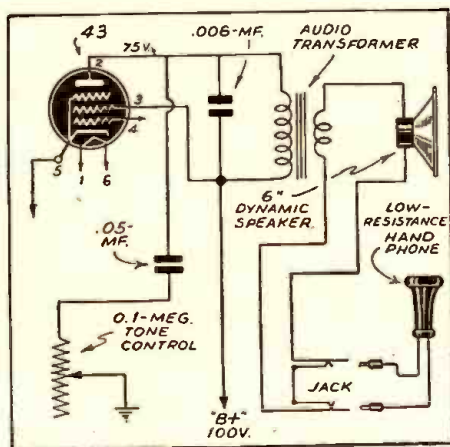

Simple Headphone Connection.

HEADPHONE CONNECTIONS

Dear Editor:

If a mere listener is allowed to say anything to the experts about tapping small radio receivers for headphone, I say, "get a radio with plenty of tone control!"

I invested nearly 2 bits in a "shorting-type twin-jack" and a couple of "Fahenstock double clips"; bored 2 holes through the front of the cabinet, and connected the jack in series with the voice circuit. That is, I cut one of the two wires that run from the speaker to the audio transformer, put the clips on the cut ends and connected them to the jack terminals. Both phone tips have to be in the jack to stop the speaker (or practically stop it).

I can get enough bass to make good music on any old kind of phones (see diagram). Impedance values up to 4,000 ohms don't seem to cause any distortion, although I got distortion when turned on loud enough to be heard with the phones under the pillow (for all-night news, May 10, 1940).

But many newer radio receivers do not have enough range of tone control, even for their own loudspeaker. You can't put enough bass in some of the music, nor enough treble in some of the voices (even voices that are not relayed from Berlin).

Who will tell me the best way to increase the range in small "radios" that have some tone control?

GILBERT S. WALKER,
Pittsburgh, Pa.

THE RADIO TECHNICIAN SHOULD ANALYZE HIMSELF TO IMPROVE THE RADIO TECHNICAL STATUS

From the article in the *Readers' Digest* of August, 1941, I derived the urge to write this analysis of the radio service business and the Serviceman Technician as we choose to be called.

That article claims that "64 per cent of the technicians in the U.S.A. are truly gyps." This might apply to Canadians. Certain paragraphs imply that it is robbery to charge \$3 or \$4 for replacing a 5c part in a receiver. It mentions that when certain technicians were accused of crooked service methods, they simply said, "We have rent to pay" or "We have light, phone and taxes to pay."

The technicians' difficulties are here in a nutshell. The Radio Service profession has not had the insight to see and ask themselves the why and wherefore of their troubles. This is mainly because they have an inferiority complex when it comes to rating their value as technicians on the open market. Due to this fact, the present-day technician has to sell the public something mysterious. This is because the customer has been educated to ignore the Radio Technician's ability and to consider the parts replaced as the only cost on a service job.

This is the technician's own error, as I said before, due to his lack of self-esteem, self-confidence or inability to sell his worth. We must change and change soon.

The doctor is often used as an example to value the radio technician's service. His training is longer and this provokes an argument, so we will leave this. But the dentist's services may be used, e.g.:

Filling one tooth.....	\$3.00
Cost of material.....	.25
Training period (approx.) 3 years.	
Prestige and self-esteem high and saleable.	

The printer:	
One printing job.....	\$8.00
Cost of paper.....	1.50
Training period 3 years.	
Prestige and self-esteem high and saleable.	

Publishers, manufacturers, opticians, and nearly all vocations can be analyzed in a similar manner.

Radio Technician:	
Service job.....	\$4.75
Cost of material.....	.25
(Training period 3 to 6 years.—Editor, Radio-Craft)	

Prestige fair or low; self-esteem high among his own kind and very low on the public market. This is due, as we said before, to the fact that he is usually afraid to try to sell himself and his service honestly and at a high figure.

The dentist is entitled to his \$3, the printer to his \$8, and the radio technician to his \$4.75 for their service rendered because of the following data:

"The charge to a customer should be sufficient to pay all cost on the job and a legitimate profit."

Approximate but close figures on the operation of a small shop in Vancouver in 1940. These figures compare closely with other shops of similar size in Canada and the U.S.A.

Cost of doing business per day, including proprietors, transportation, etc.	\$25
Cost of parts per day	11

Total	\$36
-------------	------

This amount must be averaged and accounted for every day in service and the merchandise that accompanies it (excluding receivers). This is purely a service organization.

There are 3 Technicians in this shop. Be-

tween service calls where the customer is not at home as promised; where the customer wishes to chat; pick-up and delivery of parts; arranging business ads; compiling direct mailing lists, etc., the men average about 3 complete service jobs per day apiece or nine in all, at \$4 per.

To do this he must keep going because in the busy season he must nearly double this in anticipation of the slack period.

Could he bill a resistor job as follows?:

Service\$1.00
Parts25

"He certainly could not."

During the busy season he has to turn over about \$55 to \$60 a day to get by WITHOUT the legitimate profit (in fact, without any profit at all).

Therefore this shop must charge from \$2 to \$3 per hour. Articles as written by our best teachers and other members at the top of the profession insist that \$2 to \$3 per hour must be charged on service work

and these figures can be verified.

ALL technicians must realize this and ADVERTISE IT before they can gain the confidence of the public as the dentist and printer, etc.

If they resort to trickery and to trimming their bills to look mysterious and expensive, they will sooner or later run into trouble and the whole profession is suffering every day because the inexperienced are doing it crudely.

The only few who do not have to do this are very fortunate and have a sales department to pay their expenses.

I would like to mention too that any equipment found in any service shop that is not needed or used to any extent by the technicians on service work (that might be called Rube Goldberg equipment) is there due to high pressure equipment salesmen or is not used because of the technician's lack of understanding of the instrument.

FRANK DAVIS.

BOOK REVIEW

HOW TO BREAK INTO RADIO. by Robert DeHaven and Harold S. Kahn (1941). Published by Harper & Brothers. Cloth covers, size 5 3/4 x 8 3/4 ins., 162 pages. Price \$2.

Robert DeHaven as Production Manager of WTCN, Minneapolis, has interviewed hundreds of radio aspirants and thus knows his subject from a practical viewpoint. Kahn is the author of 2 popular books "New Business Opportunities for Today" and "How to Make the Most of Your Life." Together these two men have produced a book which tells young men and young women how to go about obtaining employment in radio.

The book offers critical appraisal of the radio broadcast and television industry as a whole. A particularly inspiring chapter is Chapter XII, "How Others Broke into Radio" which tells how announcers, directors, etc., of various radio stations obtained their present employment.

Contents (chapter headings): Chapter I, The Lucrative Radio Field; Chapter II, Executive and Specialized Jobs; Chapter III, Jobs! Jobs! Jobs! Where Do You Fit In?; Chapter IV, How to Get Radio Experience; Chapter V, Should You Attend a Radio School?; Chapter VI, How to Apply for a Job; Chapter VII, So, You Want to Be an Announcer!; Chapter VIII, Writing for Radio; Chapter IX, Getting a Start as a Radio Artist; Chapter X, Have You a Program Idea to Sell?; Chapter XI, Television and Your Future; Chapter XII, How Others Broke into Radio; Chapter XIII, Miscellany.

ELECTROLYTIC CONDENSERS. 2nd Edition, by Philip R. Coursey (1939). Published by Chapman & Hall, Ltd. Cloth covers, size 5 3/4 x 8 3/4 ins., 190 pages. Price \$2.40.

It is worthwhile to note that a few errors in the first text have been removed; and suggestions to increase the general utility of the book have been incorporated. Anyone having anything to do with fixed condensers, particularly those of the electrolytic type, will find this book highly instructive. Information concerning the "etched" form of dry condensers; the so-called "surge-proof" dry condensers; and the latest forms of "wet" condensers, is presented for radiomen in general. Special consideration given to the general application of the newer types of condensers.

The 9 chapters in this book divide the subject matter into as many discussions of the theory of condensers and dielectrics, origin, testing procedure, detailed analysis of the construction of the several types, examination of the separator, analysis of the electrical characteristics, and, in conclusion, an extensive section on applications.

ALIGNING PHILCO RECEIVERS. Vol. 2, by John F. Rider (1941). Published by John F. Rider Publisher, Inc. Cloth covers, size 5 x 8 3/4 ins., 192 pages. Price \$1.60.

Volume I, reviewed in a previous issue of Radio-Craft, covered only Philco Receivers up to 1937. This Volume II carries on from there.

In correlating the instructions and the chassis layout of various essential components, aligning instructions, etc., the tabular form of presentation previously employed, and which tends towards speedy work, has been retained.

The widespread use of the loop antenna has necessitated a change in aligning procedure, the details of which are given in this book. The author also points out, in the appendix, many pertinent facts which tend to speed servicing. The servicing procedure for roughly 150 Philco models are given in this book.

Subject titles in the Appendix are especially interesting: Alignment Tool Reaction, Signal Strength, Output Meter, I.F. Alignment, Change of I.F. Peak, Dial Alignment, Wavetrap Alignment, Oscillator Adjustments, High-Frequency End of Band, Low-Frequency Oscillator-Rocking, Image Check, Detector and R.F. Alignment, Magnetic Tuning Alignment, 10-ke. Filter Adjustment, Repetition of Adjustments.

DIRECT AND ALTERNATING CURRENT POTENTIOMETER MEASUREMENTS. Vol. IV, one of a series of Monographs on Electrical Engineering, by D. C. Gall, F. Inst. P. 1938). Published by Chapman & Hall, Ltd. Cloth covers, size 5 3/4 x 9 ins., 231 pages. Price \$3.50.

This monograph "arrived safely thanks to British convoys," at Radio-Craft offices last month, according to a slip enclosed with this book from England; the statement was made in 12 languages.

It is the aim of the Electrical Monographs series to enable engineers, advanced students and others to obtain authoritative works on special and important subjects which are either ignored or inadequately dealt with in the text books (according to the publishers). Written by authorities in their respective fields these Monographs offer a modern survey of a particular subject; students, in particular, thus have available in convenient form material otherwise obtainable only through extensive literary research.

This book on the use of potentiometers in making D.C. and A.C. measurements speaks volumes for the persistence of the author in correlating such a tremendous fund of information on the topical subject. This book is essentially practical, little mathematical work being included. A knowledge of A.C./D.C. theory, however, is a requisite for its proper understanding.

It is too much to attempt to go into any detail in describing this book inasmuch as its coverage is tremendous. Perhaps we can best describe it as probably the most complete authoritative work on the subject of potentiometers and of its ramifications so far in print.

Hardly a book for the dilettante, it is however a "must" publication for the engineering library and a recommended volume for students in advanced radio and electricity, and those Servicemen and workers who may wish to have on hand a practical reference on the potentiometer as an instrument for the measurement of potential differences.

Chapter headings (abbreviated): Preliminary: The D.C. Potentiometer and Its Uses; Chapter V, Galvanometers; Chapter VI, The A.C. Potentiometer and Its Uses; Chapter XII, Factors Governing the Choice of a Potentiometer Circuit; Chapter XIII, The Representation of Alternating Currents by Complex Quantities; Chapter XIV, Historical Note of the Potentiometer.

(Continued on page 256)

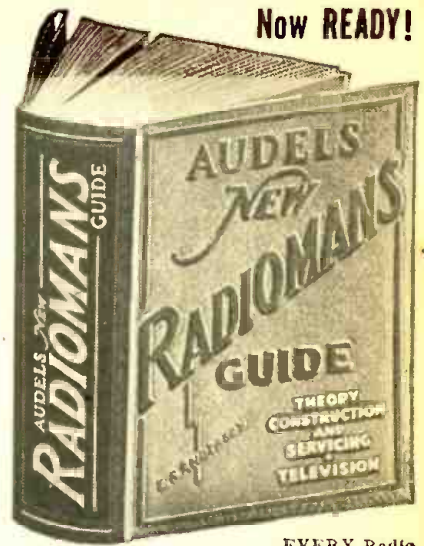

Now READY!

RADIO

EVERY Radio Mechanic—Service Man & Student Needs "Audels Radio-mans Guide"—Now Ready!
The whole subject of Modern Radio—covering the Basic Principles—Construction & Operation—Service—Repairs—Troubles—All Easily Understood. Over 750 Pages, 400 Illustrations, Parts & Diagrams

—LATE TELEVISION DATA—Valuable for REFERENCE AND HOME STUDY.

To get this practical information in handy form for yourself fill in and mail coupon today.

4 COMPLETE • PAY ONLY \$1 A MO.
AUDEL Publishers, 49 W. 23rd St., N. Y. Mail AUDELS NEW RADIO MANS GUIDE for free examination. If O. K. I will send you \$1 in 7 days; then remit \$1 monthly until price of \$4 is paid. Otherwise, I will return it.

Name _____
Address _____
Occupation _____
Reference _____ RCF

RADIO COURSES

Start October

RADIO OPERATING—BROADCASTING
• RADIO SERVICING—a practical course
• RADIO AMATEUR CODE • TELEVISION
• ELECTRONICS—1 yr. day course 2 yrs. eve. Day and Evening Classes. Booklet Upon Request.
New York Y.M.C.A. Schools
4 W. 64th Street New York City

RADIO-TELEVISION

Oldest, largest Radio-Television school in West trains you for good pay job. Complete instruction including Radio Construction and Service, Broadcast Operating, Sound, Talking Pictures, Television, Public Address, etc. Flexible Plan to meet specific needs of those with or without jobs. Transportation allowed to L.A. Earn room and board while learning. Request Free Catalog.

NATIONAL SCHOOLS Dept. 10-RC
Los Angeles

RADIO TECHNOLOGY

RCA Institutes offer an intensive course of high standard embracing all phases of Radio and Television. Practical training with modern equipment at New York and Chicago schools. Also specialized courses in Aviation Communications, Radio Servicing and Commercial Operating. For Free Catalog write Dept. RT-41.

RCA INSTITUTES, Inc.

A Radio Corporation of America Service
75 Varlek St., New York, 1154 Merchandise Mart, Chicago

Be a **RADIO SERVICE EXPERT**
LEARN AT HOME IN SPARE TIME

The demand for radio experts grows every day. Learn this paying profession under personal guidance of qualified engineer and educator. Clear, fascinating instruction and experimental kits make learning easy. Leaders in the radio industry endorse R.T.A. methods. Spare time profits soon pay for training.

FREE book telling what R.T.A. training can do for you.
RADIO TRAINING ASS'N. OF AMERICA
1859 Devon Ave. Dept. R.C. 101 Chicago, Ill.

THE "MAILBAG'S" GETTING HOTTER

The timely discussions taking place in this department each month are conclusive proof that RADIO-CRAFT is a LIVING magazine—YOUR magazine. Keep up the good work fellers! Help us give you an always-better magazine.

—The Editors

THE FINEST RADIO BOOK FREE WE EVER OFFERED :- the 1940-41 Radio-Television Reference Annual With \$1.00 subscription to RADIO - CRAFT

WITH our compliments, we want to send a copy of the 1940-41 RADIO-TELEVISION REFERENCE ANNUAL to you FREE, if you will simply take advantage of RADIO-CRAFT magazine's special subscription offer NOW. This offer is being made for a limited time only.

The 1940-41 RADIO-TELEVISION REFERENCE ANNUAL has 68 pages, large size 8½ x 11½, with over 170 illustrations. The contents of this book has never appeared before in handy book form. Its pages cover practically every branch of radio sound, public address, servicing, television, construction articles for advanced radio men and technicians, time and money-saving kinks, wrinkles, useful circuit information, "ham" transmitters and receivers, and a host of other data.

The Annuals have always been regarded as a standard reference work for every practical branch of radio operation and service. This 1940-41 edition ably sustains this reputation. Every radio man wants a copy of this valuable book. Just as this book will be of unquestionable value to you, so, too, will every monthly issue of RADIO-CRAFT. This magazine brings you big value every month. It keeps you intelligently informed about new developments in radio and television. You want the news, want it fully but concisely, want it first—that is why you should read RADIO-CRAFT regularly.

This very special offer is made for just one purpose—we want you as a regular subscriber. The Annual, whose contents appears at the right, is not sold, but a copy is FREE to you if you subscribe now.

**SAME SIZE AS
RADIO-CRAFT**

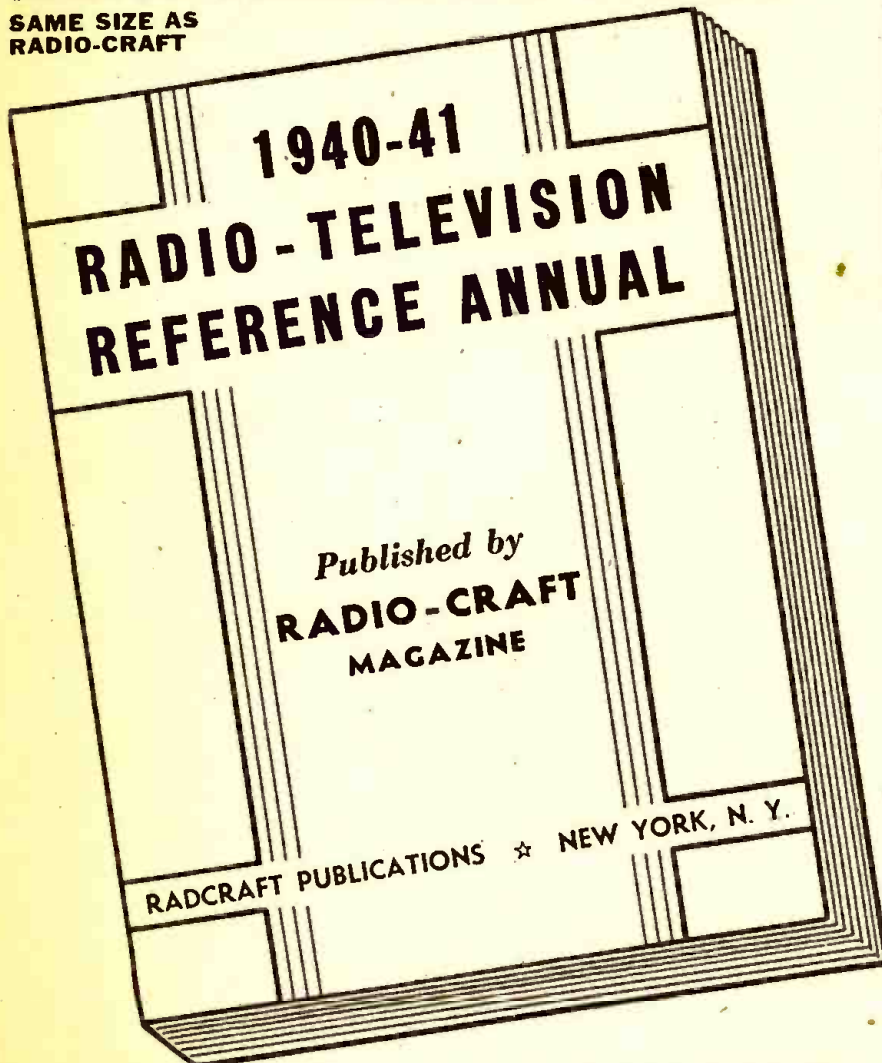

THIS COUPON BRINGS YOU THE ANNUAL

RADIO-CRAFT • 20 VESEY STREET • NEW YORK, N. Y.

Gentlemen: Enclosed you will find One Dollar for which enter my subscription to RADIO-CRAFT Magazine for Eight Months. Send me **ABSOLUTELY FREE** and **POSTPAID**, my copy of 1940-41 RADIO-TELEVISION REFERENCE ANNUAL. Canadian and Foreign Postage 30c extra.

This is a new order Extend My Present Subscription

NAME ADDRESS

CITY STATE

DON'T DELAY — MAIL TODAY! RC-1041

**Read the summary of contents
in this FREE BOOK!**

THE 1940-41 RADIO-TELEVISION REFERENCE ANNUAL contains a collection of the best and most important articles. Covering as they do nearly every branch of radio, they form a handy reference works. In addition, many time and labor-saving kinks, circuits and wrinkles, tried and tested by practicing Servicemen, experimenters and radio fans have been included. This book cannot be bought anywhere at any price. Yet it is yours by merely subscribing. Use the convenient coupon below.

**BEGINNER'S SIMPLE INEXPENSIVE
CONSTRUCTION ARTICLES**

Beginner's Breadboard Special - a 1-Tube High-Gain All-Wave Receiver—Wiring Pointers for Radio Beginners—A Watch Charm Size 1-Tube Set—Beginner's Simple Volt-Milliammeter—Mixing a 1-Tube Broadcast Loop Receiver—A.C.-D.C. Power Supply for Battery Portables—A 1-Tube Short-Waver with Band Coil Switching.

MORE ADVANCED SET CONSTRUCTION

The "High-Seas 4" Broadcast Lamp Radio—How to Build a 6-Tube 1.4-Volt Short-Wave Superhet for the "Ham" or Short-Wave Fan—Build the "Lunch Box 5" Super Set - a Broadcast Battery Portable—How to Build a Plug-Together 8 Tube Broadcast Set—The "5-in-4" All-Wave Radio for A.C. Operation—An Easily-Built 3-Tube Midset Broadcast Superheterodyne Receiver.

THE SERVICEMEN'S SECTION

Bass Tone Control—Simplified Variable Selectivity—Practical Servicing Pointers—Servicing Universal A.C.-D.C. Receivers—Killing the "Intermittent" Bug—A Service Shop A.C. to D.C. Power Supply—Sideline Money for Servicemen—Adding A.V.C. to any Screen-Grid T.R.F. Receiver—Iron Particles in Speaker Air Gap.

TEST INSTRUMENTS

A Useful Nenn Lamp Tester—An Inexpensive Output Meter—Making Milliammeter Multipliers—Home-Made Frequency Modulator—The Busy Servicemen's V.T. Volt-Meter.

PUBLIC ADDRESS AND AMPLIFIERS

Build this Combination A.C.-D.C. Radio and Inter-Communicator—Speaker Placement in P.A. Work—The Design and Construction of an Inexpensive All-Push-Pull 10-Watt Amplifier—Obscure Sources of Hum in High-Gain Amplifiers—How to Build a High-Fidelity 5-Watt Versatile Amplifier.

"HAM" SECTION

Ultra-High Frequency Antennas—The Beginner's Low-Cost Xmitter—Modulator Meter—Phone Monitor—The Beginner's "Ham" Receiver—2½ Meter Acorn Transceiver.

TELEVISION

How to Build a 441 Line T.R.F. Television Receiver—Useful Notes on Television Antennas.

MISCELLANEOUS

Simple Photo-Cell Relay Set Up—Making a Burglar Alarm—How to Build A.C.-D.C. Capacity Relay—How to Make a Modern Radio Treasure Locator.

USEFUL KINKS, CIRCUITS AND WRINKLES

Making a Flexible Coupler—Two-Timing Chime—A Simple Portable Aerial—An Improved Non-Slip Screw-Driver. NOTE: The book contains numerous other useful Kinks, Circuits and Wrinkles, not listed here.

(approximately)

45 ARTICLES

(approximately)

170 ILLUSTRATIONS

68 BIG PAGES

**RADIO-CRAFT
20 VESEY STREET
NEW YORK, N. Y.**

RADIO-CRAFT

"RADIO'S GREATEST MAGAZINE"

. . . *Radio Broadcasting enters into a new stage of warfare*

RADIO BROADCAST WARFARE

By the Editor — HUGO GERNSBACK

In past editorials on radio warfare I have frequently commented upon offensive and defensive use made of radio in all of its various phases during war time. Indeed, it would seem that these uses are without end because new applications are found almost daily, much to the discomfiture of the warring nations affected.

As we have repeatedly reported, practically all of the nations at war are making use of various means whereby one country hopes to make the others' broadcasts unintelligible, if the need arises. The Germans even have a word for it, and they call these transmitters "*Stoersender*". Translated this word means "interference transmitter". When necessary, such transmitters go on the air with a specific wave length that coincides with the frequency which it is supposed to interfere with. Various noises are used, some of them sounding like a buzz saw, like a siren, others with a variety of shrieking sounds, all calculated to drown out the enemy broadcasts completely. Thus, if the Germans wish to drown out a Russian or English broadcast on a certain wave length sent into Germany,—in the German language of course,—one or more powerful Nazi *Stoersenders* go on the air, hoping thereby to prevent the German Nationals from listening to the foreign propaganda.

Naturally, the enemy countries know about this arrangement and try to circumvent it in various ways. As an additional precaution, the Nazis have passed laws many years ago prohibiting any German from listening to foreign broadcasts on the pain of imprisonment or even death. No doubt many Germans heed this command and do not listen in to forbidden broadcasts, but it is well known that there is still a large percentage of Germans who listen in anyway, whenever they have a reasonable chance of doing so without being caught.

Recently, however, to circumvent both Nazi laws and *Stoersenders* as well, the Russians have hit upon a simple and ingenious method which so far has proven devastating to the Nazis. The Soviet engineers installed a very powerful transmitter near Moscow, which we understand has certain directive qualities, so that the broadcasts will blanket Germany proper on their own wave lengths. In the Moscow station, a Russian news commentator,—who speaks fluent German,—sits in a studio in front of a microphone. Over his head is clamped a pair of ear phones. He is listening, let us say, to the Berlin transmitter on its usual wave length. While this is going on, the Russian transmitter is on the air also, tuned "dead-beat" to the German frequency, or wave length. The German news commentator now begins to give the latest German war report. When he pauses for a breath, the Russian commentator instantly starts speaking and in so doing heckles the German commentator. Thus, when the German news reporter states that 150 Russian planes have been shot down, instantly the Russian voice breaks in with a laugh and says "*Yes, but how many Nazi planes were shot down?*" There is no way out for the German listeners because they get both the German news commentator's reports as well as the Russian heckling talk, too. When this latest war comedy first started, the Berlin transmitter went off the air hurriedly, asking its listeners to tune in to Breslau. In the days that followed, the Germans tried to outwit the Russians by reading

so fast that there were no pauses. Nevertheless, the Russians managed to get in enough of their talk, which could not possibly escape the listeners. As this is written during the first days of September, the comic-opera broadcast-war between the two countries is still going on unabated. The unfortunate part for the Nazis seems to be that they never know when the Russians will break in on their broadcasts, because the Russians have it within their power to start talking any time they wish. They do not have to wait for a news broadcast but they can break in in any other pauses, during the interim of musical selections or other talks as well. It is out of the question for the Germans to run all of their broadcast selections together in such a manner that there would not be any pauses. Even if they could accomplish this, which seems doubtful, the Russians still could break in during "low modulation" periods. For instance, during certain passages when soft music is being played and other similar occasions. Furthermore, the Russians can also choose at will different wave lengths from different transmitters emanating from the Reich.

In all of this it will be seen that in this case, as in real warfare, the advantages are all with the offensive. As the Russians can choose whatever wave length they wish beforehand the best that the Germans can then do is to go off the air instantly and come on the air with their *Stoersender*. Then, the Russians can switch to another frequency and cause further disruption to the German broadcasts.

Humorous as all of this may sound from this side of the ocean, the Germans probably cannot see much humor in it, and if the condition keeps up, day in and day out, as it well may, then the Russians will certainly play havoc with German broadcasting for some time to come.

Nevertheless there are two sides to this, as is the case in all warfare. The Germans can retaliate and use the identical methods with Russia by playing havoc with their broadcasts as well. Here the Russians have one advantage, and that is, the distances in Russia are much vaster than those in Germany and it will be considerably more difficult for the Germans to blank out all of the Russian broadcasts.

Another point of importance in this broadcast warfare is that either side can go on the usual frequency when the station is not on the air. In Europe stations usually do not run as long or as late as in the United States, and while a German or Russian will know reasonably well whenever certain of his stations are on the air, it is possible that a certain percentage of the population may be listening in when, for instance, no German station is actually on the air. In that case, if the Russian station should start up, faking a German broadcast, the German listener would probably not be the wiser and, in this case, much mischief and propaganda can be effected. And, the German listener would not be breaking any law because as far as he is concerned, he was not listening in to any foreign broadcast. He therefore would be committing no crime, yet he actually would be receiving a foreign broadcast innocently.

These implications may be very far reaching and no one can say how far this sort of thing can be made to go. It proves, however, one thing: radio is and will be a most potent war weapon.

• THE RADIO MONTH IN REVIEW •

The "radio news" paper for busy radio men. An illustrated digest of the important happenings of the month in every branch of the radio field.



NEW GOULD F.M. ORGAN

Music is played on a glass top that is placed over a printed chart of keys. Music can be played faster than any other type of organ or piano for there is no time lag of keys or mechanical levers. Metal plates are placed beneath each key. The plates are fed with radio frequency current from a small R.F. oscillator which feeds through an engraved disc which has raised diamond-shaped portions in concentric circles, each circle producing a different note of the musical scale when the R.F. is absorbed by the body of the player.

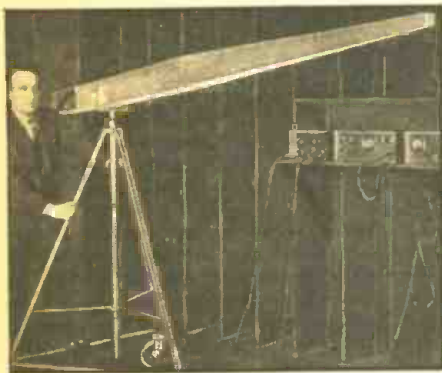

LONG SHOT MIKE

The latest "sound perspective" long-shot microphone designed in the RCA Laboratories. It is 10 feet long and because it is so sensitive and directional it is used "out front" approximating the location of the audience. Greatly enhancing the realism of radio, the movies and television it is presently being field-tested on the Hollywood lots.

F. M.

FREQUENCY MODULATION really has gone commercial, it seems, now that station W39B, Mount Washington, New Hampshire, has released the first advertising rate-card in the history of F.M. This Yankee Network station operates 16 hours daily, with 1 kw. (construction permit authorizes 5 kw.), on 43.9 megacycles, and counts in its coverage 5 cities in Maine, 6 in New Hampshire, and 2 in Vermont. For general musical or dramatic programs starting 6 P.M. the rate is \$50 per hour, \$10 for 5 minutes; earlier, the rate is halved. A 125-word announcement or 1-minute transcription is \$5 and \$2.50, after and before 6, respectively.

Station W43B, formerly W1XOJ, at Paxton, Mass. (near Worcester), has been authorized to use 50 kw., which makes it the biggest F.M. station in the U.S. to date.

An interesting semi-technical booklet, General Electric's No. GED-915, "How to Plan an FM Station," was released last month.

"A Profile of Frequency Modulation," booklet issued by FM Broadcasters, Inc., tells how Major Armstrong gambled his bankroll on Frequency Modulation—and WON!

New jobs for F.M.: (1) Last month Muzak Corp. received an OK from the F.C.C. to build a Frequency Modulation station to provide its high-fidelity transcription subscriber-type service to listeners; heretofore its service has been exclusively a wired-sound proposition for hotels, restaurants, and some home subscribers. (2) The Columbia Broadcasting System is planning to use three 50-watt F.M. relay transmitters for 2 circuits, to carry its shortwave programs from its New York City studios to its International Shortwave transmitter at Brentwood, L. I., about 40 miles away. One equipment will be used as a standby program circuit. (3) The Cleveland Railway Company's transit system has received F.C.C. OK to set up a 250-watt F.M. headquarters transmitter and 10 portable 25-watt 2-way car equipments, of G.E. make, for emergency use (reporting traffic complications caused by fires, etc.) by inspectors in cars "patrolling" the lines of the company.

BROADCASTING

NO one knows who "Bildad" is! (Read it backward, and invert it, and, if you drop a "d", you have *ad lib.*) He sends caustically critical cards to radio people—commentators, actors, announcers, singers. Practically every broadcaster has received one or more cards from this mystery amateur critic. Each of "Bildad's" cards winds up with the rubber-stamped warning: "BE VERY CAREFUL. BILDAD IS LISTENING."

N.B.C.'s Chief Engineer, O. B. Hanson, in announcing that 2 new audience-type studios are under construction at Radio City, points out that many artists cannot do their best work without a real flesh-and-blood audience. A total of 400 persons is adequate psychological stimulus for any such artist, says Hanson. No two wall surfaces will be parallel, a construction which eliminates echoes; vce'd ceilings dissipate reverberations from above.

Following are improvements which C.B.S. last month stated had been made, during the last fiscal year, from 5 to 44 stations in their net: power increases, new or improved transmitters, new transmitter sites, new or improved antennas, new ground systems and screens, new program-limiting amplifiers, new "feedback" (improved low-frequency response) amplifiers, new transmitter-checking facilities, new frequencies, and new day and night operation. So now you have an idea of how the networks improve technically from year to year.

Something new: "B.M.I. will pay the cost of operation" of a listening post, set up under the supervision of John G. Peatman, Director of the Office of Research, Dept. of Psychology, College of the City of New York, to supply a full daily report of all programs on stations WABC, WEA, WJZ, WOR, WMCA, WHN, WOV, and WNEW between 5 P.M. and 1 A.M. This department of C.C.N.Y. is to "act independently and not as an agent or representative" of Broadcast Music, Inc.

The dither resulting from the F.C.C.'s "Report on Chain Broadcasting" resulted in the publication of such pieces of literature as the following: "Mutual's White Paper" (Mutual Broadcasting System); "Why We Need a New Radio Law," and "What the New Radio Laws Mean," (Columbia Broadcasting System); and, "A Fair Deal for Radio" (a publication of The National Association of Broadcasters).

When "The Lone Ranger" died recently his place was taken by another—the originator of the program. But when Dr. Henry Lee Smith of the "Where Are You From?" program over WOR was called-up for service, as a Lieutenant in the Field Artillery Reserves, at Fort Bragg, North Carolina, the program went off the air, for his specialty could not be replaced effectively.

Title: "Radio Engineers While Away Odd Moments Telling Tall Stories." According to WMCA's press dept., engineers at the transmitter on the salt marshes at Kearney, N. J., complain that the Jersey skeeters this year carry straws to sip citronella. Frankly, we're inclined to doubt it. But then, we admit we've never been in Kearney during the mosquito season!

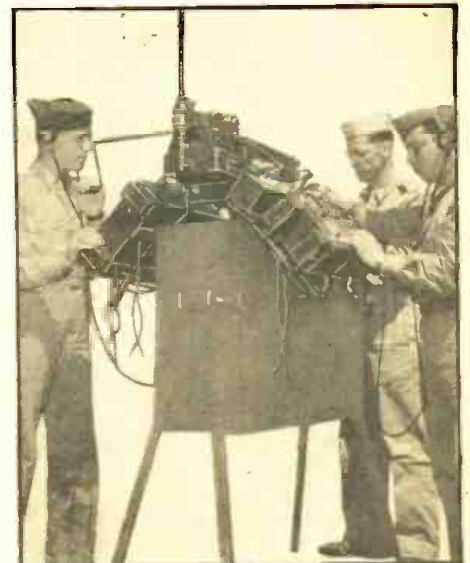

U. S. ARMY SIGNAL CORPS SCHOOL
Thousands of Uncle Sam's prospective Signal Men are undergoing intensive training at the Army Signal Corps School located at Fort Monmouth, N. J. Here students are shown familiarizing themselves with one of the many types of mobile units; this one designed for use on a pack animal. Notice the curvature of the equipment to fit the animal's back. It has a telescopic antenna.

In case you want to become a news broadcaster: it takes Rush Hughes, WMCA's 6 P.M. newscaster, 5 hours to prepare the 35 to 40 items he airs in 15 minutes!

The Columbia Broadcasting System plans to give birth to two 50 kw. International Shortwave stations, WCBX and WCRC, at Brentwood, Long Island, in September. Programs designed to interest Latin-American station affiliates of the network will be broadcast within their own listening areas, for the owners of the 4,000,000 radio sets below the United States border.

ONE of the newest applications of electronics is the polarograph, developed by Dr. Alois Langer of Westinghouse Electric & Manufacturing Company. It analyzes chemical solutions for the billionth ounce of substances, thereby solving problems of chemistry, biology and medicine in a matter of minutes which ordinarily assumes hours. This device, for chemical micro-analysis, operates on the principle of the electro-deposition of copper in a solution, the current from a storage battery being fed to the solution through a mercury contact. A solution that contains many substances may be analyzed by noting current readings for various voltages corresponding to the various chemical substances. The amount of copper deposited by these substances gives an indication of the amount of the substances.

UNUSUAL STATION WMCA SIGNOFF

ALTHOUGH it is several years since WMCA inaugurated its unique signoff message which contains a prayer for the oppressed peoples of other lands, the station is still receiving requests from listeners for copies of the dramatic conclusion to its day's activities.

The signoff, appropriately cast with sound effects and with a background of patriotic music, is heard nightly between 1:00 and 1:15 A.M. when the station goes off the air. The text of the signoff follows:

"This brings us to the close of another day. . . . From the heart of the theatrical district in New York City . . . from whence this voice comes . . . the bright lights are gradually fading.

"Night has cast its cloak over the roaring metropolis . . . bringing silence . . . peace . . . and welcome rest from work and the cares of the day. From early morn till late night we have had the privilege of bringing into your homes the colorful pageant of events . . . gleaned from all parts of the world . . . but all woven into a pattern to fit into the great tapestry of life.

"To the men aboard the many vessels ploughing the seas . . . we wish a safe journey. To our valiant air pilots we wish God-speed. To those who this night are separated from their homes and loved ones . . . to the sick and discouraged . . . may the dawning of the new day bring renewed hope and courage.

"At this time, may we express the fervent prayer that the sweet freedom of democracy so keenly enjoyed by all Americans may some day soon be restored to those people of all other lands who . . . tonight . . . are yoked by oppression. And may the spirit of brotherly love preserve inviolate the glorious principles on which our own great country was founded. Peace on earth . . . good will to all men!

"And now the voice of WMCA in New York City bids you all good night . . . good night . . . good night . . ."

THAT WAS RADIO . . .

WHEN writer-broadcaster Rush Hughes celebrated his 39th birthday, last month, he also celebrated the premiere day of his new commercial series "The World on Parade" on WOR at 10:55 p.m., E.D.S.T.

The first time Hughes visited WOR was back in 1928, when he came to the station for an audition. The program manager listened to him, told him he liked his work, but WOR had no openings at the moment. "You might try WABC," Hughes was advised.

Hughes took the advice, got a job there announcing. Six weeks later he was made Manager of Programs and Production. His sum total of experience in radio before getting the executive job had been 6 months of announcing remote band broadcasts on the Pacific Coast. That was radio . . .

The way Hughes got his California radio assignment before coming to New York was also typical of the rough-and-ready days of the broadcasting business. After a fling in the movies, Hughes landed a job running the entertainment in a San Francisco hotel. One day the announcer from KFRC didn't show up in time to handle a broadcast of Anson Weeks' orchestra from the hotel. Hughes stepped up to the microphone, announced the entire program ad lib, and immediately was offered a job at the San Francisco station.

Hughes recalls that he nearly got himself fired from one of his first radio jobs in the East in the 1920s when he improvised an inspired free commercial in hopes of enticing a prospective sponsor—a magazine—to the station. When he had to fill-in with a few minutes of ad lib during a broadcast, Hughes picked up a copy of a fiction magazine, and began reading part of a story—he promised to send the rest of the story on request. The magazine didn't fall for the stunt, and the station had to go to considerable expense in mailing the complete story to thousands of listeners who wanted to know how the plot turned out!

SOUND ANALYZER

The picture on the front cover shows the very latest development in sound analyzing. Such a device proves useful in the modern physics laboratory. Not only is it desirable and necessary to check the frequency of a sound wave, but also the particular shape of the wave is studied very carefully by the scientific investigator today. The apparatus shown is very flexible and sound waves of practically any frequency can be analyzed and studied with it.

Suggestion to Servicemen and dealers looking for an occasional electronic organ sale: The First Methodist Church in Wheeler, Tex., raised sufficient money in a few days to purchase a 2-manual Organtron by first giving a free organ recital in a local music store, and then canvassing the membership of the Church for possible subscribers to an Orgatron Fund.

It was good news for owners of RCA television receivers when the company announced, recently, that it would make all the adjustments necessary, to permit reception of the new (30-frame), 525-line transmissions that supersede the 441-line images, free of charge. The same news item pointed out that RCA plans to have a Washington, D.C., television transmitter operating about March 1, 1942, and a Philadelphia station about July 1, 1942, in addition to W2XBS atop the Empire State Building, New York City, now operating.



WAR-RADIO IN THE FIELD

The highly mechanized and highly specialized motorized warfare now taking place, would not be possible without the precise coordination of units which radio, as a means of communication, affords. As each week progresses radio stands out more clearly as one of the most important factors in modern warfare. These illustrations are official British photographs taken in the Western deserts. On top a radio operator is shown in his shallow desert pit communicating with other units. In the picture above a deep bomb-proof catacomb is being used by the Royal Signal Corps for carrying out their duties of keeping open communication lines. The catacomb is so deep that food must be lowered to them through a hole by means of ropes.

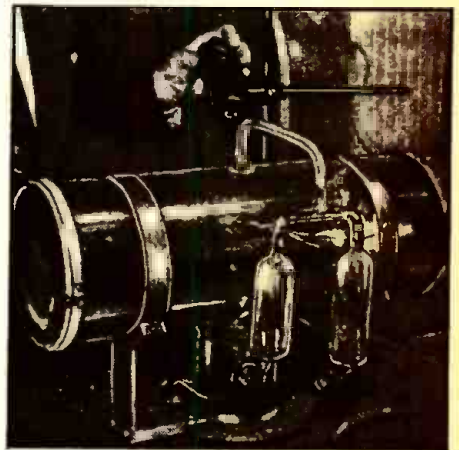

BREAD BOARD TUBE

Shown here is an ingenious device which saves considerable time in RCA Laboratories on light measurements being made on special photo surfaces. It is a demountable vacuum tube with a permanently attached exhaust pump. The pump is underneath the tube and enters the glass cylinder in the center. Two bulbs in the foreground are for measuring the vacuum.



At A, Captain John J. Martin (seated) of the New York City Police, assumes the role of a Civilian Defense Warden as he pushes a button, on a new RCA "Alert"-signal Transmitter unit in a Radio City studio of N.B.C., to release an inaudible impulse over WJZ to turn "on" an RCA "Alert"-signal Receiver installed at the Administration Building, LaGuardia Airport. At left is N.B.C. Special Events-man, Arthur Feldman.

At B, Mayor LaGuardia, participating as National Director of Civilian Defense, is shown with David Sarnoff (left), President of RCA, who demonstrates how the special signal generated by the device in photo A, automatically turns-on the receiver, and lights its lamp and rings its bell; special messages then issue from the loudspeaker (at end nearest the mayor). The device automatically shuts off upon receipt of an all-clear signal.

Presented here are the details of an "Alert"-signal Transmitter, and the new Receiver which automatically turns on upon receipt of this signal; delivers from a loudspeaker any special message broadcast by the transmitter; then, automatically turns off upon receipt of an "all-clear" impulse. Radiomen should familiarize themselves with this newest contribution to Civilian Defense.

COVER FEATURE

AIR-RAID "ALERT" ROBOT RADIO RECEIVER

WITH Mayor LaGuardia participating as National Director of Civilian Defense, the Radio Corporation of America last month demonstrated at LaGuardia Airport (Long Island, N. Y.) a new RCA "Alert" (emergency signal) Receiver that turns on automatically when it receives a special inaudible signal from a broadcasting station, rings a bell and turns on lights to summon listeners, and then shuts off when an all-clear signal is flashed.

"ONE IF BY LAND, TWO IF BY SEA . . ."

The Alert Receiver performs as a modern Paul Revere. In the initial demonstration, word that "enemy" planes had been sighted over Long Island was relayed from Army officers at Mitchel Field, to a Civilian Defense Officer in an N.B.C. studio at Radio City. Immediately, he pressed the button that sent the robot signal riding across WJZ's wave.

Within a few seconds the impulses turned on the Mayor's (RCA) Alert Receiver. The lights, green and red, glowed and the bell on the receiver rang to notify him that the N.B.C. Blue Network was ready from coast-to-coast to broadcast any message he might have as National Director of Civilian Defense. The device can be incorporated in standard broadcast receivers and television sets, to make them alert to the robot signal. In no way, however, does it interfere with the broadcast program on the air over the same station simultaneously.

The Alert Receiver is a simple instrument, about the size of a portable radio set, and can be carried just as conveniently.

This device was developed by Arthur F. Van Dyck, Stuart W. Seeley and Harmon B. Deal, engineers of RCA Laboratories. They describe it as a small, 3-tube receiver requiring negligible power for operation and, therefore, it can be operated 24 hours a day over a long period of time at low cost.

The receiver can be fixed-tuned to any one broadcasting station. It is then receptive to the inaudible signal from that transmitter. The Alert has a loudspeaker of its own, which normally is silent until the special electric flash is received. When the

signal arrives, it energizes an electric relay which clicks the loudspeaker into the circuit to reproduce the program from the broadcasting station. Simultaneously, the bell rings. If the Alert signal is flashed in the night, the bell, acting as an alarm clock, will awaken the listener.

The Alert Receiver can be designed to operate on alternating or direct current, or batteries. (Hence it's portable.)

The Alert Transmitter at the transmitting station is a simpler piece of apparatus. It consists merely of a vacuum-tube oscillator which generates the 2 sub-audible frequencies—one to turn on the Alert Receiver, while the other will turn it off. These frequencies may be 24 and 30 cycles a second (as employed in the demonstration).

The signal generating unit is connected to the broadcast transmitter like a microphone. In fact, the control room operator plugs the oscillator device and electric button into the microphone circuit. When the button is pressed it releases the "On" sub-audible signal, which turns on all receivers equipped to be actuated by it.

DEFENSE

Application of the Alert to Civilian Defense communication obviously is valuable, since it provides a local, regional or nationwide instantaneous radio call system without expensive new equipment. The engineers stress the fact that its use is automatically as flexible as the highly-developed transcontinental broadcast network systems, which permit the hook-up of 2 stations or hundreds by means of intricate switching arrangements already in service. Moreover, the Alert does not require even one additional frequency allocation for its full use. The instrument is so designed that it can be installed at a broadcasting station without disturbing a single wire used for normal broadcasting service.

Outlining the utility of the new device, it is pointed out that there has been set up by the Federal Government a Civilian Defense organization with Mayor LaGuardia as executive head. Local organizations will exist in every strategically important city

of the country. In New York City there will be nearly 200,000 Air-raid and Fire Wardens and others trained for civilian defense. They will be directed by hundreds of zone and district chiefs. The problem is to reach them all simultaneously and instantaneously. This, of course, would require considerable time by telephone, telegraph or by radio broadcasting since, up to now, there has been no way of suddenly calling all to listen. The Alert Receiver is designed to solve that problem.

In a similar way, should the President desire to deliver an unscheduled "fireside chat" to the Nation, he might summon a record-breaking audience by means of a signal flashed from the White House through broadcasting stations everywhere. As a result, the bells on "Alert Radios" throughout the country would ring.

Similarly, in television, the Alert can be made to notify set owners of an unscheduled event. Also, vast public service can be performed by the Alert Receivers in time of earthquakes, fires, floods and storms.

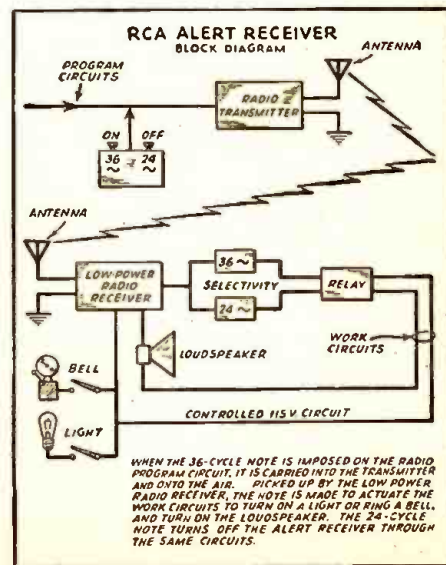

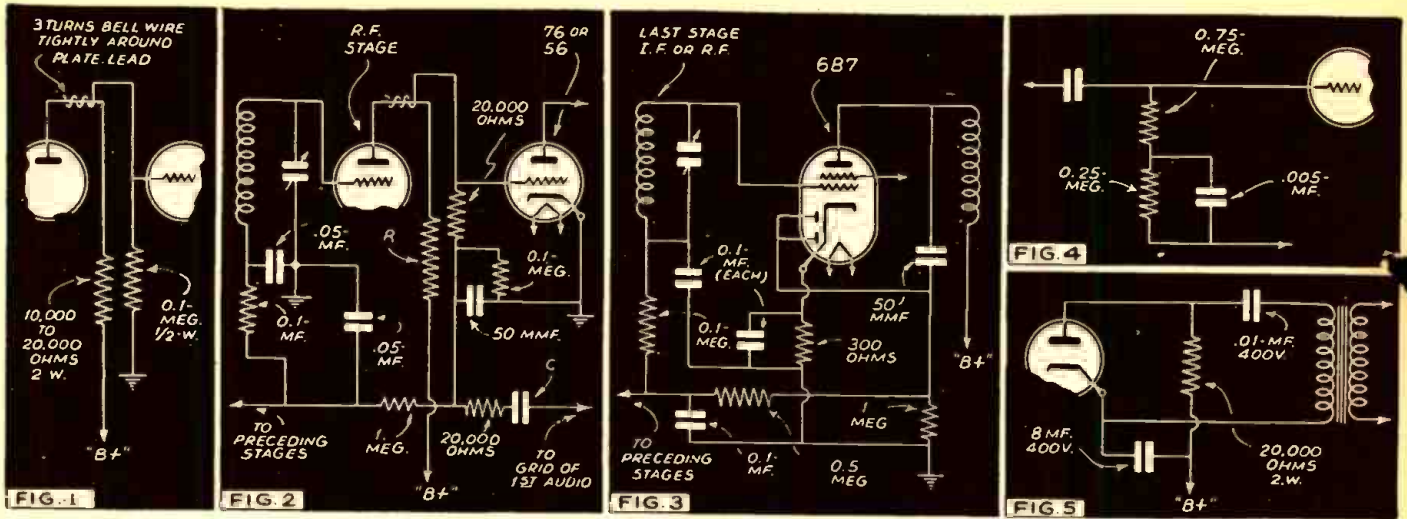

PUTTING "OOMPH" INTO RECEIVERS

This article is primarily intended for the man who builds his own and for the Serviceman who is called upon to improve old sets. If you or your customer have an old radio set, especially of the T.R.F. type, you can convert it into a modern "Hi-Fi" receiver by following the suggestions made below.

NATHAN GROSSMAN

OOMP" in radio reception is that added something which causes people to remark, "Now, there's a good radio." In technical terms it means that the set has above-average selectivity, or sensitivity. This may be accomplished very cheaply as no expensively designed circuits or parts are required.

In the ensuing discussion we will be more interested in results than in design, and because of this, some of the current pet notions of design will be questioned.

SENSITIVITY AND SELECTIVITY

To add sensitivity without affecting selectivity or tone quality, a stage of R.F. or I.F. may be inserted in the receiver by the use of a plate resistor and *gimmick* as an interstage coupling, as shown in Fig. 1. By means of this method of interstage coupling A.V.C. can be introduced into old T.R.F. receivers (see Fig. 2).

Added sensitivity and selectivity may be had by the use of one or more iron-core transformers in either the antenna, R.F., or I.F. circuits. Where iron-core transformers of the adjustable type are used and the receiver is in the same cabinet as the loudspeaker, the adjustment screw after being set should be held in place by the application cement. Otherwise the vibration of the speaker will cause the adjustment screw to vibrate and make the set noisy.

Another means of improving the selectivity and sensitivity is to replace the diode type of detector with a grid bias triode or pentode detector. Where such a change is made it would be advisable to substitute for the volume control in the audio circuit some form of manual sensitivity control. An improvement in the noise to signal ratio will result. This follows because most A.V.C.'s are only partially automatic and little can be done about noise reduction in the audio circuit without affecting tone. If A.V.C. is nevertheless desired, it may be obtained by using a 6B7 in the last R.F. or I.F. stage, in place of the tube ordinarily used there, as in the circuit shown in Fig. 3.

The problem of tone begins at the broadcasting studio and continues through every stage into the reproducer. If there is poor tone at the broadcasting end, it cannot be

remedied at the receiving end, that's certain!

Proceeding to the receiver, if the antenna is not of the right kind, the quality of reception may be affected. Thus if it is too short, considerable noise may be picked up. Moreover, side-band cutting may result because of increased selectivity of the antenna or interstage transformer. Low signal voltage increases the selectivity of the antenna transformer and effects a similar result in the other stages by decreasing the negative grid voltage in the R.F. or I.F. amplifiers.

Ordinarily a 25-ft. indoor aerial may be satisfactory. However, in one installation which the author made with such an aerial the tone quality was poor. By adding about 150 ft. of vertical lead-in, the tone quality was brought up to the standard for the particular receiver. Sideband cutting may also result from improper antenna because the operator of the receiver may "force" the set in adjusting his controls to get the proper volume level.

Likewise an improperly placed antenna may result in noisy or poor reception. One well-known manufacturer had an antenna control switch, apart from the wave band switch, marked "Local" and "Foreign." With the switch at "Local" the metropolitan high-powered stations came in with poor tone. In the "Foreign" position the tone quality was considerably improved. The length, position, and all controls of the antenna should be experimented with until the best all around results are obtained.

TONE QUALITY

The type and components of the R.F. amplifier influence tone quality. A band-pass T.R.F. receiver of the Miller type is the best for tone quality. For metropolitan districts a 2-stage T.R.F. receiver using 1 iron-core transformer will also be found suitable. The use of a 3rd tuning stage is to be avoided. The 3rd stage will not necessarily add to selectivity, but paradoxically, will probably unbalance the receiver and produce serious sideband cutting. However, the addition of an untuned stage such as suggested above and of iron-core transformers will produce the desired effect in regard to sensitivity, selectivity, and tone.

An I.F. amplifier designed for tone there-

fore should not consist of more than 2 I.F. transformers, which should be of the *band-expanding* type. A 3rd stage if desired should be of the *untuned* type suggested above, and should be inserted between the input and output stages. Such a third stage is used in General Electric model HJ-1205.

The audio circuit should have a bass boost below 150 cycles for several reasons: 1st, to compensate for the greater compression in this region in broadcasting and recording; 2nd, to compensate for any falling-off in this region which may take place elsewhere in the amplifier or in the speaker; and finally, to bring some of these tones within the threshold of hearing and thus create a better impression of tonal realism.

In regard to the last, it should be recalled that the difference between the threshold of hearing at 1,000 cycles and 100 cycles is over 40 decibels, and that therefore, in home reception unless these notes are emphasized by the amplifier, they may not be heard though actuated by the reproducer. *Bass compensation* should not be confused with *treble depression*. The latter will cause violins, saxophones, pianos, female voices, etc., to sound artificial and to lose realism. On the other hand, bass boost can be worked very satisfactorily with treble boost operating above 4,000 cycles and for similar reasons.

There are two principal ways of boosting bass. One is by putting a small condenser across the lower end of the grid resistor in a resistance-capacity coupled amplifier, as shown in Fig. 4. The other is to resonate the plate in a transformer-coupled circuit, as shown in Fig. 5.

The insertion of the resistance and condenser in the plate circuit in addition to resonating the plate will extend the bass response of the transformer by increasing the inductance in the primary of the transformer, which has been freed of D.C. Because of this many well-designed transformers found in older sets, or which had been put in the junk box, can be effectively utilized. The treble cut-off of the transformer, however, should not be below 7,500 cycles.

The output stage should be able to deliver a minimum of 3 watts for home reception

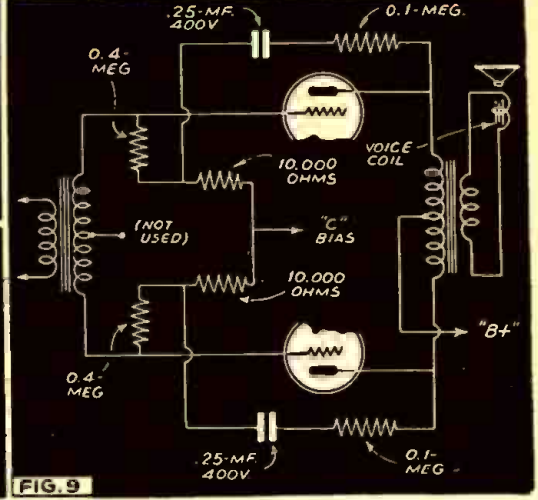
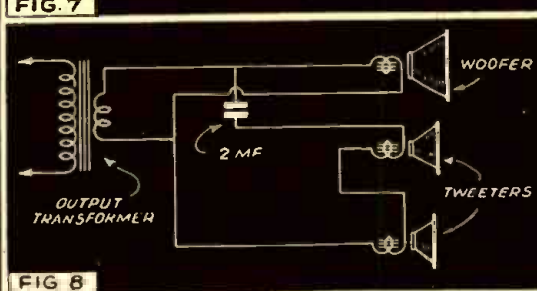
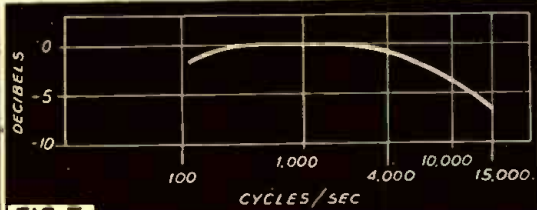
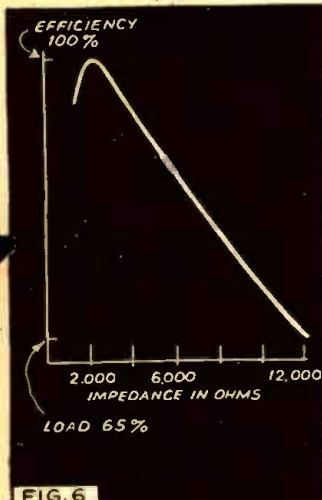

where the baffle length or height does not exceed 32 ins. or is not of the bass reflex type. Where the baffle is larger or is of the "bass reflex" type, the power handling capacity of the amplifier should be larger and bass boost should be used.

In a power tube a plate resistance of approximately 50,000 ohms works most satisfactorily. In a single tube output the use of a lower plate impedance and of an output transformer having a high primary impedance (to reach down into the bass), will cause the highs to suffer. This is because the efficiency of the low-impedance type of power tube falls off rapidly with the increase of the load impedance beyond the optimum point. How serious this is can be realized from the fact that at 50 cycles the load may be 3,000 ohms, but at 5,000 cycles the load for the same transformer is 300,000 ohms.

Figure 6 is a typical impedance efficiency curve for such tubes as types 71, 45, 50 and 2A3. Type 6L6 suffers somewhat from this defect because its plate resistance is about 25,000 ohms. It is not surprising, therefore, that an otherwise well-designed resistance-capacity coupled amplifier using a single 6L6 in the output should have a response curve which droops commencing at 4,000 ohms or even lower as in Fig. 7. This, however, does not hold true for the old-time amplifier with 2 stages of transformer coupling, or with transformer input in a push-pull output, as there is often present in such amplifiers sufficient regeneration of the "highs" to compensate for this defect. The 2A5, 6F6, 6K6, 41, 42, or 43 types, on the other hand, because of their excessively high plate impedance have too much 3rd-harmonics, and give a response which the ear quickly detects as artificial. Because of these reasons where 3 or 4 watts in a single tube output is desired, types 47, 59 as a class A pentode, and a 6V6, should be used. The author has had very good results with the 59-type as a class A pentode when used in conjunction with 10% inverse feedback. (This is contrary to prevailing practice, but try it, and you will be pleasantly surprised.)

If you have a good interstage transformer or a good push-pull input transformer which lacks a split secondary, either can be used in a push-pull circuit employing inverse feedback from the plate to the grid by connecting the two ends of the secondary to the push-pull grids and connecting the grids with feedback and "C"-bias circuits through matched resistances of the order of 400,000 ohms or higher in the circuit shown in Fig. 9.

CHOOSING OUTPUT TRANSFORMERS

There are current misconceptions regarding the basis for choosing output trans-

formers. The impedance of the output transformer bears a relationship to the power output, harmonic distortion and tonal response.

Most of the tube manufacturers in their data sheets state the impedance at which the various power tubes should be operated at the different voltages. These points are generally selected either for the lowest 2nd- or 3rd-harmonics or at the lowest point at which they intersect on the impedance response graph. The transformer has this optimum impedance at only one point of the sound spectrum, unless an impedance fixing device is used in the amplifier. Naturally, in a push-pull or inverse feedback amplifier in which 2nd-harmonics are nearly canceled out, the selection of a transformer impedance should not be based upon low 2nd-harmonics.

As to power output, the optimum point is generally selected at 400 cycles. But in such case what will the output be where you want it most, at 50 or 100 cycles? This may necessitate a primary 2 to 4 times larger than that selected for 400 cycles. The author has used output transformers with impedances 35-100% higher than specified by the tube manufacturer in a single-tube inverse feedback circuit with good results as to harmonic distortion and power output. For these reasons, use a husky transformer, even of the universal type, having a high impedance at 50 cycles at the current load under which you intend to operate it.

Where the source of the hum is an input stage, it is probably caused by an amplifier tube with the grid connection at the base of the tube, where it may be in an A.C. field. This can easily be cured by replacing such a tube with one of similar electrical characteristics but with the grid connection mounted on top of the tube, and by bringing a shielded grid lead above the chassis.

If the source of the hum is a transformer, the hum can be considerably reduced or eliminated by turning the transformer at right-angles to its original position, either horizontally or vertically, as the case may require.

Where the hum comes from the speaker field, the trouble may be solved by utilizing a P.M. speaker instead of one with a field coil, or by inserting a low-resistance, heavy-duty choke coil between the speaker field and the source of direct current.

LOUDSPEAKER

We now come to the reproducer itself. Let us leave out of the discussion the new bass reflex and the new coaxial tweeter-woofer speakers. The problem today is no longer how to get the low notes through, but rather how to get the highs through and to distribute them properly.

A simple and cheap solution, which can

be used on all speakers having a poor treble response or distribution, is to connect across the voice coil of the woofer, a 2-mf. condenser in series with the voice coils, in series, of one or two, 3-in., 4-in. or 5-in. P.M. speakers as in Fig. 8. This will work with such bad offenders as the arm-chair type of radio set. These tweeters can be placed in a separate housing and at such an angle or position as to afford wider or more direct-to-the-ear distribution of the treble frequencies.

If these ideas are used, you will be able to hear the wheezing of the saxs, the brassiness of the cornets, the rhythmic zoom of the bull fiddles, and speech which is astonishingly natural.

EXAMPLE

As an example of what can be done, the author took an 8-year-old T.R.F. radio set of average tone quality and converted it into a modern Hi-Fi receiver. The set consisted of 3 R.F. stages, a 27 grid-bias detector, 1 stage of resistance-capacity coupled audio frequency amplification, and a transformer-input push-pull output stage employing 45s. The set was located in a part of New York City in which a good part of its dial was blanketed by WOR. In addition, above 1,000 kc. selectivity was nigh impossible.

The transformation was accomplished by following the suggestions made above. The selectivity problem was solved by replacing the R.F. transformer in the 2nd stage with one of the iron-core adjustable type. To preserve treble, the 4th R.F. transformer was removed and a stage such as shown in Fig. 1 inserted. The bias detector was eliminated and the 27 was converted into a diode as shown in Fig. 2. A 57, connected as a triode, replaced the 27 in the 1st A.F. stage and its plate resonated. The substitution of tubes was made to get the higher mu and so compensate partially for the change in the means of detection.

The audio transformer of the push-pull stage was replaced by an old-time 3:1 ratio Samson "Symphonic" transformer. This transformer was well designed. Even without plate resonance it has a good bass response. It has a treble cutoff above 8,000 cycles and a peak at about 7,000 cycles. This transformer was used in a push-pull stage with inverse feedback in the manner shown in Fig. 9. In order to get higher amplification and more power, 59s as class A pentodes, were substituted for the 45s. The output transformer was not changed. A 3-in. and a 4-in. tweeter were added as shown in Fig. 8.

All parts and tubes cost less than \$10. But the set now performs and sounds like a \$100 job!

THE NEW IRC VOLUME CONTROL

MANUAL IS HERE!

(3rd Edition)



35% MORE LISTINGS—MORE ACCURATE—EASIER TO USE

- ★ The finest, most complete manual of its kind ever published. Unexcelled in its helpfulness to every serviceman who makes control replacements.
- ★ Lists correct controls for over one-third more radio receiver models than ever before.
- ★ Every replacement recommendation checked and double-checked against manufacturers' drawings, revised specifications or latest engineering data, etc.
- ★ Gives everything you need to know about a control *at a glance*—from manufacturers' original part number to Rider's Manual reference, price, switch data, etc.
- ★ Trade and brand names listed *alphabetically* so that you can find them quickly.
- ★ Auto radios listed the logical, easy-to-find way—by make of car.
- ★ New, large 8½" x 11" size with 136 pages and many new features including a handy information section, charts and formulas and complete IRC Control and Resistor catalogs.
- ★ The latest, most up-to-the-minute Manual of its kind on the market—now available through IRC Volume Control Jobbers.

Don't Miss It . . . Get Your Copy Today!

STANDARDIZE ON TYPE D CONTROLS ... IT PAYS!

Except for the necessary "specials", etc., this new IRC Manual is based entirely on the use of Type D Controls with Tap-in Shafts—IRC's famous small-size "Universal" Controls that have been breaking one sales record after another for more than two years. They are fully dependable—easier to install—more efficient. Tap-in Shafts frequently avoid the use of more costly "specials"—and a small, inexpensive control stock equips you for the big majority of all jobs.

"Streamline" your work by using Type D's.

18 Controls, 6 Switches, 5 Special Extra Shafts—to handle 60% to 75% of your control needs—all included in the attractive IRC Metal Cabinet for only \$14.97 net, \$24.95 list.

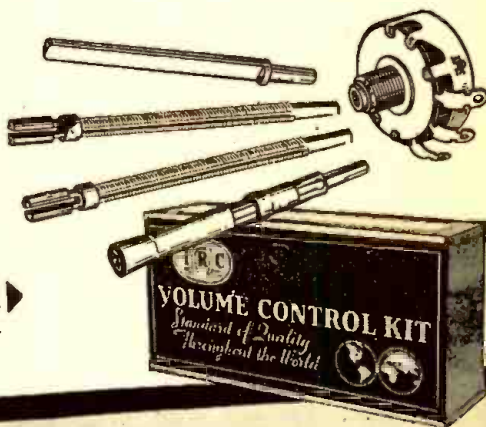

INTERNATIONAL RESISTANCE CO.

401 N. Broad Street • Philadelphia, Pa.

For Better Servicing - For Bigger Profits -

FOR A WIDER KNOWLEDGE OF TECHNICAL SUBJECTS, READ THE

BOOKS IN THE RADIO-CRAFT LIBRARY SERIES

GET into the swing of reading instructive, authoritative books on technical subjects—Radio, Air Conditioning and Refrigeration. The RADIO-CRAFT LIBRARY SERIES is the most complete set of volumes individually treating all important divisions in these fields. Each book has been written for the purpose of giving you the opportunity to specialize in one or more of the popular branches of the various subjects and we know of no easier, quicker or less expensive way to improve your knowledge. The material in each book is very helpful—you'll find them valuable in your work. The authors are all well known and are authorities on the subjects on which they have written. This is the first time that you are enabled to build a library of technical books by such popular writers.

ALL BOOKS ARE UNIFORM

The books in the RADIO-CRAFT LIBRARY SERIES are all uniform. The size is 6 x 9 inches. Each volume contains 64 pages and an average of 50 to 150 photographic illustrations and diagrams. The books are printed on an excellent grade of book paper and have stiff flexible covers. PRICE 50c PER BOOK. All books are sent postpaid.

 <p>Book No. 13 ABC OF AIR CONDITIONING An accurate simplified technical review of the fundamentals of this latest branch of engineering, including servicing data on present-day units. By Paul D. Harrigan. 50c</p>	 <p>Book No. 17 SERVICING WITH SET ANALYZERS A Study of the Theory and Proper Application of Modern Set Analyzers and Associated Apparatus. By H. G. McEntos. 50c</p>	 <p>Book No. 21 BREAKING INTO RADIO SERVICING Simple Instructions and Procedure for Starting a Profitable Radio Servicing Business of Your Own. By Robert Eichberg. 50c</p>
 <p>Book No. 14 POCKET RADIO GUIDE Edited by N. H. Loesem. Handy Reference Book for Radio Men—Set Construction Articles—Audio Amplifier Circuits—Useful Radio Formulas and Data—Handy Short-Cuts. 50c</p>	 <p>Book No. 15 ABC OF REFRIGERATION A carefully written volume, starting with the basic principles of refrigeration by mechanical means, and leading up to a complete analysis of the servicing of commercially available units. By Trafton Mason. 50c</p>	 <p>Book No. 18 POINT-TO-POINT RESISTANCE ANALYSIS For Service Men Theory—and Application of this Modern Test Procedure to Everyday Radio Service Problems. By Bertram M. Freed. 50c</p>
 <p>Book No. 16 PRACTICAL RADIO CIRCUITS A Comprehensive Guide to All Types of Radio Circuits For the Service Man, Constructor and Experimenter. By David Bollare. 50c</p>	 <p>Book No. 19 PRACTICAL RADIO KINKS AND SHORT CUTS The contents of this book have been planned with the view to help Radio Dealers, Servicemen, Experimenters and Set Builders. By B. Baker Bryant. 50c</p>	 <p>Book No. 22 NEW RADIO QUESTIONS AND ANSWERS Answers to Questions Most Frequently Asked by Both Novices and Experts. By Robert Eichberg. 50c</p>
 <p>Book No. 20 THE CATHODE-RAY OSCILLOSCOPE Theory and Function. Power Supplies and Associated Circuits, Sweep Circuits, Operation of Typical Unit, Methods of Measurement, Practical Applications of C-R Oscillographs. By Charles Sciaranza. 50c</p>	 <p>Book No. 23 PRACTICAL PUBLIC ADDRESS Modern Methods of Servicing and Installing Public Address Equipment. By B. Baker Bryant. 50c</p>	 <p>Book No. 24 AUTOMOBILE RADIO PRINCIPLES AND PRACTICE A Complete Treatise on the Subject Covering All Phases from Installing to Servicing and Maintenance. By B. Baker Bryant. 50c</p>

New titles are constantly being added to the RADIO-CRAFT LIBRARY SERIES. But, on the other hand, stocks of certain titles are running low, and they may not be reprinted for some time. We would therefore suggest that at this time you order as many different titles as you are interested in. Remember, that if you delay, some of the books may later be out of print.

USE THIS HANDY COUPON WHEN ORDERING

RADCRAFT PUBLICATIONS, Inc., 20 VESEY ST., NEW YORK, N. Y.
Gentlemen: Enclosed find my remittance of \$.....for which send me, POSTPAID, the Books indicated below.

RADIO-CRAFT LIBRARY SERIES @ 50c EACH
Circle book numbers wanted: 13 14 15 16 17 18 19 20 21 22 23 24

NameAddress

CityState

(Send remittance in form of check or money order; register your letter if you send cash or unused U. S. Postage Stamps.) RC-1041

RADCRAFT PUBLICATIONS, Inc.
20 VESEY STREET NEW YORK, N. Y.

SUBSTITUTE MATERIALS IN THE RECORDING INDUSTRY

FOR the past 3 months, as is well known, supply conditions have been quite upset in the recording industry. It has been impossible to see any distance into the future and no one has been able to give complete information as to the outlook. Now matters have been clarified somewhat and we wish to outline the present situation to users of blank recording discs.

ALUMINUM-BASE DISCS

We have definitely come to the conclusion that no new *aluminum* will be available for the manufacture of instantaneous records in any measurable future time. The industry has been given a B4 rating—which is a very good civilian rating—however, these ratings mean nothing so long as all aluminum is used in Defense industries.

The government is still permitting us to collect used discs. These are stripped and returned to the Aluminum Company of America for re-rolling. For these discs, as you know, certain companies promise to sell each customer new discs equal to the quantity of old discs returned.

The prices paid for used recording blanks are in line with scrap prices set by the government. Even if we were permitted by the Office of Production Management to pay more, a higher price would not be justified, since it would only mean that the price of new discs would have to be increased—and manufacturers are definitely trying to hold prices at present levels.

How long the government will permit us to continue this collection of discs we do not know. But until further notice disc manufacturers are accepting used discs on the above basis.

STEEL-BASE DISCS

Long before the aluminum shortage, experiments were made on a *steel-base* disc. At the first of this year, an acceptable steel was produced. Some of this material is now coming in and production is under way on 6, 8, 10 and 12 inch steel-base discs.

Due to the characteristics of the base material, steel discs cannot be manufactured to professional standards. Steel is already difficult to obtain and orders have to be placed far in advance. Thus in spite of the fact that adequate orders have been placed, we are not optimistic about future deliveries. Any day steel may also be placed on the priorities list and our supplies cut off.

GLASS-BASE DISCS

There is one base material, however, about which disc manufacturers are most optimistic in every way. The new *glass-base* discs are being widely acclaimed by the industry, and there is no present or future shortage of material to worry about.

To date, many thousands of these records have been shipped to all sections of the country and have received complete approval.

There are a few facts about the glass-base disc to which we wish to call your attention:

In the first place glass of 65-thousandths thickness was chosen after much experimental work. This thickness does not require any adjustment of present cutting equipment as used throughout the country. Tests also showed that discs made with this thickness could be readily shipped by freight, express or parcel post. It was also desirable to keep freight costs as low as possible and any thicker glass would only increase this item.

Differing Only in Size and Price!

WESTON
Pocket Size
TEST INSTRUMENTS

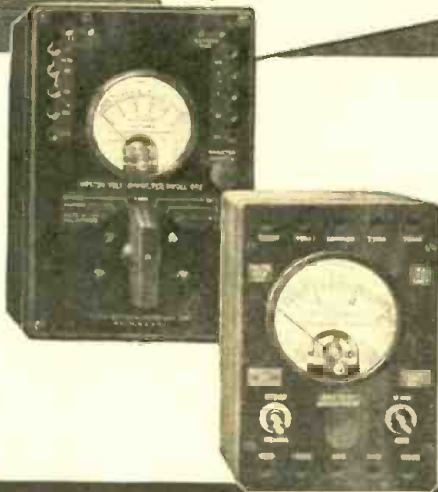

No need to sacrifice dependability when seeking the *convenience* which pocket-size instruments afford. For this series of WESTONS . . . while truly compact in size and low in initial cost . . . provide the dependability and long life which are typically WESTON. In addition, they are versatile instruments; Model 697, for example, providing the necessary voltage, current and resistance ranges for efficient trouble-shooting. Let us send you full particulars on these convenient, low-cost instruments. Write today.

WESTON ELECTRICAL INSTRUMENT CORPORATION
399 FRELINGHUYSEN AVENUE, NEWARK, NEW JERSEY

QUALITY PAYS . . . OR WHY MR. VAN DROOL DROPPED HIS SPOON IN THE SOUP

IT happened during the dinner hour at the Van Drool mansion.

Rich Mr. Van Drool was sipping soup in perfect rhythm to the music of his super de luxe radio console. Suddenly came a noise like a firecracker as a midget condenser—which serviceman Wilbert Fixit had installed just the day before—exploded. Mr. Van Drool jumped, dropped his spoon and swore. What made him so mad, he said afterwards, was not that he dropped his spoon in the soup, but that he burned his fingers getting it out.

That experience taught Serviceman Fixit a lesson. No more midget dry electrolytics for him. He'd use big, full-sized replacements and play safe. One day, however, his jobber gave Wilbert a sample Sprague Atom and some literature about it.

"Guaranteed not to explode!" snorted Wilbert as he read the literature. "Phooey!"

But Wilbert was a methodical man. He put the Atom under test. No matter what he did, it wouldn't explode. Although the condenser was only rated at 450 volts, he had to smack it with over 750 volts before it even broke down. Then Wilbert bought a dozen more Sprague Atoms and found they tested equally good.

While he was testing them, Mr. Van Drool's chauffeur dragged one of the

upstairs radios into the shop.

"The boss wants this fixed in an hour," he explained. "And no foolin'. He says it's your last chance to please him."

"Lordy," groaned Wilbert, after examining the set. "A three-section condenser gone bad. It'll take me a week to get one from the factory."

Then he thought of his Sprague Atoms and the ST mounting strap the jobber had supplied with them. He could take two 8 mfd. 350 V. Atoms and a 25 mfd. 25 V. Atom, strap 'em together—and the job would be done. It was the only thing Wilbert could do, so Wilbert did it.

To his surprise the three Atoms when strapped together were actually smaller than the original three-section condenser. Also, his total net cost on the Atoms was only 96c, whereas a duplicate unit would have cost \$1.20.

What's more, the Atoms stayed put.

Mr. Van Drool was more than pleased—and that meant Wilbert was pleased, too. Today he uses Atoms for practically all of his replacements, big or little.

"I save 'steen ways by using Atoms," is the way he puts it. "I save money, I save shoe leather, I save time, I save my good disposition—and I save customers. Best of all, Mr. Van Drool will never drop his spoon in the soup again."

Drooly yours,

SPRAGUE PRODUCTS CO.,
North Adams, Mass.

CONVENIENCE

the NEW Meissner

ANALYST



—has it!

The NEW Meissner ANALYST, with Direct Reading Electronic Voltmeter, is designed for the Modern Service Bench. Built for SPEEDY trouble-shooting, its carefully planned convenience will save EXTRA time . . . when time counts! You can get those RUSH jobs out in really short order—and know they're right!

Convenience is built into the ARRANGEMENT of controls on the new panel! Each Channel has its own separate section, plainly marked, and every control is right where you would expect to find it! No groping around the panel (or back of the cabinet) for a switch or jack connection . . . it's right there on the panel . . . where it belongs!

For that matter, ALL controls and jacks are ON THE PANEL! If you want to mount this instrument in your wall rack . . . that's your business . . . you won't have to turn the ANALYST around after it's plugged in!

Complete with tubes . . . ready to operate Model 9-1040 ANALYST, Net . . . \$96.25

SEE YOUR JOBBER—TODAY!



NEW INSTRUCTION MANUAL

F-M Data and valuable service information in addition to instructions on all Meissner Kits and equipment: 168 pages!

Only 50c Net

WRITE FOR FREE 48-PAGE CATALOG!

Dept. C-10



Another important question was whether it was necessary to have more than 1 hole in the disc. Careful study convinced us that 1 was sufficient. In this decision we were supported by leading recording engineers throughout the country. This decision was important since an additional hole might tend to weaken the disc and also might cause difficulties in manufacture which could prove detrimental to the quality of the final product.

Our new technique in cutting and drilling

glass now enables us to present a recording disc with all the excellent qualities of our best aluminum discs.

As to packaging—there is no difficulty. Standard packages in which these discs are shipped have been approved by shipping companies. Suitable boxes for shipping 1 to 3 discs are also available.

This article has been prepared from material supplied by courtesy of Audio Devices, Inc.

SERVICE HINTS

Suggestions on Audiodiscs.—This folder contains useful information for the sound-on-disc recordists. One facing page is headed "Helpful Suggestions for Cutting"; the other, "Helpful Suggestions for Playing-Back." Also of interest is the information on the back page for cutting glass-base record blanks. (Audio Devices, Inc., New York, N. Y.)

Carron 1941 Catalogue.—In addition to listing company's products, booklet includes exact-duplicate replacement coils for a long series of radio receivers of various makes. Also, this catalog contains the article "How to Properly Install a Replacement Cone," and lists exact replacements for a long list of home-radio and car-radio receiver with respect to their speaker cones. Another valuable section is entitled "Universal Field Coils" that contains technical information on replacement field coils and lists a large line of exact-duplicate field coils for a larger number of radio receivers of various makes. (Carron Manufacturing Co., Chicago, Ill.)

Amphenol Catalog No. 65—1942.—This catalog of all the Amphenol products also includes detail circuits showing the use in a circuit of certain of the items. (American Phenolic Corp., Chicago, Ill.)

Radio Interference Elimination for Public Utilities.—This 8-page booklet is a piece of technical literature which should be of interest to Servicemen who may have an opportunity to do any sort of service work in connection with interference traceable to the equipment of utilities. (Sprague Products Co., North Adams, Mass.)

Radio Chemicals and Products—Catalog No. 142.—This catalog of G.C. products includes an exceptionally extensive listing of dial-belts and replacement dial-belts for a large number of radio sets identified by make and model number. (General Cement Mfg. Co., Rockford, Ill.)

Stancor Service Guide and Replacement Transformer Catalogue, 7th Edition.—Extensive information on the selection of output and power transformers, filter chokes, input transformers, etc., in radio and P.A. service; includes listings for component replacements in approximately 5,000 radio set models of 73 different manufacturers conveniently listed by make and model number. (Standard Transformer Corp., Chicago, Ill.)

Stancor Packs for All Power Change Purposes.—In addition to cataloging various special packs for special purposes, as well as the Universal Replacement Power Transformer-Pack, it supplies curves and other performance data concerning such special power packs as those for farm-radio sets, line telephones, organs, time clocks, model railways, etc. (Standard Transformer Corp., Chicago, Ill.)

NEWS SHORTS

Allen B. Dumont Laboratories, Inc., last month announced an average 10% increase in the cost of its television receivers. The company has acquired additional factory space in which to build television sets. Its station W2XWV is helping augment the air fare for television receivers.

General Electric is upping the power of television station W2XB to 20 kw.

David S. Youngholm, vice-President of Westinghouse, recently announced plans to build a \$3,000,000 fluorescent lamp plant at Fairmont, W. Va.

BUT WHAT OF Tomorrow?

"All-out" production to meet today's pyramiding orders does not mean that Triplett has lost sight of the broader requirements of tomorrow. Instead, research and engineering programs actually have been "stepped-up" to assure constant improvements in products and processes; in addition to needed developments in new fields.

Today's demands are important, but the needs of tomorrow cannot be slighted—and are anticipated in never flagging engineering and research developments. You have assurance that in the months and years to come, new Triplett products will serve in expanded fields, where they will merit values and savings for every dollar spent in their purchase.

THE TRIPLETT ELECTRICAL INSTRUMENT CO.
Bluffton, Ohio

AN INVULNERABLE DEFENSE

can be achieved only through cultivation of the mind. Defend spiritual and ethical values, and become invincible, under the banner of righteousness, now being unfurled by a New Race and Order. Send for our latest 60 page, illustrated brochure, LEMURIA THE INCOMPARABLE. It reveals who you are, why you are here, your past history and your future inheritance. TWO DIMES covers the cost of mailing. Act today. You incur no obligation of any kind.

LEMURIAN FELLOWSHIP DEPT. 57, 928 N. PLANKINTON AVE., MILWAUKEE, WISCONSIN

PATENTS—TRADE MARKS

Booklet concerning Inventions & Patents Form "Evidence of Conception" with instructions for use and "Schedule of Government and Attorneys Fees"—Free

LANCASTER, ALLWINE & ROMMEL
Registered Patent Attorneys
436 Bowen Bldg. Washington, D. C.



Now as Always..
**YOU CAN DEPEND ON "ALLIED"
 FOR EVERYTHING IN RADIO
 AT LOWEST PRICES!**

**Free
 RADIO'S
 GREATEST
 CATALOG**

**212 PAGES!
 BIGGEST
 EVER!**

FOR SERVICEMEN · DEALERS · SOUND MEN · AMATEURS · BUILDERS

Today, more than ever, ALLIED is the one name that means Everything in Radio. Today, more than ever, you can always depend on ALLIED for vast, complete stocks of the leading makes of diversified equipment in every field of radio and electronics. You can always depend on ALLIED for quality merchandise that's "tops," for rush-service direct to you on all orders, for those extra values you'll not find equalled anywhere in radio today. There's never been so complete, so value-packed a catalog as the new 1942 ALLIED book—the FREE 212-page Catalog you'll need to keep up with radio. Servicemen, Dealers, Amateurs, Sound Men, Experimenters—send for your copy of Radio's Greatest Catalog that shows the lowest prices in the entire field.

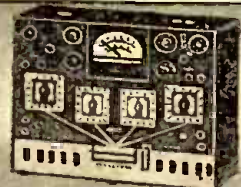

50 NEW SET MODELS
 You'll want to see the 1942 KNIGHT "Radio Hit" models—more than 50 of them—featuring the newest styling, latest developments, low prices that can't be challenged. There's a radio for every room—New FM-AM models; luxurious Phono-Radio Period models; new-style plastics; Table Models; portables, recorder-radios; farm sets; auto radios—radios for every purse and purpose!

KNIGHT SETS PA PACE
 There's a big new section devoted 100% to PA. New Systems—7 to 60 watts; new biased-power amplifiers; new-type "Bantam" Portable Systems. Everything in microphone, speaker and phono accessories; valuable data and charts on how to select the right sound system. Get the facts about our 15 Day Trial Offer and the Easiest Time Payment Plan in PA!

BIG SERVICE SECTION
 The most complete catalog in all radio's history—nothing like it ever before. Page after page of the very latest quality Test Equipment—all the leading makes—all the newest gadgets, tools, books, to make service work easier, faster, and far more profitable. And more than 50 pages devoted exclusively to replacement parts for repairing any radio. It's the Serviceman's Buying Guide!

BOOK HAMS LIKE BEST
 And there's a reason, because the 1942 ALLIED Catalog is packed with the most complete Amateur listings in our long history. All the new communications receivers; new x-mitter kits; tubes; keys; accessories; replacement parts; specialized electronics equipment—everything in radio for the amateur is combined in one exclusive section. Ask about our liberal Amateur time-payment plan.



BUILDERS' GUIDE
 Nothing like it for the Builder and Experimenter has been published before. After page of new build-your-own kits; the popular "DX-ers" in new versions; new FM kits; "Popular Mechanics" Kits; dozens of new diagrams, circuits; everything for the Radio Builder and Experimenter! We'll supply FREE parts lists for any circuit described in magazine construction articles. You'll want this great 1942 Catalog—send for it now!

MORE THAN 15,000 PARTS
 Today, more than ever, you can count on ALLIED'S vast stocks for everything you need in radio. Our experienced staff of merchandising specialists have spent months in combing the market to maintain and build up the most complete stock in radio's history. All the famous makes are offered; complete listings in every field are available—and all at lowest prices. Don't miss the big special Bargain Section that sets new value records!



FLUORESCENT LIGHTING
 For those extra profits, and extra savings, see our completely new Fluorescent Lighting rotogravure section. Here's a wide variety of low priced easy-to-install new fixtures and accessories for commercial, industrial and home lighting applications—at new low prices that will amaze you. It will pay you large dividends to investigate this profitable new field! Clip the coupon below for the most reliable fluorescent guide to complete stocks.

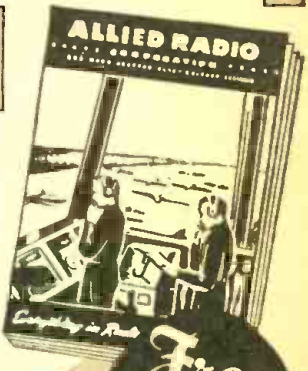

**Free
 SEND
 COUPON**

ALLIED RADIO CORP.
 833 W. Jackson Blvd., Dept. 2-K-1
 CHICAGO, ILL.

Rush me a copy of your FREE 212 page Complete Radio Catalog for 1942.

Name

Address

City State

ALLIED RADIO
 833 W. JACKSON BLVD. · CHICAGO

DETROLA A.C./D.C. MODEL 3271 SERIES

7-Tube Superhet.; 2 Bands (540 to 1,720 kc. and 5.55 to 18.5 mc.) A.C./D.C. Operation; Automatic Volume Control; Push-pull Beam Power Output; Built-in Antenna for Broadcast Band; Iron-Core 1st I.F.

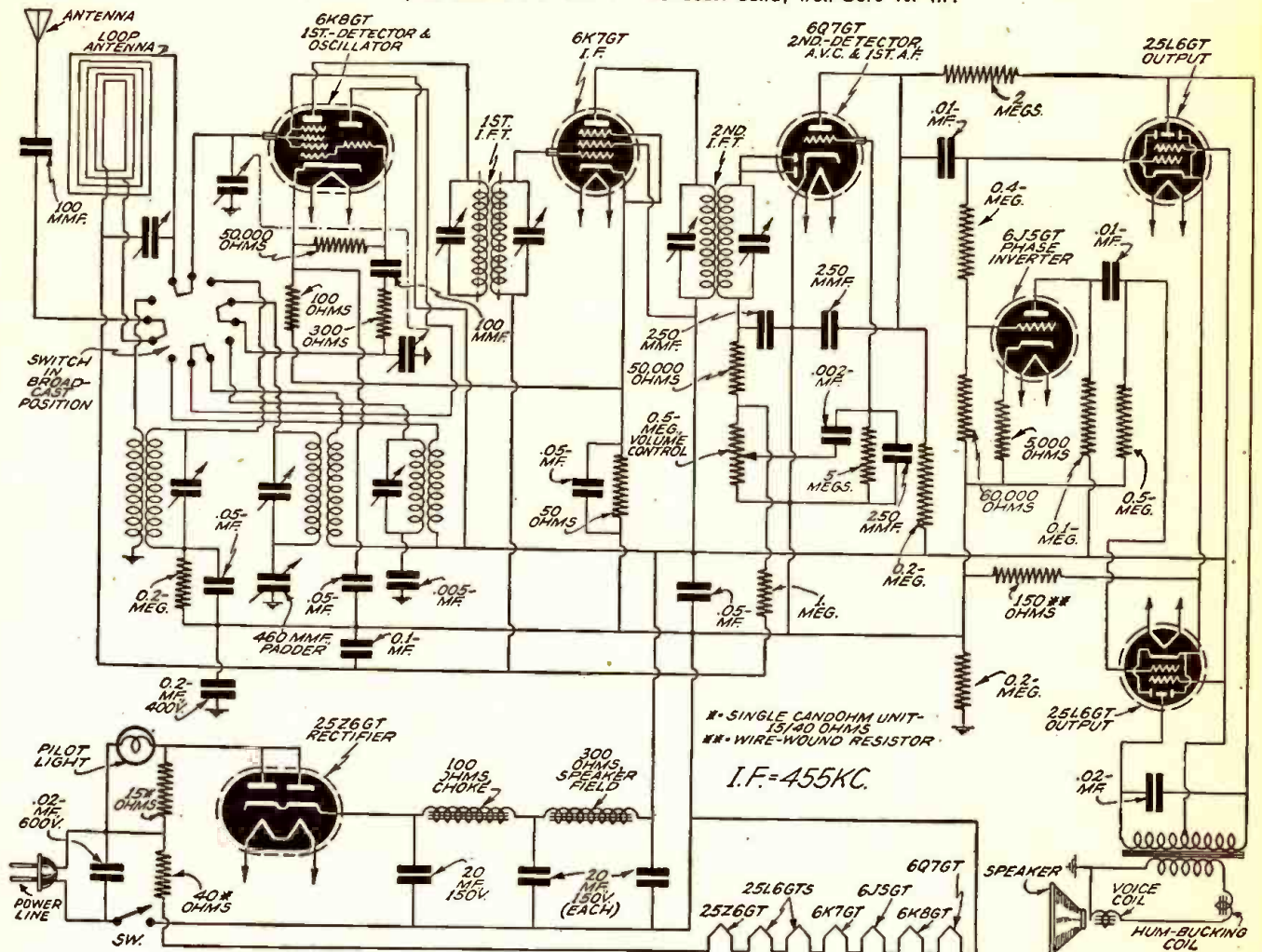

Schematic diagram of the Detrola 3271 series.

ALIGNMENT PROCEDURE

Turn the band switch to the Broadcast position. Connect an output meter across the speaker voice coil. The volume control should be set a few degrees from the maximum volume position. Use a weak signal from the generator; strong signals tend to cause improper adjustments.

I.F. Alignment: Connect the signal generator ground to the receiver chassis through a 0.1-mf. condenser. Using a 0.1-mf. condenser in series with the "high" side of the generator, apply a 455 kc. signal to the control-grid of the 6K7GT tube and align the 2nd I.F. transformer. Connect to the control-grid of the 6K8 tube and align the 1st I.F. transformer. (See Chassis Layout Diagram for location of these adjustments.) From this position rereck both transformers again.

Broadcast Band Alignment: Turn the band switch to the Broadcast position, turn the tuning condenser all the way to the right (minimum capacity), apply a 1,720 kc. signal to the control-grid of the 6K8 tube and adjust the broadcast oscillator trimmer. The oscillator coil is under the right hand end of the chassis and this trimmer is the one nearest the front of the chassis. To align the loop antenna, connect a single-turn loop across the terminals of the generator, place the receiver about 1 ft. in front of the single-turn loop, set the generator at about 1,400 kc., tune-in the signal and adjust the trimmer on the loop antenna assembly for maximum response.

Shortwave Alignment: Using a 400-ohm resistor between the high side of the generator and the antenna terminal (on the LOOP frame), turn the tuning condenser to minimum capacity, set the generator at 18,500 kc., and adjust the shortwave oscillator trimmer. This trimmer is immediately in back of the broadcast oscillator trimmer. Set the generator at about 17,000 kc., tune-in the signal and adjust the shortwave antenna trimmer for maximum response. This trimmer is mounted on the loop antenna.

NOTE: If considerable hum appears when the generator is connected as described above use smaller condensers between the generator and the receiver. The best way is to use a 1:1 transformer to isolate either the receiver or the generator from the line. The adjustments of this receiver are very stable and no aligning should be attempted unless absolutely necessary.

Detrola Table Model 3271, 7-tube, 2-band superhet. receiver. Caution: Use no ground.

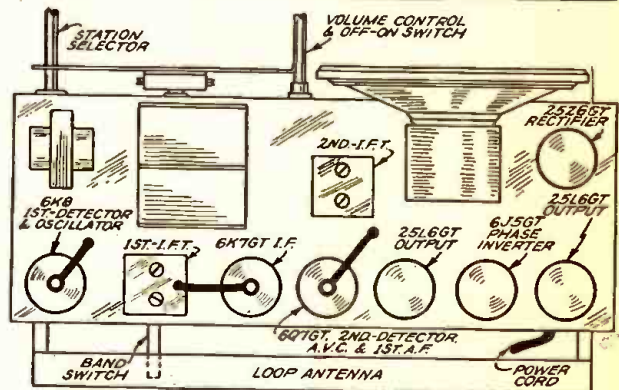

Chassis layout diagram showing locations of parts.

•SERVICING•



Readrite
MODEL 432-A

The Outstanding Tube Tester Value
Checks all type tubes including Loctals, Bantam Jr., 1.4 volt Miniatures, Gaseous Rectifier, Ballast, High Voltage Series, etc. Filament Voltages from 1.1 to 110 volts. Direct Reading GOOD-BAD Meter Scale. Professional-appearing case with accessory compartment large enough for carrying Model 739 AC-DC Pocket Volt-Ohm-Milliammeter, thereby giving the serviceman complete testing facilities for calls in the field. . . . Model 432-A with compartment, Dealer Net Price \$20.73. Model 432-A in case less compartment \$19.65. Model 739, Dealer Net Price \$10.89.

WRITE FOR CATALOG—Section 1016 College Drive

READRITE METER WORKS, Bluffton, Ohio

Most - Often - Needed RADIO DIAGRAMS and Servicing Information

4 OUT OF 5 CIRCUITS YOU NEED

In these easy-to-use complete manuals you have all the diagrams you really need. Over 80% of the sets you service every day are included. Use these important, hint-giving, trouble-shooting circuits to make your job easier. You must be satisfied, or your money back is guaranteed.

NEW 1941 VOLUME

Let this latest manual give you all 1941 circuits you will ever need. Introduce you to new radio developments, help you to do better servicing. Includes clear schematics, alignment data, service hints, I.F. peaks, and parts lists. Compiled by M. N. Belmont, radio serviceman, author, teacher. 192 pages, 8 1/2 x 11 inches. Net only **\$1.50**

1940 DIAGRAM MANUAL

Covers all popular models of 43 manufacturers for this important radio year. Data on P.M., 3-way portables, intercoms, recording. Service hints, alignment suggestions. 417 models. 208 pages. **\$1.50**

MOST-POPULAR 1939 SCHEMATICS

Another condensed manual of most-popular diagrams you need. Circuit data, hints, and information are time-savers and money-makers for you. Let these diagram manuals guide you to easier and faster service work. Diagrams of 39 manufacturers. 192 pages, 8 1/2 x 11 inches. **\$1.50**

1926-1938 MOST-SERVICED DIAGRAMS

The most popular manual of the series. Will pay for itself with time saved the first day of use. 427 diagrams of most-serviced radios needing service every day. With parts lists and alignment information. 244 N. Belmont, radio serviceman, author, teacher. 192 pages, 8 1/2 x 11 inches. **\$1.95**

SEND COUPON OR SEE YOUR JOBBER

SUPREME PUBLICATIONS, 3727 W. 13th St., Chicago, Ill.

Ship the following manuals
under money back guarantee terms. I am enclosing \$ in full payment. Ship postpaid.

NAME: RC-O-D
(Write address below and send this corner.)

CHART INDICATING TELEVISION TUBE FAILURES

Tube and Function	Picture	Sound	Miscellaneous
1852 Modulator	Raster, no picture Picture		Tube is microphonic, gray bars appear when cabinet is tapped, or when loud audio signals are heard
6J5 Oscillator	Distorted picture No picture	No sound	
1852	No picture	Sound OK	
1st Video I.F. 1852	No picture	Sound OK	
2nd Video I.F. 6H6	No picture	Sound OK	
Video Detector and Clipper 6V6G	Picture** No picture	Sound OK	
Video Output 1852	Picture**	Sound OK	
Sync Separator 6N7	Insufficient height		
Vertical Oscillator	Out of frame		Picture syncs slightly down from top or up from bottom. Picture may appear as merely a horizontal line.
6F8G Vertical Deflection Amp.	Insufficient height		
6N7 Horizontal Oscillator	Insufficient width		Picture may appear as a vertical line.
6F8G Horizontal Deflection Amp.	Insufficient width		Picture may appear as a vertical line.
879 or 2Y2 High Voltage Rectifier	No picture	Sound OK	Centering controls have no effect
5V4G Low Voltage Rectifier	No picture	No sound	
1805—P4 Picture Tube	Momentary Spot		Momentary picture, screen blooms, picture disappears. Yellow spot: burn, due to operation at excessive brightness.
	Dull		Dull picture due to long use of picture tube.
	Odd Size		Note: If faulty picture size can not be corrected by size or hold controls, look for open connection from cable to picture tube socket.
1852 Sound I.F.	Picture OK	No sound	
6SQ7 Detector and 1st Audio	Picture OK Picture OK Picture OK	Microphonic howl No sound Distortion	
6V6G Audio Output	Picture OK Picture OK	Noise in speaker No sound Weak, distorted	

*This individual Chart applies to Andrea Radio Corp. teleceiver models, but the idea may be applied to other teleceivers to suit.

**Sync. slipping.

Other Failures—If, after checking the tubes, reception of pictures or sound is not satisfactory, go through the Sight and Sound Chart.

(Continued on facing page)

RADIO DEFENSE

Following is the text of a letter-carbon received by *Radio-Craft* last month; presumably, the original was sent to Mayor LaGuardia.

Radio-Craft has long held the opinion that there is a great deal to be done toward setting-up facilities for maintaining radio transmitter and receiver operation under emergency conditions which might interrupt the regular source of power. The floods and storms, which seemed to be especially prevalent last year, brought this situation forcibly to the attention of many radio broadcasters, etc. What do *Radio-Craft* readers have to say in comment, on Mr. Slifer's especially timely suggestion?

The Honorable F. H. LaGuardia,
Mayor of the City of New York,
New York, N. Y.

Sir:
Our country is dotted with amateur

radio "hams" who have excellent receivers and transmitters also, these operators are generally intelligent and of good character. In an emergency these well scattered amateur radio stations could maintain communication with all sections of the country even when all telegraph and telephone systems were disrupted; however, since this amateur equipment is powered with "line" current they too would be blacked out unless they had a second standby source of power available . . . such powerplants are to be had and in the writer's opinion should be made available to the better stations located in strategic spots. Also, all Army units should be complimented with a list of such stations, which would insure a countrywide communication system even after all "line" power failed.

Very respectfully yours,
W. J. SLIFER,
Easton, Pa.

(Continued from opposite page.)

SIGHT AND SOUND CHART

SYMPTOM	REMEDY
Picture will not hold vertical sync	Adjust vertical hold control. Do this with contrast control as low as possible. Insufficient Signal: Antenna must be oriented, moved to more favorable location, or raised in height. Ratio of signal to noise may be too low. Increase height of antenna. If lead is over 100 ft. long, coaxial cable may be required. Note: May be due to losses introduced by antenna leads to other television receivers. Remove such leads. Interference: Ratio of signal to noise may be too low. See Insufficient Signal notes above.
Picture tears	Adjust horizontal hold control. Interference: Ignition interference may cause tearing in all or part of the picture area. See Insufficient Signal notes above.
Picture shows horizontal distortion	Adjust horizontal hold control.
Picture is broken by angular pattern	Interference: See Insufficient Signal notes above.
Picture has white retrace lines	Interference: See Insufficient Signal notes above.
Picture is distorted by sound	Brightness control too high, contrast control too low. Insufficient signal: If contrast control is at maximum see Insufficient Signal notes above. Transmitter adjustment is not correct.
Pictures without sound	Adjust trimmers A and E for minimum signal at 14.25 mc.
Pictures and sound weak	Adjust trimmers B, C, and D for maximum audio output at 8.25 mc., and check adjustment of Sound Sensitivity trimmer at the side of the chassis. As a last resort, after you have checked everything else, realign R.F. plunger condensers.

MARINE USE OF RADIO

THE Communications Act contains specific provision with respect to the employment of radio for the promotion of safety of life and property at sea, and the duty of enforcing the radio provisions of the International Convention for the Safety of Life at Sea adds to the Federal Communications Commission's responsibility in this field.

There are 2 general types of marine radio services: ship radio-telegraphy, using telegraph code signals; and ship telephony, permitting voice conversation. The large ships which are required by law to provide radio facilities are equipped with radio-telegraph equipment. However, the smaller vessels which are not required by law to be radio-equipped find it more convenient to employ radiotelephony to communicate with other ships and the coastal harbor stations on land.

Licenses to operate ship radio stations are issued by the Commission. At the present time there are more than 4,300 outstanding ship licenses. Approximately one-half of this number are issued to ship telephone stations. Twenty coastal harbor stations have been licensed to communicate with ship telephone stations; four others are under construction.

During the past 3 years the number of ship radiotelephone licenses has increased more than 300%. Ship and shore telephone radio frequencies are now active with transmissions to and from vessels navigating the Great Lakes, the coastal waters, and the inland waters of the United States.

The specific frequencies 2,738, 35,860, and 37,660 kilocycles are assigned to ship telephone stations for communicating primarily with other ship telephone stations. That of 2,738 kilocycles is the one most widely used at the present time. The ship-to-shore frequencies are governed by the respective frequencies of the individual coastal harbor stations. Various frequencies throughout the spectrum are assigned to ship radiotelegraph communication, the frequencies 3,115, 3,120, 35,860 and 37,660 being used primarily for contact with other ship radiotelegraph stations.

The privilege of operating a radio transmitting station aboard United States ships

is limited to citizens. Heavy penalties are provided by law for the operation of a ship radio station by unlicensed personnel.

In the past the owners of small craft had been reluctant to use radio-telegraphy, since a knowledge of the International Morse Code is required for this type of communication. With the advent of radiotelephony these vessel owners have been able to equip their boats with such service and act as operators themselves without acquiring a working knowledge of the telegraph code. However, a person who holds an amateur operator license only is not permitted to operate any class of ship station. Under certain conditions, the holder of a restricted radiotelephone operator permit may operate a ship radiotelephone station. Adjustment of apparatus can be made only by a licensed operator holding at least a 2nd-Class Radiotelephone Operator License.

The Commission maintains special marine safety radio watches at Baltimore, Md., and Portland, Ore. These stations are manned on a 24-hour basis by trained experts equipped with special marine receivers, auto-alarms, and frequency measuring apparatus. Here observations and frequency measurements are made regularly on all classes of ship radio stations. A ship station may have its frequency thus measured many times a year, yet no report is made to the licensee unless an off-frequency condition is found to exist.

Under the law, all radio stations are required to give absolute priority to radio communications or signals relating to ships in distress, must not cause interference to such calls, and must assist distressed vessels as far as possible.

Detailed information about ship radio service may be found in the following 3 publications obtainable from the Superintendent of Documents, Government Printing Office, Washington, D. C., at the prices indicated: "Rules Governing Ship Service" (Part 8), 10c; "Rules Governing Commercial Radio Operators" (Part 13), and "Study Guide and Reference Material for Commercial Radio Operator License Examinations", 15c.

SAVE

YOU TIME and MONEY!

RCP TEST INSTRUMENTS
MODERN, ADVANCED, LOW-COST

Get This
Signal
Generator
Only \$25.95

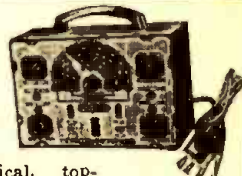

Most economical, top-quality oscillator on the market today! Only instrument of its kind that offers all the latest improvements in circuit and mechanical design at this low price. Extremely wide all-wave coverage continuously variable from 95 kc. to 100 mc. Accurately calibrated direct reading. Output modulated or unmodulated at will. Effective accurate attenuation. Highly attractive appearance. Everything, in fact, that a fine signal generator ought to be, except costly. You need such an instrument now—get it today! A.C. operated.

FOR ALL TUBES!

DYNOPTIMUM

Test Circuit

Special \$17.95



Tests new miniature and Bantam, Jr., tubes and all other new and old receiving tubes as well as all ballast tubes. Provides for tubes up to full line voltage. Tests at RMA specified plate voltages and loads. Hot interelement short and leakage test between all individual elements. Hot cathode leakage test. Noise test—indicates noisy tubes that would otherwise test "good." Spare socket for future tubes with new base arrangements. Adjustable for all line voltages 105-135 with line voltage indication directly on meter. Direct reading. Counter model, complete.

See your RCP distributor at once or write



RADIO CITY

PRODUCTS COMPANY, INC.

88 PARK PLACE • NEW YORK, N. Y.

EVERYTHING IN RADIO



This big book serves your entire needs. It includes sets, parts and supplies, public address, amateur equipment, test-ers, kits, fluorescent lighting. Nationally known favorites at lowest possible prices. Write today for your copy of this

BIG FREE CATALOG

BURSTEIN-APPLEBEE COMPANY

1012-14 MCGEE STREET, KANSAS CITY, MISSOURI

OPERATING NOTES

Because the Notes printed below are exceptionally good, submitted by a top-notch Service Engineer of recognized repute, this month's entire "Operating Notes" department has been devoted to them.

BERTRAM M. FREED

Trouble in . . .

... CROSLEY 148

A common complaint, in this and others of this general type of Crosley receiver, was a low-frequency hum at the lower end of the dial. The only necessary repair is a complete alignment after which it has been found helpful to melt a little wax onto the hexed nuts of the trimmers to prevent them from coming loose when the set is accidentally jarred.

JOHN ANTUL,
Saxonville, Mass.

... CROSLEY C-597-B

Intermittent and noisy. Replace the 0.006-mf. bypass condenser from plate of 25A6 to 30-mf. electrolytic condenser. Replace with standard-make 1,000-volt condenser. This also applies to many other Crosley models, as the A-266, etc.

... RCA 14BT-1—14BT-2—14BK

Regeneration, whistles, noisy reception. The grounding finger for the shield of the 1N5GT may be corroded at the contact of the base pin, No. 1 pin on the tube socket, which grounds to the chassis. Use a hot iron on the contact, even though it may look like a good connection.

... WESTINGHOUSE 209

Inoperative. Obvious conclusion on preliminary analysis—dead output transformer. Upon complete circuit analysis, the 1,900-ohm speaker field coil frequently is found open. The field coil on these sets is also used as a choke for the filter condenser systems. See part No. SA-107358 (Gernsback), "Official Radio Service Manual," Vol. 7, pg. 732.

... ZENITH 5805

Whistles and distortion. Shrill whistles upon turning the volume control, and distortion of electric eye tube, is nearly always caused by a shorted 16-mf. electrolytic condenser.

... NOTE TO SERVICEMEN NEW TO THE GAME

All often-serviced radio sets.—When repairing receivers that have been "repaired"—or I should say made to work—by someone who is a handyman on a farm or factory somewhere, and has read a book on radio service, check for wires in unsuspected places that have been cut and just wound together without the benefit of a tight-soldered connection. This one little bungling job will cause you plenty of headaches if you aren't on the lookout for it. I know, as I was a victim of a screwdriver and pliers man.

EDWARD J. WELLS,
Wells Radio Service,
Pennsgrove, N. J.

... PHILCO 54

Fading can usually be traced to the coupling condenser opening. This should be replaced with a Philco part, as the block con-

SERVICEMEN—

What faults have you encountered in late-model radio sets? Note that *Radio-Craft* will consider your Operating Notes (they need not be illustrated) provided they relate to **CHARACTERISTIC (repeatedly encountered) faults** of a given set model. Payment is made after publication of the Operating Notes.

tains a small, essential mica condenser as well as an old-value coupling condenser.

... RCA-140

A raspy and noisy sound is often due to a defective output transformer. The 53 in the output of this set delivers quite a bit of power and the manufacturer's part seems inadequate. Mount a heavy, replacement output transformer on the loudspeaker instead of on the chassis.

... RCA K-80

The oscillator coil for the broadcast band is grounded to the mounting foot of the coil. This lead breaks off, causing the set to go "dead." It can be repaired quite easily by removing the coil and resoldering.

... ZENITH A.C./D.C. MODELS

Speaker field burns out. A number of 1940 Zenith sets using a 25Z6 as a voltage doubler, and equipped with a 600-ohm speaker, were rewired by Zenith to A.C./D.C. The speaker is connected from "B+" to ground and after a couple of months burns-up. The remedy is to either replace the speaker with one of proper field resistance, or to use same type of speaker and connect 750-ohm, 20-watt resistor in series with it to ground.

... RCA-78 WITH NOISE SUPPRESSOR

This set goes dead and will only play if the type 55 tube is removed from its socket. The fault lies in the 3rd I.F. transformer. When no signal is applied to the 55's grid, the tube draws the maximum amount of current. The cathodes of the types 58 and 55 tubes are common. Therefore, if no signal is applied to the 55, the I.F. tube is biased to cutoff. A defective 3rd I.F. will give the same effect even when signal is present. If a replacement cannot be secured, the suppressor-grid circuit may be eliminated.

... PHILCO PT-26

Low-frequency oscillation in this set may be traced to a defective I.F. transformer. When replacing, dress the I.F. leads or the set will not align.

ROBERT KANE,
Central Radio,
New York, N. Y.

... PHILCO 818K CAR RADIO

Intermittent reception. This trouble has been traced to the Local-Distance switch mounted on the control head. Replace the switch, or if not needed, ground the open

end of the 500-ohm resistor located in the set. This resistor is tied to the cathode of the type 78-I.F. tube.

... PHILCO 41-285

A rumbling noise emanating from speaker, and more noticeable when walking across the floor or when jarring the set, sometimes may be traced to the 1st I.F. transformer. Resolder both ends of the small mica condenser located in the shield with the I.F. transformer.

... PHILCO 608-P, 625-P, 629-P, 623-P, 609-P, 610-P, 611-P, 616-P

Complaint: (1) reproduction of recordings is flat, no noticeable bass, and no volume. All these models are equipped with photoelectric reproducers. Adjust the light beam control padder for best tone, volume and brilliance of light-beam in the tone arm. The padder is located on top of the chassis, near the tuning condenser.

Complaint: (2) phonograph reproduction is "fuzzy" and "jittery." Adjust the position of the lightbeam on the photoelectric cell. The beam should be vertical, with half of the light on the cell and the other half on the border of the cell. The adjustment is located on the side of the pickup. If the above does not cure the ailment, replace the mirror assembly.

... PHILCO 39-117, 118, 119, 39-6, 7, 39-30, 35, 36, 39-17, 19, 25

(1) The bias resistor, in the high-voltage center-tap to ground, sometimes burns-up. To affect a repair, dismantle the power transformer and replace all leads with a better-insulated type, or use a good grade of spaghetti over the present leads. The original leads are rubber-covered and are of the type that after being in use for a while are inclined to dry up and shed their rubber insulation, this in turn leaves a bare spot which naturally shorts to the case of the power transformer.

... PHILCO 37-640

Complaint: no volume; stations weak. Replace the 0.05-mf. A.V.C. bypass condenser in the R.F. stage.

... MIDWEST 12-TUBE TABLE MODEL (No model number)

Complaint: drifts. Replace the 25-mmf. mica condenser across the 600-kc. padder with "silver mica" type of the same capacity.

... WURLITZER 316, 416, 616, 716 & 616A

Excessive bias on the type 45 output tubes. Replace 5,000 ohm 10 watt resistor running from center tap of driver transformer to ground with one of like value. If no bias is available check resistors running from plate of bias rectifier 45 to center tap of driver transformer. No. 1 resistor tied to plate of bias rectifier tube type 45 is 2,000 ohms, 10 watt and No. 2 resistor tied to No. 1 resistor is likewise 2,000 ohms, 10 watts. Check bias rectifier tube.

(Additional Operating Notes on Page 217)

OPERATING NOTES

.... PHILCO C-1808, C-1708 CAR RADIOS

Intermittent reception. Replace R.F. coupling condenser. This condenser is part of the R.F. coil assembly part No. 65-0421.

WALTER FERNALD,
Service Manager,
Flack's Appliance Shop,
Brady, Texas.

.... PHILCO 620 CODE NO. 121

This set oscillates at high level of the volume control and works perfectly right below normal setting. The trouble is an open filter condenser from B plus to ground common to the plates of the R.F. tubes.

.... PHILCO 800 CODE NO. 122 AUTO RADIO

Noisy or erratic operation of this model is traced to a faulty tapped volume control with switch. Replace the entire unit with standard replacements.

Also distortion and intermittent signal output in this set is caused by an open-circuiting defective coupling condenser to the grid of the 75 tube. Where the signal is still distorted and weak, change the high frequency by-pass condenser at the diode return.

.... EMERSON BL210

Set dead. The trouble was an insulation break-down of the high voltage secondary layers of the Power Transformer short-circuiting several of its layers, causing the output voltage to swing below the average. Rewind or replace the whole unit.

Identical complaint on some equivalent models is traced from one section of a filter block in a tubular form shorted. This is a dual unit Part No. 3RC318A.

E. AZPA,
15 Mango Road,
Sn. Francisco, Quezon City,
Philippines

.... RCA U-40

The pushbutton tuning mechanism of this model may be found difficult to operate or fail to function completely. This condition in many cases may be caused by the entire chassis dropping down from its original position in the cabinet.

To correct this, simply loosen all three mounting screws holding the chassis in place so that the entire chassis can be pushed up again as far as possible and held in position until the three mounting screws are retightened so the chassis will not slip down.

.... CADILLAC C-8 AUTO RADIO

When one or more of the pushbuttons stick or fail to return to their normal position when an adjacent pushbutton is depressed, remove entire unit of seven push-buttons from dash and inspect slots on each side of individual catalin pushbuttons to ascertain if any of the small polished ball bearings are missing from these slots or "ball races." Before replacing missing bearings rub a light film of machine oil in slots and on sides of pushbuttons.

When unit has been replaced on dash all pushbuttons will then operate freely.

.... SILVERTONE 6120

When reception is weak and distorted, much time will be saved by first tracing blue lead between first I.F. coil and plate of mixer tube. This lead may be found jammed between underside of chassis and corner of bracket supporting pushbutton assembly, causing insulation on wire to be cut through there by grounding plate circuit.

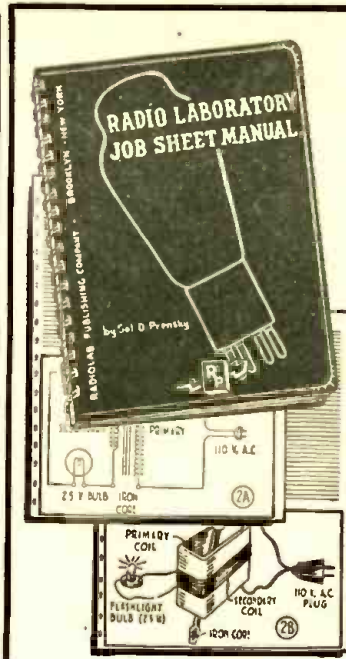

LEARN BY DOING!

A NEW BASIC COURSE OF
INSTRUCTION ON PRACTICAL WORK

RADIO LABORATORY JOB SHEETS MANUAL

by Sol D. Prenskey

"Written for practical instruction from the dual vantage points of teacher and technician." (Review Section of RADIO-CRAFT)

The manual contains 24 practical radio projects arranged to explain and illustrate the fundamentals of radio, with definite layout instructions. It consists of about 80 pages, wire bound, with over 100 illustrations. It is especially adapted for school laboratory work of a basic course in Practical Radio. An educational discount of 20% on orders of six or more. List Price \$1.80

Copies Available to Instructors for 10-Day Approval

FREE! Write for Circular RLJ, and obtain a complimentary copy of a comprehensive RADIO SYMBOL CHART, including the Continental Code, and Resistor and Condenser Color Codes.

SEND 10c IN COIN for deposit, if you wish a copy of the manual sent to you C.O.D. You pay the balance, plus a small Post Office collection charge.

RADIOLAB PUBLISHING CO., 652 Montgomery St., Brooklyn, N.Y.

.... PHILCO 37-116 CODES 121-122

When magnetic tuning is found inoperative, and the rest of the set checks OK, check mixer tube to be certain it is a 6L7G and not a 6J7G or 6N7G as the writer has found on several occasions.

Magnetic tuning will not function unless the proper pentagrid mixer amplifier tube is used.

.... DODGE-PHILCO 1940 AUTO RADIOS

Manual tuning inoperative. Pushbutton tuning OK. Due to flexible shaft breaking at tuning knob end fitting because original flexible shaft was cut too short causing an abrupt angle at knob fitting.

To overcome this trouble cut replacement shaft approximately 1/4" longer than original shaft. This will allow more play in shaft when it is rotated.

.... BUICK 980535

Intermittent reception when installed in car, but when removed to bench tests and operates OK.

As this model uses dual speakers, inspect leads from external speaker to five prong speaker plug for defective soldered connections. Resoldered connection usually eliminates this trouble.

Because the voice coils of both speakers are connected in parallel to tap on output transformer through a common lead, an open circuit in this lead will cause both speakers to become inoperative simultaneously.

.... BUICK 980526

When the complaint is very weak reception of both distant and local stations, considerable time will be saved by checking the resistance of the volume control, which invariably increases in value as much as 5 megs.

Replace with a reliable 1 meg. tapped control which will not be readily affected by the extreme temperatures associated with most auto installations.

F. J. PROSSER,
10203 Parkview Ave.,
Garfield Heights,
Cleveland, Ohio.

SAVE UP TO 50% FACTORY-TO-YOU

FREE "RED HEAD" BOOSTER AERIAL

WITH THIS CHASSIS (For Limited Time Only)



9 BANDS (ON 6 DIAL SCALES)

20 TIMES EASIER FOREIGN
TUNING with SUPER
BAND SPREAD RADIO!

PUT THIS
CHASSIS IN YOUR
PRESENT
CABINET

UP TO \$50.00
TO \$19.75
TRADE-IN

with SPEAKER,
TUBES, PUSH-
BUTTON TUNING,
MAGNA TENNA
LOOP AERIAL—
READY TO PLAY

THINK OF IT... 20 TIMES EASIER TO TUNE... 10 TIMES MORE SENSITIVE THAN ORDINARY RADIOS! Crystal Clear High Fidelity Tone, Famous 30-day trial plan fully protects you and enables you to prove Midwest's powerful new 1942 Super Spread Band performance in your own home, without obligation, as thousands of people every day are doing. Write today. Your name on a 1¢ postal card will do.

WRITE FOR BIG FREE
1942 CATALOG
SHOWING RADIOS,
RADIO PHONES,
HOME RECORDERS
FROM \$12.95 to \$112.50
UP TO 16 TUBES

9 BAND
CONSOLE
\$43.95
COMPLETE

30
DAYS
TRIAL

E-Z TERMS
USER AGENTS WANTED

MIDWEST RADIO CORPORATION
DEPT. 12-E CINCINNATI, OHIO



FREE! RADOLEK'S BIG RADIO PROFIT GUIDE

Everything New in Radio at Bargain Prices! Radio parts—Sets—Accessories—Ham gear—Electric appliances and supplies—Public Address Systems. Don't Wait—Send for the Big FREE Radolek Profit Guide Now! Save Money at Radolek.

RADOLEK CO., Dept. C-59
601 W. Randolph St., Chicago, Ill.

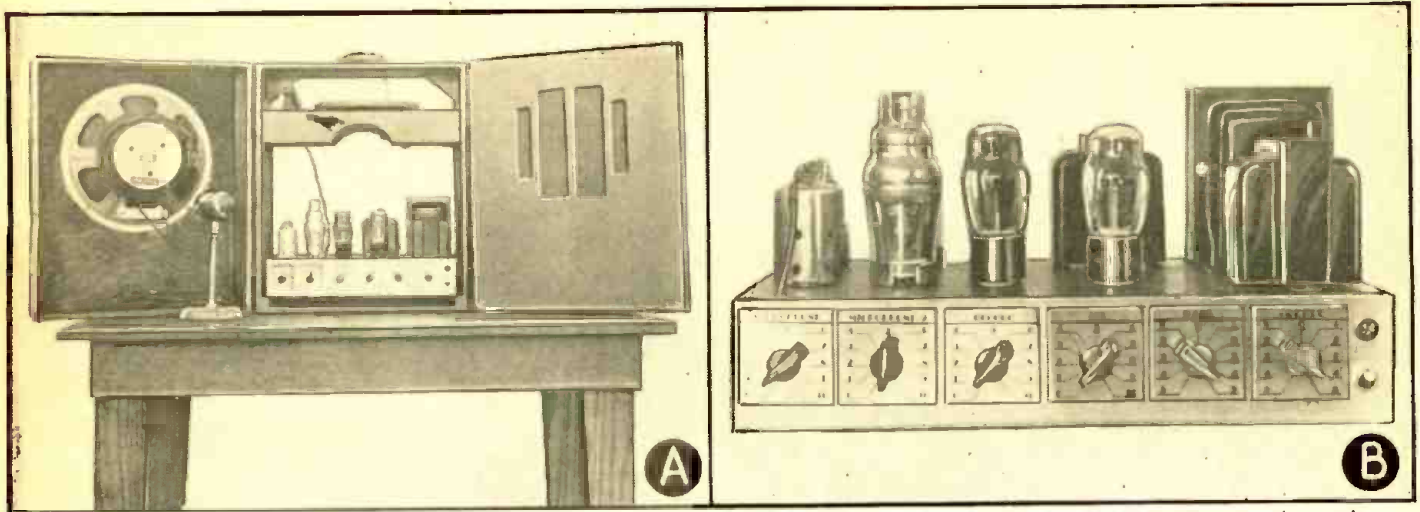

A.—The front appearance to Mr. Prewitt's completed Channel Analyzer. B.—A looking-down view showing the top-of-chassis parts placement.

A SIMPLIFIED CHANNEL ANALYZER

The following article presents the details of a Channel Analyzer of simplified design that results in quicker service work and lowered construction cost. These all add up to a piece of test apparatus many Servicemen will be glad to add to their complement of test equipment.

D. H. PREWITT

THE writer has for some time felt the need of some form of a Channel Analyzer in diagnosing receiver troubles, particularly those troubles where noisy or intermittent conditions were present in the set. Also one of these instruments is a convenient means of determining the quality and quantity of signal at a particular point.

WHY STAGE GAIN

One thing not felt necessary however was the determining of the exact gain of different R.F. stages by measuring the exact R.F. voltages present at different points. This measurement of stage gain is all right for the set designer but for the Serviceman it is practically unnecessary and can waste a lot of time.

If an R.F. stage is properly tuned and shows a reasonable amount of gain to the ear it is practically always doing its job in a satisfactory manner. Even if it were off a little it would be hard to tell it because the service notes on most sets do not give stage gain. The absence of this feature also simplified the construction and reduced the cost of the Analyzer here described, and so it was left off until a greater need for it was felt.

In view of the limited functions desired and also the price of commercial models it was decided to dig down in the junk box and see what could be put together. An audio amplifier complete with power supply was already built, so the I.F. and R.F. channels were built right on the chassis of the audio amplifier. Of course, additions like this do not make for symmetrical panel assemblies, but it works and is inexpensive, so the goal was achieved.

The most important things to find are the coils. The junkbox will usually produce a couple of good-quality broadcast-band coils but the I.F. coils are harder to find.

It was found that by taking a Miller No. X727RF coil and shorting-out the pie winding furthest from the primary that the coil would cover the required band of 170 to 475 kc. It is easy to short-out this pie because the 3 pies are well separated so that the wire can be easily fished out and cut. Care must be exercised to sand the enamel off the Litz. wire without breaking any of

the small, individual wires making up the whole. The R.F. coils used (see List of Parts) have good gain and a flat response. These coils covered a band of 500 to 1,500 kc.

The tuning condenser is a standard broadcast type. A 3-gang condenser was used because it was desired to do a little experimenting with 2 and 3 tuned stages. An extra tube socket will be seen that goes with the extra tuning condenser. The tuning condenser is mounted on rubber by putting rubber grommets through the chassis mounting holes, then fastening spade bolts with washers on each end through these grommets. The tuning condenser is fastened to the spade bolts with self-tapping screws. The dial is mounted on the tuning condenser and is free to move with it. This rubber mounting may not be necessary but it is

easily arranged and certainly doesn't hurt anything.

The gang switch composed of sections Sw. 2, Sw. 3, Sw. 4 and Sw. 5 was salvaged from an old Midwest receiver. It has plenty of extra points on it so that shortwave coils can be added if desirable. Sw. 6 is a jack switch and is operated when the audio lead is plugged into the jack. Condenser C2 is used as an additional attenuator to aid R3.

TEST LEADS

The test leads are made out of crystal microphone cable using the tips and handles of an old pair of test leads. These handles are made out of hollow fiber about 4 ins. long. The condenser, C1, is contained inside the hollow tip of the R.F. lead. This condenser is made as follows.

The R.F. Lead.—First a piece of hollow

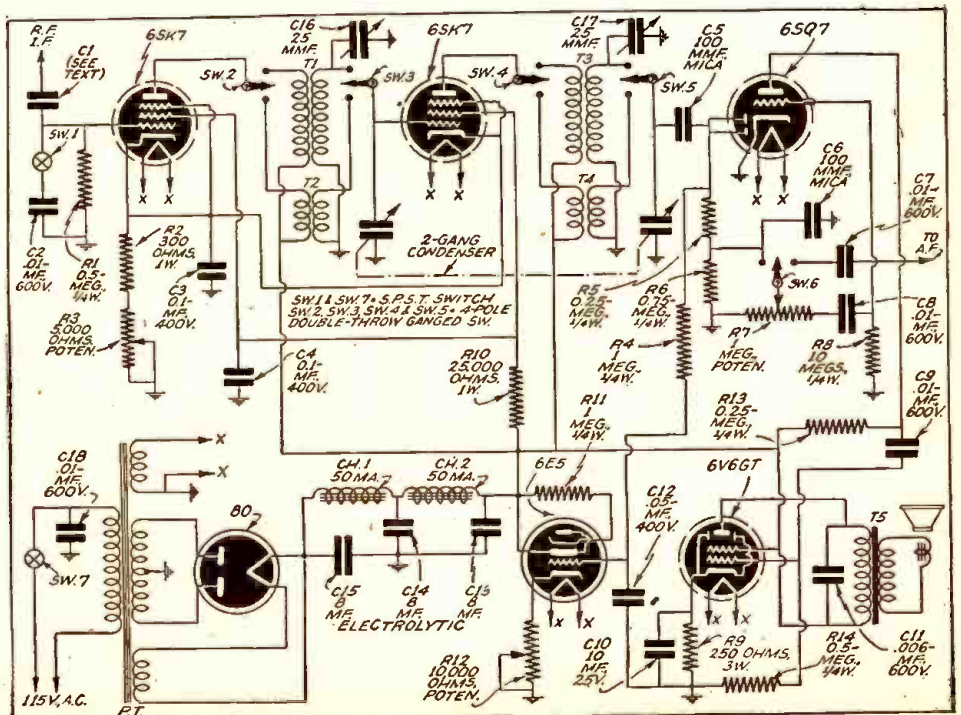

metal tubing about 1/2-in. long that will fit inside the hollow fiber tip is found. An old spacer can usually be found that will do the job. A piece of spaghetti is cut to the exact length of this spacer and slipped inside of it. A 1/4-in. 6/32 bolt with an insulating washer on each end is then slipped inside the spaghetti, and then tightened.

The shielding is then cut back about an inch on the microphone cable and the center wire is soldered to a thin soldering lug that will fit inside the fiber tubing between the spacer and the fiber tubing. The fit must be rather snug. The parts are now assembled as shown in the diagram with the lug squeezed firmly between the spacer and the fiber tubing.

The microphone cable is anchored in the other end of the fiber handle by tapping a hole and screwing a set-screw against the cable, using a small flat piece of metal as a shield to prevent the cable insulation from being punctured.

The A.F. Lead.—The audio lead is made the same way except that the end of the cable is soldered directly to the regular tip instead of to the case of the improvised condenser. Both leads terminate in shielded plugs.

ALIGNMENT

After all the connections have been soldered and the voltages tested, the R.F. lead is plugged-in and connected to a service oscillator. The analyzer band switch is set for the Broadcast Band and the oscillator is tuned to 1,500 kc. The trimmers on the tuning condensers are then lined-up, using the least capacity of the trimmers that will achieve the desired effect. The analyzer is then switched to the I.F. Band and the oscillator tuned to 450 kc. Trimmers C16 and C17 are now lined-up. If the R.F. tip is held between the fingers, local broadcast stations should come in with good volume if the unit is working properly.

The dial is one of small size, with 270° rotation, that happened to be lying around. The original dial scale was removed and a piece of good-grade white drawing paper cut to the same size and inserted. Using the service oscillator again this was directly calibrated from 500 to 1,500 kc. on the broadcast and from 170 to 575 kc. on the I.F. band.

A small 3-inch P.M. speaker is mounted in the right-hand corner of the cabinet. In using the analyzer for "fading" sets, 2 different points can be checked at the same time. The R.F. prod is hooked to the point which it is desired to check, then the attenuator, R3, is adjusted so that the "eye" gives a good deflection. Then R12 is adjusted until the eye just closes; if the signal then changes, the deflection of the eye will easily be seen. The eye will then check the R.F. or I.F. channel for any fading or change in the signal strength. The audio prod is hooked to the point in the audio system to be checked and any change in audio signal strength will be noted in the speaker. If it is desired to check the quality of the R.F. or I.F. signal the audio test lead plug is pulled out and the signal can be heard on the loudspeaker.

The chassis is 6" by 10" by 2 1/2". The cabinet is 7" by 13" by 7 1/2" made by Hadley. Its catalog number is RB 13.

LIST OF PARTS

RESISTORS

Two I.R.C., 0.25-meg., 1/2-W., R5, R13;
One I.R.C., 300 ohms, 1 W., R2;
One I.R.C., 5,000 ohms, type 11-114 volume control (with switch), R3;
One I.R.C., 25,000 ohms, 1 W., R10;
One I.R.C., 0.75-meg., 1/2-W., R6;
One I.R.C., 1 meg., type 13-137 volume control, R7;

One I.R.C., 10 megs., 1/4-W., R8;
Two I.R.C., 0.5-meg., 1/2 W., R1, R14;
One I.R.C., 250 ohms, 3 W., R9;
One I.R.C., 10,000 ohms, type 11-116 volume control, R12;
Two I.R.C., 1 meg., 1/4-W., R4, R11.

CONDENSERS

One special Condenser to be built, C1 (see text);
Five Micamold, 0.01-mf., 600 V., C2, C7, C8, C9, C16, type 310-46;
Two Micamold, 0.1-mf., 600 V., C3, C4, type 310-54;
Two Cornell-Dubilier, .0001-mf., mica, type 1W, C5, C6;
One Cornell-Dubilier, .006-mf., 600 V., type SM-6D6, C11;
One Cornell-Dubilier, .05-mf., 600 V., type SM-6S5, C12;
One Cornell-Dubilier, 10 mf., 25 V., type BR-102, C10;
Three Cornell-Dubilier, 8 mf., 450 V., type BR-845, C13, C14, C15;
Two Mallory, 3-30 mf., type BT967, C16, C17.

TUBES

Two Tung-Sol 6SK7GT, V1, V2;
One Tung-Sol 6SQ7GT, V3;
One Tung-Sol 6V6GT, V4;
One Tung-Sol 6E5GT, V5;
One Tung-Sol 80, V6.

MISCELLANEOUS

One Thordarson transformer, type T-70R20, T6;
One Oxford speaker (with transformer), type 3ZMP, T5;
Two Miller R.F. transformers, type 242 R.F., T2, T4;
Two Miller R.F. transformers, type X727 R.F. (for I.F. stages; see text), T1, T3;
Four octal tube sockets, wafer type;
One 4-prong tube socket, wafer type;
One 5-prong tube socket, wafer type;
One dial, such as Crowe Midget De luxe;
Five bar knobs;
Two Thordarson chokes, 12 hys., type .T47C07, Ch.1, Ch.2;
One small knob for dial;
One Bud jack, open-circuit, type 1324;
One Bud jack, single-closed circuit, type 1325;
One 2-gang tuning condenser such as Meissner, type 21-5229;
One rotary switch such as Meissner, type 24-9202;
One rotary switch, S.P.S.T., Centralab No. 1462;
Two phone plugs such as Bud, type 282;
Six ft. crystal microphone cable;
Two test prod tips; or 8 ins. of 1/4-in. dia. fiber tubing;
One cabinet, Hadley type RB14 (with chassis);
Hardware, screws, etc.

ANOTHER F.C.C. HEADACHE!

To a woman who wants to be guest on the "I'm an American" program, the Commission reiterates that it is without authority to put anybody on or take anybody off the air; that such determination rests with the individual broadcast station. The same explanation is given to another woman who would force radio stations to use a particular song, and to a Dayton listener who protests rendition of classical music in syncopated style, and to a citizens' group which adopted a resolution favoring "less time for broadcast programs of an emotional nature and more time for programs with constructive and educational features." In the case of letters objecting to particular programs the Commission suggests that such comments be transmitted directly to the station involved.

Sylvania

SECTIONAL "STOCK BOY" CABINETS HELP YOU SELL

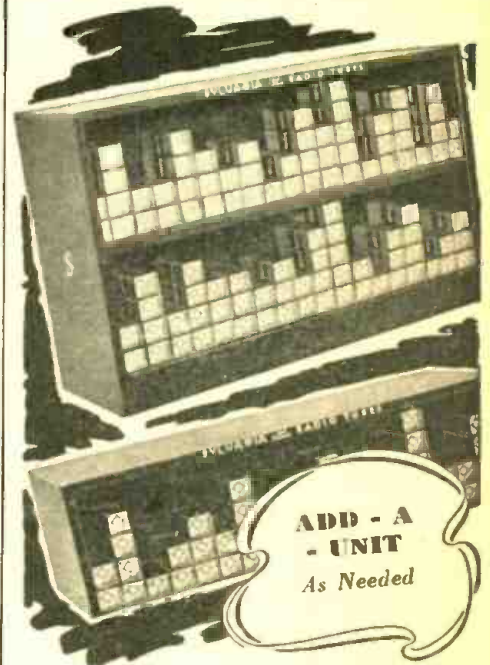

Introducing the new Sylvania Add-a-Unit "Stock Boy"—custom built for radiotube merchandising. You can—

Add shelf sections as needed.
Dress up your store.

Stock tubes for easy accessibility. Eliminate expensive store layout changes incurred by built-in shelves.

Heavy gauge steel . . . coated with rich olive enamel . . . surface will not crack, peel or chip . . . all joints welded . . . light weight.

Each shelf holds from 70 to 140 (one row deep) tubes, or as many as 420 tubes by using the full capacity of the shelf.

Ask your jobber how you can get them.

Sylvania Set-Tested Radio Tubes

**HYGRADE SYLVANIA
CORPORATION**
EMPORIUM, PA.

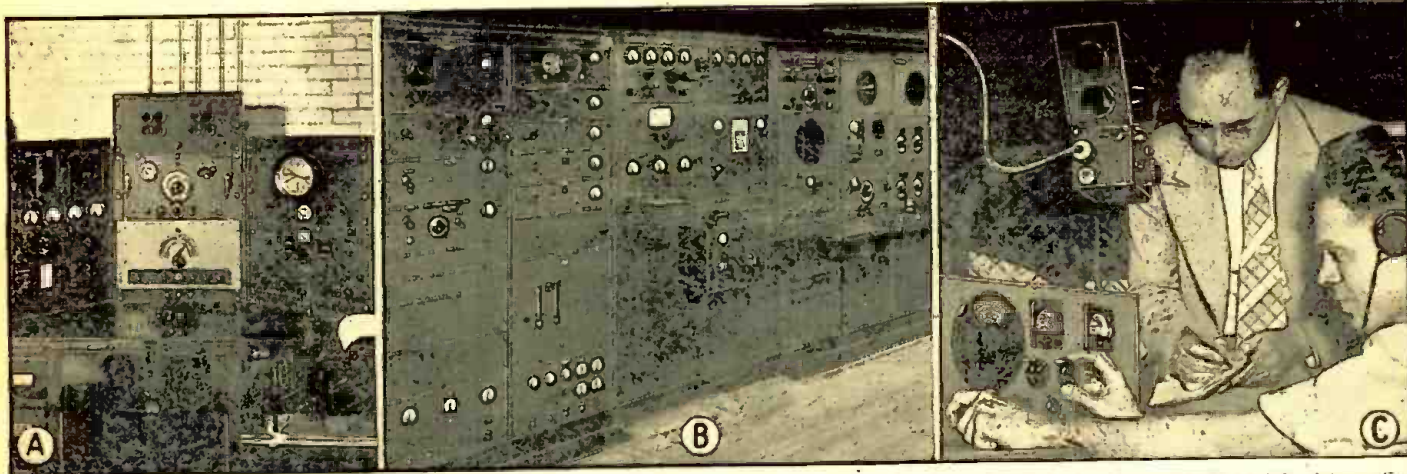

These 3 photos help illustrate the scope of the activities of the Federal Communications Commission. From Washington its long arms reach to every point within its domain, throughout the United States and its possessions. Individually, these photos show: A—Operating position for a ship monitoring station. The picture shows frequency measuring and recording equipment. B—Typical Com-

mission monitoring equipment. This type of apparatus is used for intercepting radio signals and measuring their characteristics. C—Radio direction finder installation in an automobile. Here the Commission inspectors are shown finding a bearing on a radio transmitter installation. Recent newspaper items have told how the F.C.C. has caught many operators of illegal transmitters red-handed.

POLICING THE KILOCYCLES

Though highly complicated to the layman, the technique employed by the Federal Communications Commission in policing the ether lanes, now a 24-hour duty in connection with National Defense, is familiar to radio engineers. It is not only this lay description of the F.C.C.'s activities, as now augmented by the new demands which have been made upon it, which this article presents, but also the more technical engineering technique which is here reviewed. Technicians viewing the F.C.C. with an eye to employment may find this article enlightening.

TO understand *HOW* the Commission patrols the ether, it is first necessary to know *WHY* this is done.

To begin with, the ether highways have their own particular traffic problems. Their increased use has made them as congested as much-traveled land highways. So it is essential to have traffic regulation on both.

Consequently, the various types of radio transmissions are assigned particular ether lanes in which to travel. If one signal strays over its assigned "white line" there is collision with and confusion to other services. Likewise, if a transmission appears in the ether paths without identifying call letters it is as quickly spotted as any auto without license plates trying to traverse a land highway.

The Commission polices this ether traffic mainly through primary Monitor Stations. These stations are really "listening posts" which, because of their geographic locations, can "hear" over the entire nation.

MONITORING FOR DEFENSE

"Monitoring" to see that radio transmissions obey ordinary ether traffic rules has been a practice since the early days of radio regulation. However, normal functions of the Commission have now been augmented to meet national Defense requirements. This supplemental domestic duty is in charge of F.C.C.'s National Defense Operations Section, which was established July 1 of last year. Existing monitoring facilities also record foreign shortwave broadcasts for a special Commission unit, which translates and analyzes the programs so intercepted.

Each F.C.C. monitoring station, in effect, patrols a particular ether "beat." Oftentimes such a station will itself spot an unlawful transmission. At other times suspicious signals are reported by broadcasters and other licensees—often by amateurs, including the transmitting "hams," who do an excellent job of policing their own bands.

No signal is too weak for a monitoring station to pick up and record. When a strange or "reckless driver" is detected on the ether lanes, "direction-finding" apparatus is called into play to trace the culprit.

Sometimes 3 or more stations will collaborate in thus getting a bearing on the suspicious signal. Their beams are plotted on a map. Eventually and inevitably 2 lines will cross. This point, or "fix," marks the general location of the sending set under surveillance.

The final task of running-down the offender is performed by F.C.C. monitoring officers. Such men, highly skilled in radio engineering and radio operation, are assigned to monitoring units dispersed strategically throughout the United States and its possessions. For obvious reasons, locations of such auxiliary "ears" are not made public.

These monitoring posts are provided with automobiles, to all external appearances ordinary cars but which are fitted with the latest and most efficient type of detection equipment. Included are direction-finders, allwave receivers, and recorders. All this apparatus can be operated from the car's battery while the auto is in motion or, upon being removed from the machine, from the power supply of a dwelling, tourist camp, store, etc.

Operation of the mobile equipment follows much the same procedure employed by the monitoring stations in the first instance. Directional beams finally "fix" at the exact location of the transmitter in question. Even if the hunt narrows to an apartment house, hotel, or other large building, an F.C.C. officer can, by using a device concealed in his hand or in his pocket, proceed from floor to floor, and from door to door, and so determine the exact room in which the illegal equipment is being used.

Thus, as George Creel commented in a recent issue of *Collier's*, "the Federal Communications Commission has worked out a system by which it polices the ether as me-

thodically and efficiently as a policeman patrols his beat."

THE 24-HOUR WATCH

The establishment of the special National Defense "Listening Posts" to record, translate, transcribe and analyze foreign shortwave broadcasts was undertaken by the Federal Communications Commission in cooperation with the Defense Communications Board.

This 24-hour watch for subversive and other pertinent radio propaganda from abroad, set up at primary monitoring stations strategically located throughout the United States and its possessions, requires a picked force of 350 technicians, translators, clerks, propaganda analysts and other experts who work in 8-hour shifts to keep abreast of all overseas emissions which may involve propaganda intended for persons in this country or neighboring countries. Such continuous listening is necessitated by the difference in time and propagation characteristics of international broadcasts. The listeners and analysts pay particular attention to voice broadcasts, including news-casts, speeches, announcements and playlets, as well as some musical programs.

After being recorded in the field, all this material is coordinated and studied at Washington. The extent of the work involved is indicated by the fact that it requires an average of 7 hours of translation and transcription to fully process 1 hour of recorded material. It is necessary to record and analyze matter of which 75% is in languages other than English.

This necessary step to deal with vital national Defense problems developed by radio is taken on recommendation of the Defense Communications Board, as approved by the President and the Bureau of the Budget. It has a high degree of cooperation from other Government agencies, which want to be correctly informed on the extent and character of foreign broadcasts reaching this coun-

try. Broadcasters and private propaganda analysis organizations are cooperating in this patriotic endeavor to keep the Government fully informed on the situation in the air.

ADDITIONAL DUTIES

Under this expansion program, which requires 24-hour surveillance of all communication channels, inclusive of broadcast and other radio transmission, preceding radio monitoring facilities were supplemented with 10 primary long-range direction-finder stations. These stations determine the bearings of unauthorized or otherwise suspicious communications. The mobile equipment, which includes direction finding apparatus, traces the origin of such transmissions.

In addition to increased monitoring duties, the Field Division is now required to watch radiotelegraph and radiotelephone circuits for superfluous signals, record same, and translate foreign language broadcast material. It must also make certain of the citizenship of several hundred thousand persons now charged with the responsibility of communications, as well as of their immediate families. This figure covers about 100,000 licensed radio operators, including amateurs; a like number of cable and wire operators, and other employees such as those of broadcast and other radio stations. It is necessary to know more about the private communications employees who daily handle official dispatches and other Government messages.

Another emergency task is the guarding against the possible misuse of electrical apparatus, including diathermy devices (now employed in many thousand offices of physicians), as transmitters in a manner which might jeopardize the nation's security. Still another undertaking is to keep tab on possible use of transmitters which have been manufactured but not sold or licensed for authorized communication purposes.

The Commission previously operated 7 monitoring stations, in various parts of the country, largely devoted to making routine measurements of frequencies and determining the quality of emissions, as well as spotting interference. In the course of such work, they observed unlicensed operation incidentally. However, these monitoring stations as then manned and equipped could not cope with the additional work.

Congress recently authorized a new monitoring station for Massachusetts, but this is to relocate and improve the existing one. The new bases for mobile operation are being established at strategic points throughout the United States and its possessions.

Routine functions of the Field Division, which previously numbered less than 200 persons, embrace inspection of all classes of stations licensed by the Commission, and the issuance of licenses; investigation of complaints of interference and illegal operation; conducting field strength surveys and analyzing signal characteristics; inspecting ship and other marine radio stations, and general regulatory supervision.

During the last fiscal year the Commission investigated more than 1,000 complaints of unlicensed operation, and the number of cases pressing for investigation is growing under the present situation. Experience gained in past investigation of unlicensed stations, particularly in the use of the ultra-high frequencies, has demonstrated the advantage of an inter-radio communication system for the purpose of synchronizing operations and exchanging intelligence. The new primary monitoring stations and mobile units will be equipped with transmitters and receivers so as to be able to more quickly run down unlawful operation.

Since the Commission is under Civil Serv-

ice, the additional personnel has come and will come from those rolls.

The following, more detailed description of the activities of the F.C.C., by supplementing the above outline of the augmented, Defense monitoring program, presents the picture as it was up until the inauguration of this program, when the ether lanes were patrolled by only 26 offices located strategically throughout the United States and its possessions, augmented by 7 monitoring stations—at Atlanta, Baltimore, Boston, Grand Island, Nebr.; Great Lakes, Ill.; San Pedro, Cal.; and Portland, Ore.

ROUTINE ACTIVITIES

The monitoring stations, in general, do not participate in the investigation of "pirate" or other unlicensed stations other than to report and record their signals as proof of operation. This task is performed mainly by inspectors.

The (then) 115 inspectors in the Field Division are radio engineers, selected through Civil Service competitive examination, and, in addition, are capable radio operators, many having had previous experience in maritime, aviation, and other communications services. They are familiar with the procedure employed by authorized stations, including the military, and this assists them in uncovering illicit operations.

Besides investigating unlicensed stations, these experts inspect all classes of radio stations—Broadcast, Police, Ship (domestic and foreign), Amateur, Aviation, and Television; examine radio operators for various classes of licenses; monitor radio transmission for adherence to frequency, quality of emission and compliance with prescribed procedure; and, investigate complaints of interference to radio reception.

The Federal Communications Act specifically prohibits the transmission of information concerning lotteries and other similar schemes. Licenses have been revoked for using obscene and indecent language on the air. Certain announcements are required of broadcasting stations, including identification. The law prohibits the transmission of false distress signals and the rebroadcasting of certain programs, except with authority of the originating station. A certain radio station was reprimanded recently for intercepting, decoding, and broadcasting secret radio communications of the British and German governments, in violation of the Federal Communications Act and treaty obligations. Also, there is definite provision in the Act requiring regulation by the Commission "for the purpose of the national defense."

Though highly technical to the layman, the apparatus and technique employed by inspectors are well known to radio engineers. Advantage is taken of certain factors such as the directive properties of antennas, attenuation of field intensity with increased distance from the transmitting antenna and skip distance phenomena.

In many cases of unlicensed operation in the broadcast band from 550 to 1,600 kilocycles the inspector gains his information on the basis of complaints of broadcast listeners, particularly the ardent DX'ers, who are constantly striving to identify foreign stations and are quick to note appearance of a strange station in the band.

Frequently, an unlicensed station operating in the amateur "ham" bands first comes to the attention of an inspector when investigating a complaint of interference in the home of a broadcast listener by recognizing the interference as originating from key clicks in a telegraph transmitter even though the frequency of operation may be in a band many kilocycles removed from the broadcast band. Field offices also receive tips from the monitoring stations concerning the operation of illegal stations.

46

USABLE RANGES



SUPREME 592 MODEL SPEED TESTER

Service men who know the principle of Model 592 operation will never go back to rotary switch or pin jack operation. 46 ranges at your finger tips!

1 MICROAMPERE TO 14 AMPS: 8 ranges (1-70/700 microamps; 7/35/140/350 M A; 1.4/14 amps.)

0.1 TO 1400 D.C. VOLTS: 7 ranges at 1000 ohms per volt and 7 ranges at 25,000 ohms per volt sensitivity of: (0.1-3.5/7/35/140/350/700/1400) Double Meter Sensitivity.

1/4 OHM TO 50 MEGS: 6 ranges (1/4-500/5,000/50,000/500,000 ohms and 5/50 megohms). All from self contained battery power.

0.1 TO 1400 A.C. VOLTS: 6 ranges (0.1-7/35/140/350/700/1400). Temperature compensated—rectifier guaranteed.

COMPLETE OUTPUT RANGES: 6 ranges (0/7/35/140/350/700/1400). No external condenser necessary.

—10 TO +46 D.B.: 5 ranges 0.006 to almost 200 watts — (-10/+6; 0/+16; +10/+26; +20/+36; +30/+46). Reads direct on 500 ohm line. Chart supplied for reading any-line of known impedance.

Four years actual field use by thousands of Service Men prove the 592 to be TOPS in instrument value. See your Jobber or write Dept. RC-7 for information.

SUPREME

GREENWOOD, MISSISSIPPI, U. S. A.

Sensational New!

"WALSCO UNIBELT"

ADJUSTABLE DIAL BELT

THE GREATEST TIME SAVER FOR RADIO MEN IN YEARS!

Belts are adjustable and come apart. They can be installed without taking the dial mechanism apart. Patented zipper-like fastener gives instant connection. The WALSCO UNIBELT cannot slip or stretch and one can do a replacement job in two minutes that before took an hour or more!

Ask your jobber for FREE WALSCO CATALOG No. 42-A Or write to WALTER J. SCHOITZ CO. 5246 Pico Blvd., Los Angeles, Calif.

GOLDENTONE... 50% OFF

30 DAY TRIAL

49¢

5 UP TO 12 TUBES

NO PLAY

YEAR GUARANTEE

DEAL DIRECT FACTORY PRICES.

Over 75 models to choose from—4 to 12 tubes. Portables \$8.98 up. Firm sets \$8.98 up. Car sets \$8.98 up. Foreign band sets \$8.98 up. Samples 50% off. Quantity discounts. Free 1942 Bargain catalog gives details of 10 day FREE trial, agent's proposition and discounts. No obligation. Mail postcard to:

GOLDENTONE RADIO CO., DEPT. RC, DEARBORN, MICH.

Free Catalog

RCA

LICENSED



Actual installations of the loudspeakers at Ravensloe Country Club in Homewood, Ill. A.—Two 12-in. loudspeakers each on opposite sides of the pool give good coverage; only the closer loudspeaker appears in the view. A microphone connection is also located here. B.—A single projector speaker affords adequate coverage for the patio. C.—One speaker fastened to the beam is more than sufficient for each of the locker rooms. D.—In the dining room a 12-in. P.M. speaker and a microphone input are used. The living room set-up is similar.

A MODERN 50-WATT P.A. INSTALLATION

Featuring Ease of Operation and Great Versatility

The sound installation here described has been prepared as an object lesson designed to answer the majority of the questions customers ask Public Address specialists. The article is planned to answer these questions even though the customer may be interested in an entirely different application than the one described here; as, for example, sound for an auditorium, church, office, or factory, etc., instead of the illustrated set-up at a country club in Illinois.

L. M. DEZETTEL

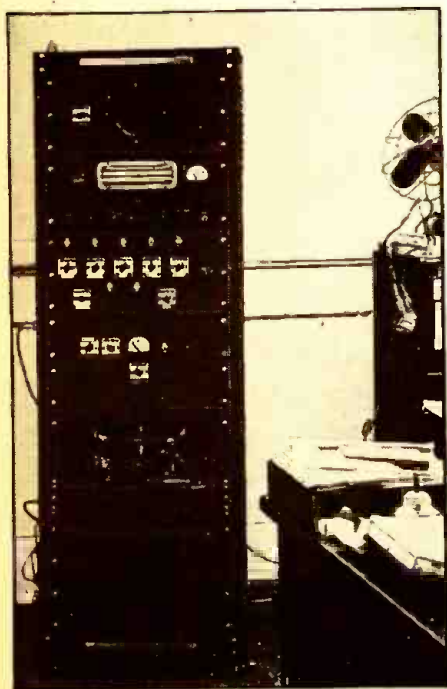

Rack and panel amplifier unit. Normally it is located at the immediate left of the telephone switchboard.

ABOUT 90% of Public Address installations do not present much of a problem. Most installations are for a specific purpose, such as for the amplification of a speaker's voice from the stage of an auditorium, or the pulpit of a church, for paging systems in offices and factories, for band-shell use and many others.

But when your customer says: "What do you suggest?" or "What's new?", then we should stop and give the matter a little thought. We want to give our customer the latest in public address equipment, even though we know there isn't much "new" in the field. We can make it "new" by using a little common sense in its application, in its diversification, and in giving a thought to preventing obsolescence.

Above all, keep in mind ease of operation. You must remember that whoever is to operate the system once it is installed, must not be expected to have a technical knowledge of its function. Keep the controls simple and properly marked so that the caretaker of the building, the handyman, a telephone operator, the proprietor or other persons who may be operating the system need not be a graduate engineer.

RAVENSLOE COUNTRY CLUB

Just by way of illustration, let us describe an installation recently made at the Ravensloe Country Club in Homewood, Il-

linois. While there are undoubtedly fancier installations than this somewhere in the nation, we tried to keep in mind all of the points mentioned above.

The system consists of essentially an F.M.-A.M. radio tuner, a record player, a 50-watt amplifier, a V.I. meter and monitor speaker, and speaker control panel, all built "rack and panel" style. A total of 9 P.M. loudspeakers fed by 6 individually-controlled speaker lines, and 3 microphone lines are the external connections.

Now, let us consider each of the component parts of this system separately. The amplifier used was a standard KNIGHT 50-watt unit, with a sloping panel and many more controls than we needed for this application. It was mounted back of a standard relay rack panel and those controls which we considered essential to this application were brought out to the front panel by means of flexible shafts. Only 2 of the 4 microphone inputs were needed, so the front panel finally contained only the 2 microphone controls, a master gain control, the V.I. meter, a fuse holder, and the A.C. "ON-OFF" switch.

The F.M.-A.M. tuner is a Hallicrafters model S-31 standard unit, which is already supplied for rack and panel mounting. Here is a feature which you should not overlook. With Frequency Modulation making tremendous strides, an F.M.-A.M. tuner be-

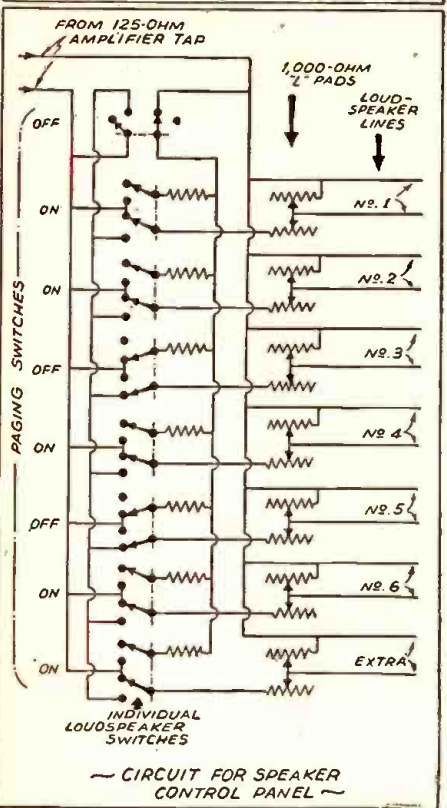
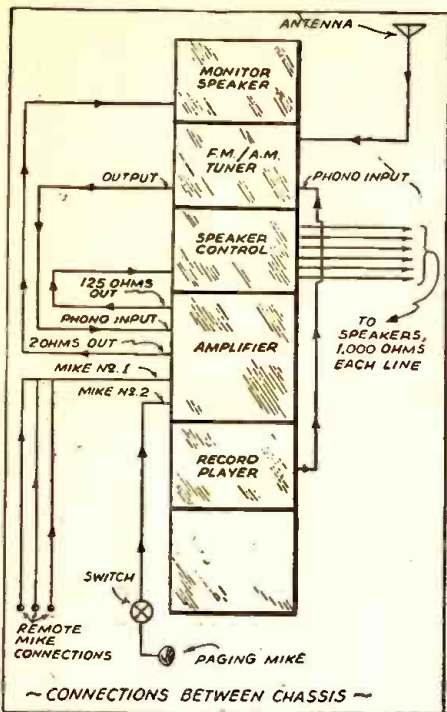

comes a "natural" as an addition to any high-quality P.A. system. The amplifier used has a frequency response essentially flat from 40 to 10,000 c.p.s. The speakers used are the new-type Jensen with extended frequency range designed especially for F.M. reproduction. The results were astounding. The entire country club was flooded with music so remarkably brilliant that the music, instead of serving as a background for other activities, became the center of attention of all of the guests.

The F.M. tuner was connected to the phono input of the amplifier. The phono control on the amplifier was set at full volume but the control shaft was not brought out to the front panel. Instead, control on the phono channel was all done with the volume control on the F.M.-A.M. tuner. The G.I. record changer unit was connected to the phono input on the F.M.-A.M. tuner, and its

volume was controlled by the F.M.-A.M. volume control.

Microphone connections were installed at the swimming pool, the dining room, and the living room. The microphone cables were connected in parallel and brought to the amplifier as a single microphone line. This permitted their carrying swimming events, and orchestral music from the living room or dining room, over the entire system. A Shure Unidyne microphone with 50 ohms output impedance, on a floor stand, was used to plug in at any of the three input connectors. One of the new cable-type Thordarson microphone matching transformers was used right at the microphone input connector of the amplifier to step up the 50-ohm line to high impedance.

An American high-impedance dynamic mike was installed at the telephone operator's switchboard and connected by a short length of cable to the other microphone input on the amplifier. A "push-to-talk" switch was installed at the switchboard. This microphone was to be used for paging only.

A speaker control panel such as was used here is almost a "must" where a number of speakers are used in different locations and require different volume settings. The speaker control panel was fed from the amplifier's 125-ohm output tap. Individual control of 7 different speaker lines (6 now in use—1 for the future) is accomplished by the use of Utah LA-1000 "L" pads. Each line also has an "ON-OFF" switch consisting of a double-pole double-throw toggle switch and a 1,000-ohm, 10-watt fixed resistor acting as a dummy load when the speaker is off. Each of the speaker lines may be adjusted to a volume setting suitable to the locations.

Any of them, or all of them, may be cut in or out for the reception of regular program material. A double-pole-double-throw

switch is hooked up in such a way that all of the speakers may be thrown on instantly, for paging purposes.

Six speaker lines made of ordinary twisted-pair wire feed the living room, locker rooms, swimming pool, patio, dining room, and grille room. With the exception of the swimming pool, dining room and grille room, each of the lines terminated in a matching transformer, to match 1,000 ohms to the voice coil impedance of the speaker. Jensen PM-12CT speakers were used throughout, except in the grille room. Wall baffles were used inside and weatherproof projectors used on the patio and at the swimming pool. The two speakers at the swimming pool were connected in parallel at the transformer. The transformer tap was set at 2,000 ohms. Two loudspeakers in the dining room were handled in the same way. The speaker line into the grille room branched off into the bar room next to it. Jensen PM-8CT speakers were used in these two rooms.

A small 5-inch P.M. speaker is mounted in the top panel for monitoring purposes. It is fed from the 2-ohm output on the amplifier and has a 500-ohm series rheostat in one lead.

The speaker control circuit, too, may well be applied to almost any P.A. installation.

Above all, if you are located anywhere near an F.M. station, or where the construction of one is contemplated, be sure to include an F.M. tuner in your suggestions to your customer. This, especially, is the "something new" that you can offer him, and when the installation is finally made, your customer's enthusiasm at the fine quality of music obtainable will turn out to be a business-bringing word-of-mouth advertisement for your establishment.

This article has been supplied from material supplied by courtesy of Allied Radio Corp.

Never Before!

AN ECONOMICAL HIGH-FIDELITY REPRODUCER — with HIGH FREQUENCY CONTROL

- ★ SO MUCH PERFORMANCE!
- ★ SUCH COMPLETE VERSATILITY!
- ★ AT SO LOW A COST!

When you buy a new **JENSEN Coaxial Reproducer**

Designed by acoustical engineers to give sound experts and music lovers the best in sound reproduction. These new reproducers are so advanced in performance that obsolescence is eliminated for years to come... yet now, with the new H.F. Control, you can instantly adjust response for greatly improved results with every type of input in use today. Ideal for professional and home use for FM-AM reception and monitoring, transcriptions, commercial phono records, for practically every quality application... yet prices are surprisingly low!

Write today for complete information on these fine reproducers. Get full details on these important features... TWO SPEAKERS COAXIALLY MOUNTED... BUILT-IN FREQUENCY DIVIDING NETWORK... JENSEN HIGH FREQUENCY CONTROL FOR ALL-PURPOSE ENCLOSURE... JENSEN "BASS REFLEX" ENCLOSURE FOR FULL LOW REGISTER... NEW, BEAUTIFULLY STYLED WALNUT CABINETS.

7 complete-reproducer models to choose from. Coaxial speakers only as low as \$29.50 list (less H.F. Control.)

Some models have "shelving" H.F. Control system.

Jensen

MAIL THE COUPON TODAY!

RADIO MFG. CO. 6601 S. Laramie Ave., Chicago, Ill.

Please send Bulletin 128C and complete technical description and prices on the new Coaxial Speakers and Reproducers.

NAME _____

ADDRESS _____

CITY _____ STATE _____

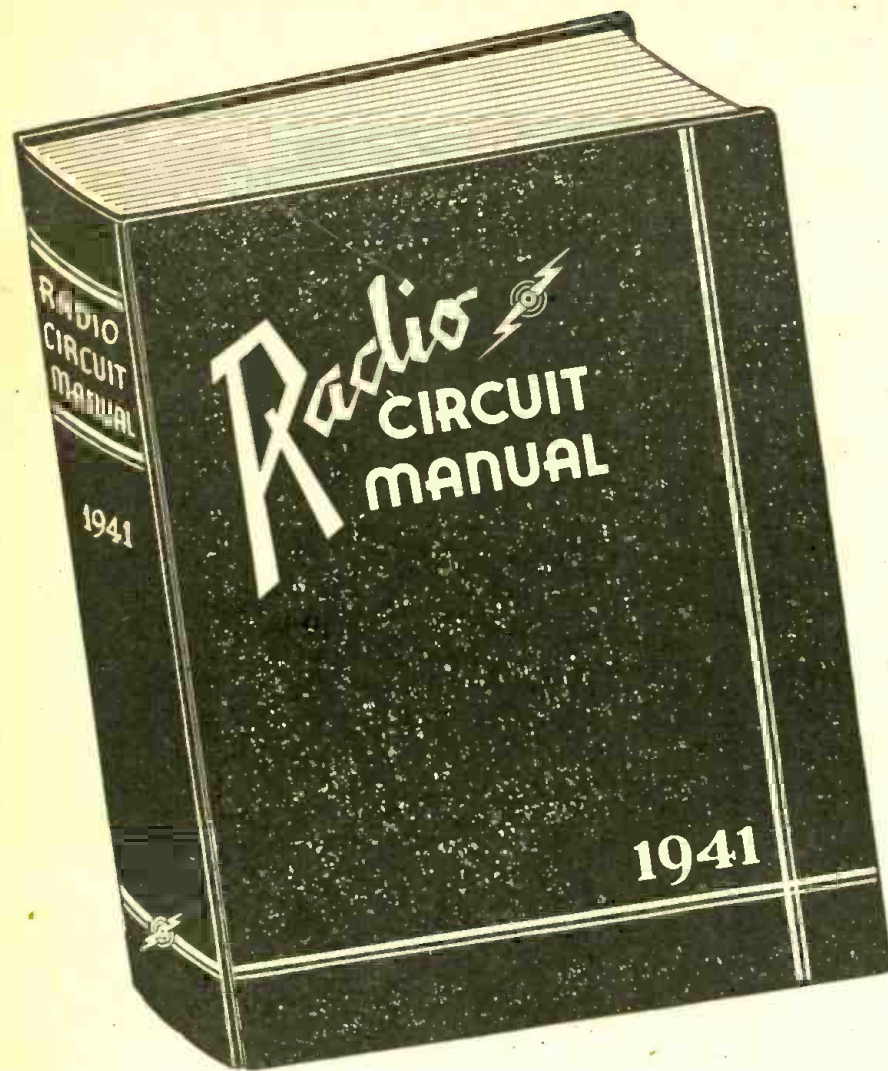

A New RADIO

**The Only EDITED Manual
Ever Published!**

**DIRECTORY OF RECEIVERS
MANUFACTURED IN 1940
AND UP TO JUNE, 1941**

OUTSTANDING FEATU

- Contains data on more than 1800 receiver models!—more than any other radio service manual.
- Only 736 pages!—less than half the bulk of any other manual and more than 1/3 lighter.
- All information is EDITED!—all non-essential data deleted and the balance checked and correlated with the schematics and sketches.
- 40% larger p of all informa (A few unac cepted.)
- I.F. peaks fo cuits are bo black boxes;- accurate.
- No space wast tions and exp lifiers, elect ruments, et ice Engineer's

A "CUSTOM-TAILORED" MA FOR SERVICE ENGINEER

Here, at last, is a Service Manual deliberately PLANNED for the Service Engineer. Instead of a mere hodge-podge collection of service data, as manuals have been, this RADIO CIRCUIT MANUAL is an orderly compilation of essential and service information, carefully edited and uniformly presented for the convenience of the busy Service Engineer. All time-consuming, non-essential information has been weeded out, and the remaining information, vitally important to the servicing of modern radio receivers, has been laid out in a logical, systematic manner, which cuts time from the day's work. Because of this and other features, it has been possible to list all information on a single page.

In 736 pages this Manual presents essential service data on over 1800 receiver models more than any other existing service manual on the market!

ONLY ONE MANUAL PER YEAR

The new technique used in compiling this RADIO CIRCUIT MANUAL has made it possible to include in a single book all the new receiver models which can be produced in a single year. This factor alone represents an important advance for Service Engineers.



← THE OLD TYPE MANUALS—Bulky, heavy, hard to handle, space consuming, less USEFUL data despite greater number of pages.



→ OUR NEW MANUAL—Lighter, compact, easy to handle, takes half as much room on the shelf, more USEFUL information despite fewer number of pages.

MANUALS NOW READY!

RADCRAFT PUBLICATIONS, INC., 20 Vesey St., New York, N. Y.

Gentlemen: Enclosed find my remittance of \$10.00, for which send me, POSTPAID, my copy of the RADIO CIRCUIT MANUAL—1941.

Name

Address

City State

RC-1041

(Send remittance in form of check or money order; register your letter if you send cash.)

ORDER YOUR MANUAL IMMEDIATELY—NOW!

Get your copy directly from us by filling out and mailing the convenient coupon shown at left, or get it directly from your favorite distributor.

736 pages; size 13 1/8 x 10 1/4 x 2 in. thick; loose leaf, leatheroid-covered stiff binder; net weight 6 1/2 lbs.

ONLY
10.00

This Re time prop Circuit 3 and so o the other expeditini ticing Se

RADCRAFT PUBLICATIONS
20 VESEY ST.

Type of Service Manual!

CIRCUIT MANUAL—1941

MORE INFORMATION IN HALF THE NUMBER OF PAGES

The value of a service manual is measured not by the number of pages but by the amount of useful information. Thus, in only 736 pages this Radio Circuit Manual covers over 200 receiver models MORE than does any other competitive manual in twice the number of pages.

HOW DID WE DO IT?

By increasing the size of our page; by discarding non-essential data, and editing the balance; by listing only those

receivers which the Service Engineer will definitely have to repair (no communications or export receivers, no shortwave sets or amplifiers, no electronic devices, etc.); by many months of hard work based on a definite plan of procedure and a clear understanding of the actual requirements of the Service Engineer. There is no "dead weight" information to add bulk to this Manual. Every word counts. Every minute of reading time is well spent.

ES

permits listing on one page. double cases ex-

all superhet cir- y displayed in one missing, all

on communica- receivers, am- ic musical in- a 100% Serv- manual.

UAL

Service Engineer. In- teen in the past, radio diagrams maximum con- data have been id and efficient y-reading style which are self- pertaining to a

ceiver models;—

R!

-1941 makes it e radio industry at saving to all

PERMANENT INSTITUTION

Circuit Manual—1941 is NOT a one- on. Next year there will be a Radio al—1942, the following year, 1943 definitely—each Manual better than new methods are worked out for simplifying the work of the prac- Engineer.

S, INC. YORK, N. Y.

SPECIMEN PAGE
(greatly reduced)
THE ACTUAL PAGE SIZE IS
10 By 12 3/4 inches

ALIGNMENT PROCEDURE

Be sure to follow procedure carefully and in the order given—otherwise the receiver will be insensitive and the dial will be erratic. For alignment procedure read instructions from left to right. If more than one adjustment is required check and readjust dial adjustment by tuning gang condenser until pointer touch maximum capacity step (completely to the right) at which point the dial needle must be exactly even with the last line of the low frequency end of the dial calibration. If dial needle does not point exactly to last line move to correct position. Use an accurately calibrated test oscillator with scope type of output measuring device. Have ground lead of test oscillator attached to chassis.

TEST OSCILLATOR		RECEIVER ADJUSTMENTS	
Set receiver dial to 550	Adjust test oscillator frequency to 455 K. C.	Use dummy antenna in series with output of test oscillator consisting of:	Adjust output of test oscillator to 100 microvolts
Any point where no interfering signal is received	455 K. C.	.02 MFD. condenser	Adjust each of the second I. F. transformer trimmers for maximum output—then adjust each of the first I. F. trimmers for maximum output.
1 Exactly 1730 K. C.	Exactly 1730 K. C.	2000S MFD. condenser	Receiver blue antenna lead
2 Approx. 1400 K. C.	Exactly 1400 K. C.	2000S MFD. condenser	Receiver blue antenna lead
3 Approx. 600 K. C.	Approx. 600 K. C.	2000S MFD. condenser	Receiver blue antenna lead

Qty	Part No.	Description
1	1181	Cable
1	1182	Coil
1	1183	Coil
1	1184	Coil
1	1185	Coil
1	1186	Coil
1	1187	Coil
1	1188	Coil
1	1189	Coil
1	1190	Coil
1	1191	Coil
1	1192	Coil
1	1193	Coil
1	1194	Coil
1	1195	Coil
1	1196	Coil
1	1197	Coil
1	1198	Coil
1	1199	Coil
1	1200	Coil
1	1201	Coil
1	1202	Coil
1	1203	Coil
1	1204	Coil
1	1205	Coil
1	1206	Coil
1	1207	Coil
1	1208	Coil
1	1209	Coil
1	1210	Coil
1	1211	Coil
1	1212	Coil
1	1213	Coil
1	1214	Coil
1	1215	Coil
1	1216	Coil
1	1217	Coil
1	1218	Coil
1	1219	Coil
1	1220	Coil
1	1221	Coil
1	1222	Coil
1	1223	Coil
1	1224	Coil
1	1225	Coil
1	1226	Coil
1	1227	Coil
1	1228	Coil
1	1229	Coil
1	1230	Coil
1	1231	Coil
1	1232	Coil
1	1233	Coil
1	1234	Coil
1	1235	Coil
1	1236	Coil
1	1237	Coil
1	1238	Coil
1	1239	Coil
1	1240	Coil
1	1241	Coil
1	1242	Coil
1	1243	Coil
1	1244	Coil
1	1245	Coil
1	1246	Coil
1	1247	Coil
1	1248	Coil
1	1249	Coil
1	1250	Coil

SOUND ENGINEERING

Free Design and Advisory Service
For Radio-Craft Subscribers

Conducted by A. C. SHANEY

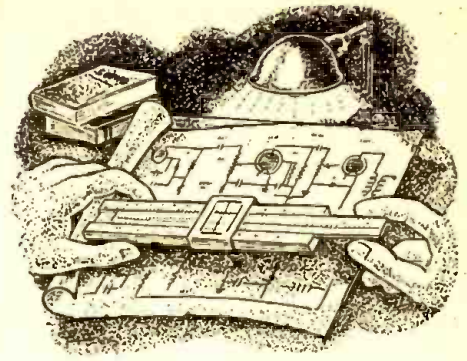

This department is being conducted for the benefit of RADIO-CRAFT subscribers. All design, engineering, or theoretical questions relative to P.A. installations, sound equipment, audio amplifier design, etc., will be answered in this section. (Note: when questions refer to circuit diagrams published in past issues of technical literature, the original, or a copy of the circuit should be supplied in order to facilitate reply.)

No. 22

ADDING BASS BOOST

The Question . . .

Your magazine is truly a magazine for the Serviceman and it is 100% as it is. I have seen some criticism in the Mailbag Department; you cannot please everybody and besides I wonder what some people want for 25c? The Sound Engineering Department of your magazine is worth very much more. Some people do not stop to

think how much money it would cost them if they had to bring their problems to consulting engineers and yet Radio-Craft gives it to subscribers free for the asking.

Enclosed is a circuit diagram (Fig. 1) of my amplifier, you will note that it has 2 microphone inputs. I have use for one only and I should like to use the other 6J7 tube as a bass booster or bass amplifier to increase the bass response of the amplifier. If possible the booster should have a con-

trol to enable me to adjust the amount of bass response. I do not mind adding another tube if necessary.

EDUARDO CRESPO,
Cabanatuan, N. E.,
Philippine Islands.

The Answer . . .

There are a number of simple methods of adding bass boost to your amplifier, but I believe it advisable to add both low-frequency bass and cut as well as a high-frequency bass and cut. Particularly in view of the fact that a minimum amount of parts are required to give you the extreme flexibility offered by such a versatile arrangement.

If you will refer to the August 1940 issue of Radio-Craft, page 101 (Fig. 1), you will find the desired type of equalizer circuit indicated between the 6SC7 electronic mixer and the 6SC7 inverter. By inserting this portion of the circuit between your 6N7 electronic mixer, and 6N7 inverter, you will be able to obtain the desired circuit flexibility. You should, of course, eliminate your present low- and high-frequency attenuating networks.

WHAT CAUSES DISTORTION?

The Question . . .

I am enclosing the circuit of my record player amplifier which does not give me satisfaction. At low amplification the sound is very good, but distortion comes when amplification is set at a higher volume. The transformers are supposed to be of good quality.

Could you suggest some change I may make in the circuit to improve this amplifier?

GEO. DESILETS,
Nicolet, P. Q.,
Canada.

The Answer . . .

Your letter is typical of hundreds received which cannot be intelligently answered because of insufficient data.

You see, Mr. Desilets, we could easily write a book on all of the possible sources of distortion in a normal reproducing system. Did it ever occur to you that the distortion may be caused by your phono pickup, phonograph needle, loudspeaker, speaker baffle, or any other auxiliary component?

The design of your circuit (Fig. 2) appears to be satisfactory. If the amplifier was wired accordingly, distortion is probably caused by overload of either the output stage or the loudspeaker. You can easily tell which of the two is causing trouble by terminating the 500-ohm tap of the output transformer across a 500-ohm resistor, and check the waveform of the voltage developed across this load.

If oscilloscopic observation or harmonic analysis indicates lack of objectionable distortion when your amplifier control is set for higher volume, then the distortion is most probably being introduced by the loudspeaker.

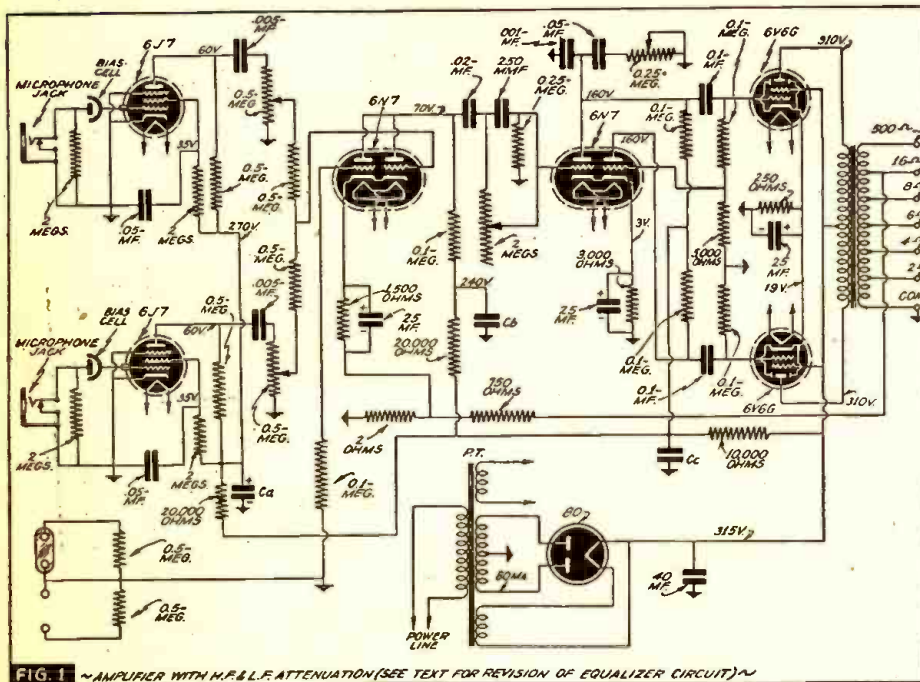

FIG. 1 ~ AMPLIFIER WITH H.F. & L.F. ATTENUATION (SEE TEXT FOR REVISION OF EQUALIZER CIRCUIT) ~

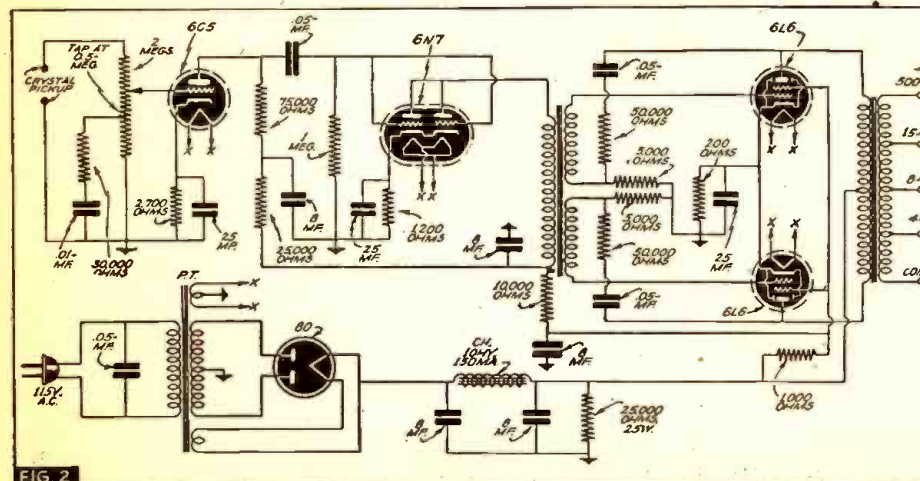

FIG. 2

THIRTEEN FM STATIONS NOW ON FULL COMMERCIAL BASIS

Vanguard of the increasing number of F.M. broadcast stations supplying service across the country, 13 of the new noise-free, full-fidelity transmitters are now operating on a regular commercial basis.

Figures from makers of F.M. receivers show that the total of sets sold during June was double that of May. And, further indication of FM's rapid growth, June sales boosted the number of F.M. receivers in use by almost 25%!

Commercial F.M. stations on the air today in 11 major trading areas provide program schedules ranging from 10 to 18½ hours daily. In almost every case, program material is 75% to 100% original and non-duplicated by any other broadcast station in the same area.

Commercial stations now on the air include:

W39B—The Yankee Network, Sargent's Purchase, N. H. (This transmitter is located atop Mount Washington, highest point in the northeast U.S., servicing 31,000 square miles in New Hampshire, Vermont and Maine, most of which has never before enjoyed adequate radio reception.)

W43B—The Yankee Network, Boston, Mass. (A 50,000-watt F.M. station serving 18,647 square miles within a radius of 100 miles, including all of Massachusetts and Rhode Island, half of Connecticut and parts of New Hampshire, Vermont and Long Island.)

K45LA—Don Lee Broadcasting System, Hollywood, Calif. (The latest commercial F.M. station on the air. Employs a temporary power of 1,000 watts to cover Los Angeles and Hollywood from atop 1,700-foot Mount Lee. First commercial F.M. transmitter on Pacific coast.)

W45D—The Detroit Evening News, Detroit, Mich. (Now operating at reduced power of 3,000 watts to cover all of Detroit and suburbs. A 50,000-watt transmitter is being installed to serve 6,820 square miles of heavily populated territory.)

W45BR—Baton Rouge Broadcasting Co., Baton Rouge, La. (Serves an area of 8,100 square miles in Louisiana, and is first F.M. station in the deep South.)

W47A—Capitol Broadcasting Company, Schenectady, N. Y. (Supplies 16½ to 18½ hours of F.M. programs daily throughout the Albany-Schenectady region. Began operations on a profit basis with 36 commercial sponsors.)

W47NV—National Life & Accident Co., Nashville, Tenn. (A 20,000-watt F.M. transmitter covering 16,000 square miles, W47NV was the first commercial F.M. station in the world to be completed. It also aired the first commercial F.M. program.)

W49D—John Lord Booth, Detroit, Mich. (Operates with temporary power of 1,000 watts to cover the metropolitan Detroit area.)

W51C—Zenith Radio Corporation, Chicago (Chicago's first commercial F.M. station, W51C is licensed to serve 10,800 square miles—an area embracing all of Chicago and outlying territory. At present it is the only F.M. transmitter on the air in that city.)

W51R—Stromberg-Carlson Telephone Mfg. Co., Rochester, N. Y. (Operates 14 hours daily, serving an area extending 25 to 30 miles from Rochester, touching 8 different upstate New York counties.)

W55M—The Milwaukee Journal, Milwaukee, Wis. (This station employs a temporary power of 1,000 watts to reach a circle of listeners up to 25 miles from downtown Milwaukee. A new 50,000 watt transmitter is being installed.)

JUST OFF THE PRESS!

A. A. Ghirardi's REVISED and ENLARGED (New 2nd Edition) RADIO *Trouble-Shooter's* HANDBOOK



40% BIGGER!
The service man's most helpful Handbook! Thousands of repair shops have used the old edition daily in their work—this new one is 40% BIGGER and BETTER than ever.

NEW FROM COVER TO COVER!

Every page completely revised and brought up to date—and 202 pages of additional new material added.

SEND FOR TRIAL COPY
For the sake of your own business see a copy of this new Handbook without delay. Use the coupon. Our Money-Back Guarantee protects you.

MAKE MORE MONEY BY BEING A FASTER TROUBLE-SHOOTER!

Ghirardi's New HANDBOOK is equal to reams of magazine clippings, service notes, manuals, catalogs, and thousands of hours of trouble-shooting experience when it comes to finding and remedying troubles quickly. You will do your trouble-shooting and repair work EASIER, BETTER, FASTER with its help. Be a master of radio trouble-shooting and diagnosing.

QUICK FACTS ABOUT IT FOR BUSY SERVICE MEN:

1. Trouble "Case Histories" for 4,600 Receivers and Record Changers (largest compilation ever published)
2. Alignment Data for 20,000 sets
3. 60 pages of Auto-Radio Servicing data
4. Battery Replacement Charts for 1,200 Portable Sets
5. 37 Pages of Tube Data Charts (Covers every tube ever made)
6. 59 other invaluable Charts & Data compilations
7. All data carefully arranged and indexed for INSTANT REFERENCE

Now increased to

710 BIG MANUAL-SIZE PAGES

CHECK FULL OF VITAL TIME-SAVING DATA FOR 1942 SERVICING

THIS CCUPON BRINGS IT TO YOU!

CLIP OUT — mail TODAY!

RADIO & TECHNICAL PUBLISHING CO. (Dept. RC-101)
45 Astor Place, New York, N. Y.

Please send the books checked below. My satisfaction is guaranteed!

RADIO TROUBLE SHOOTER'S HANDBOOK \$3.50 Ghirardi's **MODERN RADIO SERVICING \$4** **BOTH books at MONEY-SAVING Combination Price \$7**

NAME

ADDRESS

CITY STATE

Check here for FREE Circulars!

— YOUR MONEY BACK IF NOT COMPLETELY SATISFIED! —

W65H — WDRC, Incorporated, Hartford, Conn. (Serves northern Connecticut with a 1,000-watt transmitter atop Meriden Mountain, with consistent listeners within 30-mile range.)

W71NY—Bamberger Broadcasting Service, New York City (New York's first commercial F.M. station, W71NY is now installing a 10,000-watt transmitter to be ready by mid-August. It will permit coverage of 8,500 square miles—up to 50 miles airline from Manhattan.)

In addition to the 13 commercial stations listed, there are also 15 experimental transmitters on the air daily. Most of these supply regular program schedules but are not yet permitted to sell air time. Among them are:

W1XTG—Worcester Telegram Publishing Co., Worcester, Mass.

W1XK—Westinghouse Radio Stations, Inc., Boston, Mass.

W1XSN—Westinghouse Radio Stations, Inc., Springfield, Mass.

W1XSO—Travelers Broadcasting Service, Hartford, Conn.

W2XMN—Edwin H. Armstrong, Alpine, N. J.

W2XQR—Interstate Broadcasting Company, New York City

W2XWG—National Broadcasting Company, New York City

W3XO—Jansky & Bailey, Washington, D. C.

W3XMC—McNary & Chambers, Washington, D. C.

W2XOY—General Electric Company, Schenectady, N. Y.

W8XAD—WHEC, Inc., Rochester, N. Y.

W8XVH—WBNS, Inc., Columbus, Ohio

W8XFM—Crosley Radio Corporation, Cincinnati, Ohio

W9XER—Midland Broadcasting Co., Kansas City, Mo.

W9XYH—Head of the Lakes Broadcasting Co., Superior, Wis.

AUTO-RADIO

at its Best



• That choice of types precisely fitted to different phases of the noise-suppression job, is provided by more than a dozen and a half different Aerovox types. Also the necessary choice of capacities and voltages. And each unit is designed and built for the severe-service conditions of the auto-radio installation.
• Ask your jobber for latest catalog, and check over our auto-radio condenser line. Or write us direct for a copy.



Order your copy NOW—the only

P. A. HANDBOOK

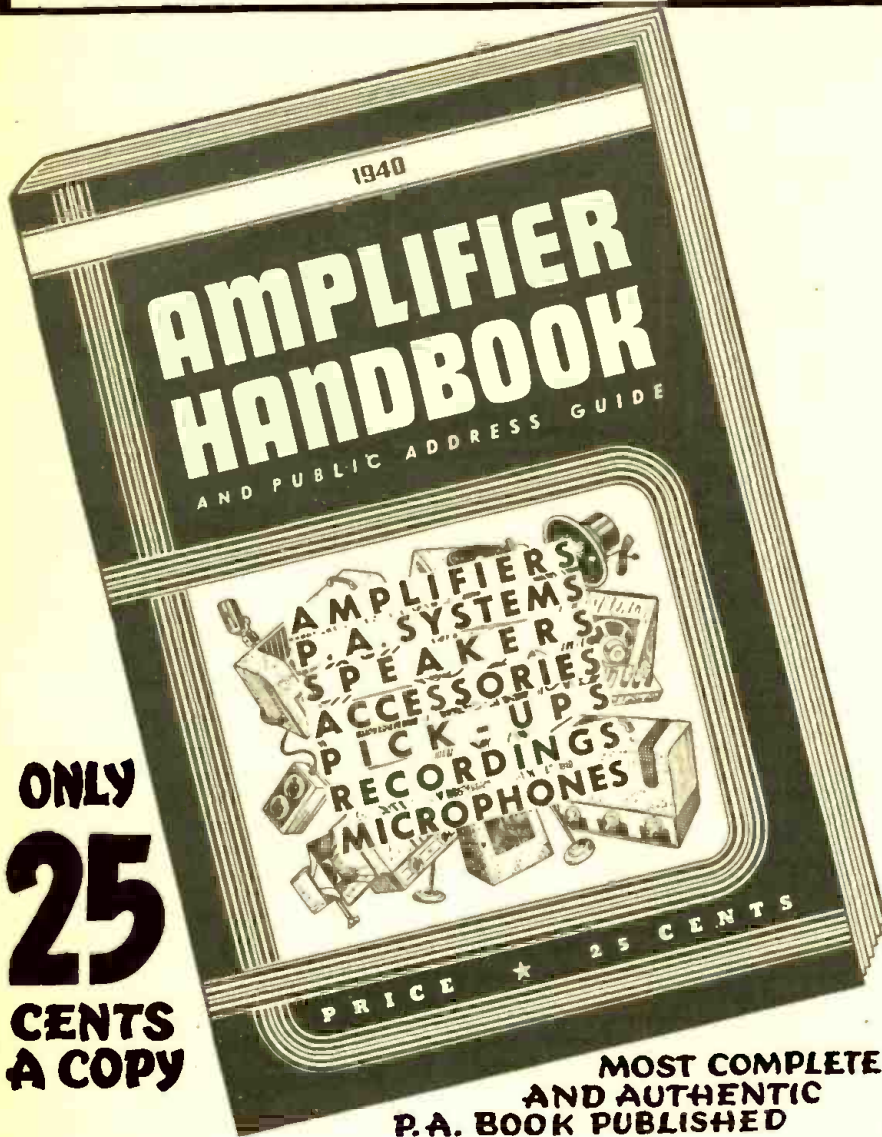

ONLY
25
CENTS
A COPY

THAT no book has yet been published which covers amplifiers and sound systems (also kindred systems) in one complete, authentic volume is almost unbelievable. Yet, it is a fact, there is no book in print which covers Public Address from A to Z. To bridge this wide-spread gap, RADIO-CRAFT has published a complete, magnificent volume on Public Address of such magnitude—so complete and authoritative—that every man engaged in radio can have both a theoretical and practical knowledge of the function and operation of sound systems. The editorial pages are so filled with instruction and replete with illustrations that the volume fully justifies its title of 1940 AMPLIFIER HANDBOOK AND PUBLIC ADDRESS GUIDE. This great HANDBOOK on Public Address should be read and studied by those who consistently build, service and sell sound equipment.

A MATCHLESS VOLUME
As complete as you would expect to find any engineering handbook—this is how the radio or P. A. man finds the AMPLIFIER HANDBOOK AND PUBLIC ADDRESS GUIDE. With essential technical data compiled from an exceptionally large number of sources, the volume covers nearly a hundred different subjects coordinating every conceivable branch or sub-division of Public Address.

THE CONTENTS
To actually show the scope and magnitude of the AMPLIFIER HANDBOOK AND PUBLIC ADDRESS GUIDE, an analysis of the contents is found at the right, showing the breakdown of the material featured within each particular section. A thorough reading of the contents shows the completeness of this book.

RADCRAFT PUBLICATIONS ■ 20 VESEY STREET ■ NEW YORK, N. Y.

RADCRAFT PUBLICATIONS, INC. ★ 20 VESEY STREET ★ NEW YORK, N. Y.

RC-1041

Gentlemen: Enclosed find my remittance of 25c for which send me POSTPAID, one copy of your NEW—1940 AMPLIFIER HANDBOOK AND PUBLIC ADDRESS GUIDE.

Send me others, for friends, also POSTPAID @ 25c each.

Name Address

City State

Remit by check or money order; register letter if you send cash or unused U.S. Postage Stamps.

A Resume of the Contents of the AMPLIFIER HANDBOOK AND PUBLIC ADDRESS GUIDE

FOREWORD

INTRODUCTION

Definitions—decibels, frequency, input, output, impedance, etc.

SECTION I—SOURCE

Carbon microphones (single-button and double-button)

Condenser microphones

Velocity (ribbon) microphones

Dynamic microphones

Crystal microphones (sound-cell types, crystal diaphragm types)

Cardioid microphones

Contact microphones

Phonograph pickups (magnetic types, crystal types)

SECTION II—AMPLIFIERS

Voltage Amplification

Design of resistance-coupled voltage amplifiers

Commercial voltage amplifier

The Power Stage

Class A amplifiers

Class AB amplifiers

Class AB₁ amplifiers

Class AB₂ amplifiers

Class B amplifiers

When to apply class A, AB, and B amplification

Power Supplies

Half-wave rectification

Full-wave rectification

Voltage doublers

Filter Circuits

Power supply regulation, etc.

Practical Hints on Amplifier Construction

Microphonism

Placement of components

Tone compensation

Inverse feedback

Remote control methods

SECTION III—DISTRIBUTION

The Loudspeaker

Dynamic speakers

Speaker performance (frequency response, efficiency)

High-fidelity speakers

Speaker Baffles and Housings

Outdoor speaker installations

Power cone speakers

Radial (360° distribution) speaker baffles

SECTION IV—COORDINATION

Input impedance matching

Matching speakers to P.A. installations

Phasing speakers

Effect of mismatching speakers to amplifier output

A typical P.A. installation (in a skating rink)

SECTION V—USEFUL PUBLIC ADDRESS DATA AND INFORMATION

Speaker matching technique

The ABC of Db., VU, Mu, Gm and Sm

Charts and formulas useful to the practical P.A. sound man

Handy index to important articles on public address and sound

Order Your Copy NOW—

Clip Coupon and
Mail Today!

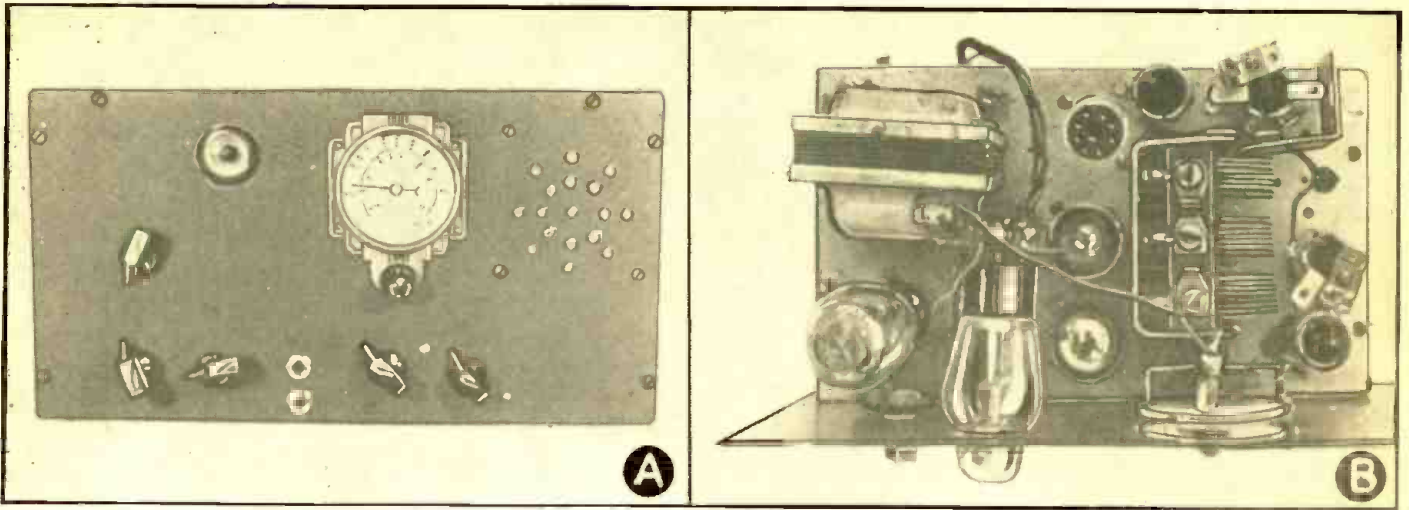

A.—The completed 14-W. Audio Amplifier and its associated equipment. Together they constitute an easily-duplicated sound system. B.—Close-up of the completed amplifier. The controls read, from left to right: Microphone, Microphone, Record, Radio, Bass, Treble.

14-WATT P. A. AND RECORDING AMPLIFIER

BRUCE BROYLES

A sound engineer of Berkeley, Calif., tells how RADIO-CRAFT readers can duplicate his 7-tube medium-power audio amplifier. He has used it at small club meetings, dances and fairly large outdoor gatherings. It is also suitable as the nucleus of a sound recorder.

A HIGHLY satisfactory amplifier for regular public address work or professional recording is the one that the writer has just recently completed. It worked so satisfactorily that it was thought others might be interested in building it.

CIRCUIT

The amplifier has 7 tubes, consisting of two 6J7GTs, two 6N7Gs, two 6V6GTs in the output and an 80 for a rectifier. An 80 rectifier was used as it is reasonable in price and also a very rugged tube. It has 4 inputs: 2 for microphones, one for a radio, and the other for the phonograph. Each has individual volume controls. The tuner input may be used for an additional phonograph, if required. Both a high or treble booster and a bass booster are part of the regular circuit. This unusually flexible system will deliver 14 watts of high-quality audio to the heavy-duty universal output transformer.

The circuit is quite well filtered, and with very little shielding an amplifier with no audible hum is obtained. The front panel

with the 6 controls give it a very professional appearance.

In the rear of the chassis, I have 3 speaker sockets. One is for the use of only 1 speaker and the other 2 are in parallel so that 2 speakers may be used at the same time.

Various makes of parts were used, as they were the ones the writer had on hand. Any nationally-known parts are reliable and whenever possible new condensers should be used, as it will save you a lot of trouble from breakdown of your amplifier later. And these things usually happen at very inopportune times.

Of course all the leads from each input to each control were carefully shielded and the shielding was well grounded. I used an ohmmeter to make sure all my grounds were good and didn't have any high-resistance connections to the chassis. It was found that it was quite necessary to shield the isolation resistors (500,000 ohms) that connect to the arms of the 2 mike controls, phone and tuner controls.

After the wiring is completed, put the tubes in the sockets, connect one speaker,

plug in the phonograph and turn on. Voltages should be checked to be sure tubes are operating at correct voltage. The bias condenser on the 6V6s should be used as it serves to equalize the stage if one tube is weaker than the other.

LIST OF PARTS

RESISTORS

- Two I.R.C., 1 meg., R1, R22;
- Two I.R.C., 2 megs., R4, R25;
- Four I.R.C., 0.25-meg., R3, R18, R19, R24;
- Five I.R.C., 50,000 ohms, R6, R9, R15, R17, R26;
- Four I.R.C., 0.5-meg., R5, R27, R29, R31;
- Two I.R.C., 2,000 ohms, R23, R2;
- Three I.R.C., 0.1-meg., R8, R14, R16;
- One I.R.C., 5,000 ohms, R11;
- Three I.R.C., 1,000 ohms, R7, R13, R21;
- One I.R.C., 150,000 ohms, R20;
- One Ohmite, 200 ohms, 10 W., R32;
- Four Mallory volume controls, V-1000 MP, 1 meg., R33, R34, R28, R30;

(Continued on page 254)

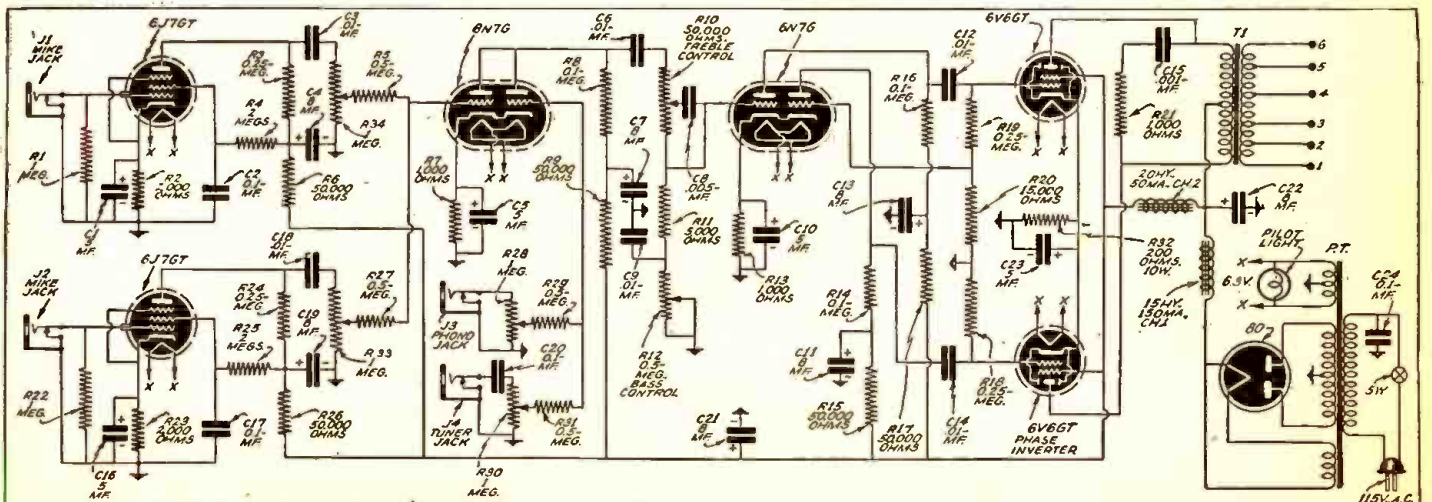

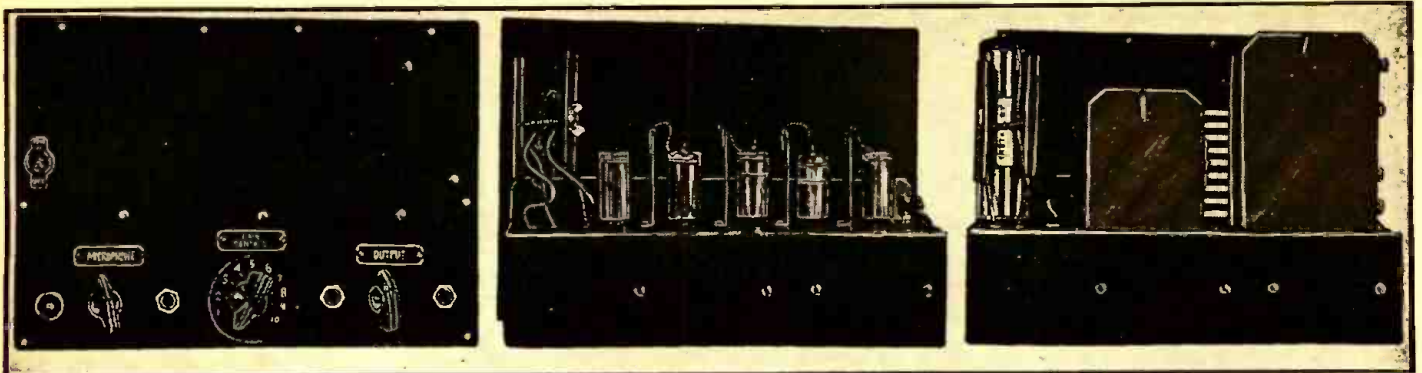

The front view of the completed high-gain Battery Power-Amplifier shown at "A"; "B", rear view with batteries and battery holders removed; "C", rear view with batteries in place. The amplifier complete with front panel measures 7 x 10 x 3 3/4 ins. deep.

HIGH-GAIN BATTERY-POWERED AMPLIFIER

Using the Tiny 1-4 Volt Battery Tubes

Miniature tubes designed originally for hearing-aids also have application in other equipment, as, for example, the general-purpose small-space "feather"-weight Battery-type Power Amplifier here described. Design, construction, test and application are discussed by Mr. Baptiste.

GEO. F. BAPTISTE

HERE is a practical Miniature-Tube Amplifier. Of the high-gain type, it possesses many possibilities. The amplifier is entirely self-contained and lightweight, weighing only 6 1/2 lbs. complete with all necessary batteries. Its size is 7x10x3 3/4 ins. deep. It utilizes 5 tubes of the new miniature type as well as miniature "B"- and "A"-batteries.

Some of the varied uses of such an amplifier are: portable preamplifier, hearing-aid amplifier, dictaphone work, sound-level noise detection, fixed sound detection in various institutions where hearing-aid equipment is desired for people who are exceptionally hard-of-hearing, inter-office communication by the use of 2 or more such amplifiers, as well as many other uses that one could go on talking about indefinitely. When used as a preamplifier, this amplifier can be equipped with an output transformer to match various input impedances.

FEATURES

The outstanding feature of this high-gain amplifier lies in the use of low-drain tubes drawing exceptionally low "A" and "B" current. The total "A" current is 300 milliamperes; the total "B" current is 2 ma.,

with the values shown in the schematic diagram, Fig. 1. A single 67 1/2 V. "B" battery, such as the Eveready type 467, or the Burgess XX45 is all that is necessary for this amplifier. However one can change the "B" battery voltage to suit his own requirement. For 45-volt operation the gain-percentage is 30; for 67 1/2 volts, 40; and for 90 V., 50 per stage. The voltage chosen for this amplifier was 67 1/2, giving a total gain of around 85 db.

Any type of microphone, such as a crystal, velocity, or dynamic of either the high- or low-impedance type may be used. When using a low-impedance type it is only necessary to use an Amperite type LGP input transformer, plugging same into the high-impedance jack on the amplifier front panel.

A separate jack is provided for the use of a carbon microphone. There are in addition 2 output jacks for the use of crystal or magnetic earphones; and the circuit is adapted to each simply by flipping the toggle switch placed between the 2 jacks. A small 2-in. P.M. speaker can be plugged into the (magnetic) phone jack provided it has a 2,000-ohm-impedance output transformer.

The use of 3 high-gain Cascade stages

of A.F. amplification using 1S5 pentodes, followed by an output stage of two 1S4s in parallel, provides ample output for the phones or speaker. See Fig. 1A for various values of output load if more output is desired for special purposes.

Tube shielding baffles are used throughout, as well as individual tube shields, thus preventing any possible feedback from one stage to the other. The layout of components is such that all connections are as short as possible.

CONSTRUCTION

In the construction of any high-gain amplifier, the choice of the best parts possible to obtain should be used throughout, and all grid as well as plate leads should be as short as possible. Figure 2 shows the front panel layout for mounting the various jacks, switches, and master gain control. These should be mounted as shown, and are located as follows:

The gain control is in the middle of the panel near the bottom, with the microphone inputs to the left and the microphone switch in the center of the 2 jacks; this brings the connection directly under and near the input tube sockets. The output is to the right

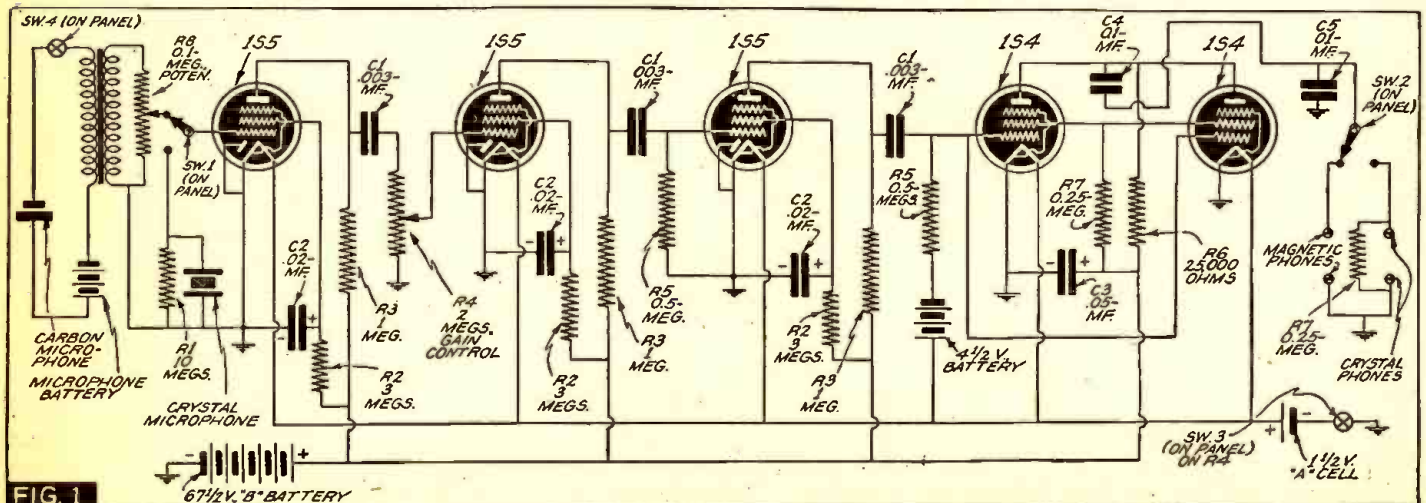

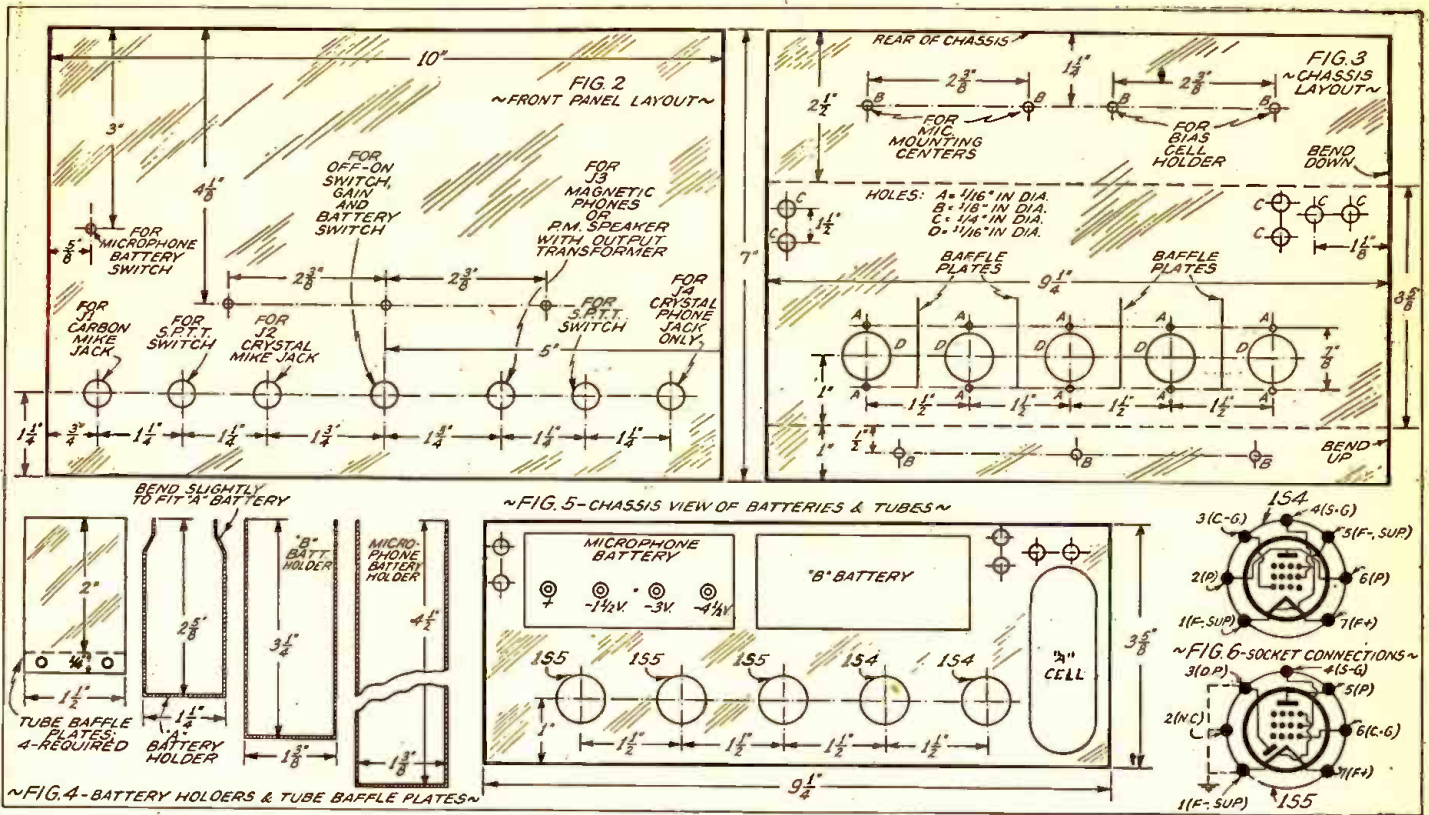

of the gain control, with output switch in the center of the 2 phone jacks. This allows a change to either by the flip of the switch, and also makes the same connections near the tube, and the output tubes under the chassis.

Figure 3 shows the chassis layout and is self-explanatory. There are tube baffles mounted in between the various tubes, as explained. This prevents any possible feedback that otherwise might occur, and works out nicely. See Fig. 4 for the correct tube baffle plate size. Before mounting these it is best to mount the tube sockets. Have the sockets with tube pins Nos. 1 and 7 facing the rear of the chassis and mount the tube sockets with rubber grommets between the chassis and the sockets. This cushions the sockets and prevents a microphonic condition.

The chassis is about 1 inch less wide than the front panel. The sizes of the various holes for bolting and mounting the tube sockets are all shown in Fig. 2. The chassis is 2½ ins. deep, and is bent down at right angles; the other side is bent upwards, and then bolted to the front panel.

Figure 4 shows the battery holders. These are for the "A" and "B" batteries and the microphone battery as well. The various battery wires feed through the chassis, with rubber grommets in the chassis to prevent any possible shorting of the wires. Figure 5 shows the tubes and batteries as the "spot", on the chassis. The chassis and the front panel are made of an easily-workable alloy known as Electraloy. For the battery holders, a bolt is used with a wing nut to clamp the battery firmly in place.

Figure 6 gives the complete tube layout as viewed from the bottom of the chassis, and should assist greatly in wiring the amplifier.

DIAGRAM

Figure 1 shows the complete schematic diagram.

This circuit shows a parallel output for 2 tubes. Of course this can be changed to suit individual needs. Figure 1A gives data for the various load resistances to produce various output levels; the lower the value

of the output load, the higher will be the output. Of course, as the value of this resistance is increased the lower will be the output level. In this manner the circuit may be adjusted to meet different requirements. There is also a diagram of an output transformer and this can be used if desired, simply by eliminating the output load resistors in the plate and screen-grid of the 1S4 output tubes, and a permanent-magnet (P.M.) speaker can be used; or, the output can be matched to any line impedance as needed.

A push-pull arrangement can be obtained, by using a type 1S4 as a driver and then using 2 type 1S4 tubes as the output types, with a transformer to match. All other parts are mounted under the chassis, with the transformer for the carbon microphone mounted directly under the input tube, on the rear of the chassis pan.

BIAS-CELL DATA

It may be well to describe the biasing consideration of miniature tubes in a high-gain amplifier of this type, and the methods used.

On the type 1S5 the tubes are operated at zero bias, this voltage being obtained from the chassis by connecting the "A" and "B" minus leads to the chassis, and connecting the grid-returns of the type 1S5 to the chassis, or the negative filament lead (which is returned to the chassis, also).

The type 1S4 miniature tubes require a bias of 4½ volts, and this is obtained from Mallory-type bias-cells, thereby doing away with the use of a "C" battery. A 4-cell holder is used, and 2 bias-cells of the 1-volt type are used along with 2 more bias-cells of the 1½ V. type making a total of 4½ V. The negative lead of the bias-cells goes to the 0.5-meg. grid-return resistor in the 1S4 grid-return circuit; the positive lead connects to the positive filament leg. This voltage from the bias-cell cannot be measured with an ordinary voltmeter but requires one of the high-resistance type, or a test instrument of the Voltohmyst type; in other words, a meter that will not draw any current from the circuit under test.

This also goes for the measurement of the "B" battery voltage at the tube sockets, since here, too, the circuit is of quite high resistance.

These bias-cells last permanently and do not need replacement.

If a low-resistance voltmeter is used to measure the plate and screen-grid voltage, there will be practically no voltage reading, but such is not the case. By using the type meter previously mentioned it will be found that a different condition exists.

In the use of crystal earphones on the miniature-tube amplifier, it was found necessary to install an added bypass condenser, C5, in the output circuit. This was due to the fact that the sensitivity of the crystal phones would cause a slight amount of feedback in the output circuit—this is not the case with magnetic phones—installing a 0.01-mf. tubular condenser from the output blocking condenser to ground overcame this frequency discrimination or feedback.

CARBON MICROPHONE LEVEL DATA

In the use of a carbon microphone with a high-gain amplifier the output of the carbon microphone is too high. Some means therefore must be used to reduce the gain to suit the capacity of the amplifier to handle the voltage fed to it. The microphone used with this amplifier is a single-button type, but a double-button unit may be used if better fidelity is desired. To overcome the problem of high-level mike output a volume control is shunted across the secondary of the microphone transformer, with the arm of the potentiometer going to the control-grid of the 1S5 input tube switch. See circuit.

When the amplifier is placed in operation the volume control is adjusted at the correct level as determined by listening to the output. Once set, it is left at that position. This explains why the volume control is mounted under the chassis, as previously noted. The amplifier is then controlled by the master gain control, thereby eliminating 1 control. A potential of 3 V. (preferable voltage) is fed to the carbon microphone; at this voltage the microphone current will be 5 ma.,

FIX ANY RADIO

Amazing New Invention

Simplified Radio Servicing by Comparison Method

Learn to repair radios in minutes instead of hours. Revolutionary technique permits you to do expert work almost immediately. Most repairs can be made without test equipment or with only volt-ohm-meter. Simple point-to-point circuit suggestions locate faults instantly.

Complete \$1 Training

FOR RADIO SERVICEMEN

Find any radio fault with ease. Follow the comparison tests given on 16 large trouble-shooting blueprints. Over 1,000 practical repair hints. Hundreds of simplified tests using a 5c resistor and a filter condenser. Covers every radio set—new and old. Introductory material included for beginners and to serve as a review for experienced radio men. Also several chapters on test equipment. Entire plan is stark new and will change servicing methods. Developed by M. N. Beitman, radio engineer, author, and teacher.

RESULTS, SATISFACTION GUARANTEED

Take advantage of our "no-risk" free trial. Use this time-saving, money-making radio servicing method for 10 days without any obligations. See how much time you will save every day on every radio job. Learn new short-cuts in radio servicing. Find out how to use your testers for faster and better repairs. Then decide to keep Comparison Method Manual or return it and receive a refund in full. You cannot lose—but you owe yourself a chance to look at this plan.

NEW 1941 EDITION

The complete simplified training is yours for only \$1.00, full price. It will more than pay for itself on the first radio job. Examine and use this new plan for 10 days at our risk. Send "no-risk" order coupon right now. Use the plan this week.



In manual form. Size 8 1/2 x 11 in. Entire plan U.S. Copyrighted.

NO-RISK TRIAL ORDER COUPON SUPREME PUBLICATIONS

328 S. Jefferson St., CHICAGO, ILL.

Ship the new manual, "Simplified Radio Servicing by Comparison Method," for examination. I am enclosing \$1.00, the full price, and 10c for postage. I must be satisfied or you guarantee to refund my remittance.

Name: RC-O-S

Address:

DATAPRINTS



TESLA-LOUDIN COILS

- 20c Ea. in order for 10 (Data and Drawings only.)
- 36" Sp'k Tesla-Oudin Coil 40c (1 K.W. Exc. Trf. Data incl.)
- 8" Sp'k Tesla-Oudin Coil 40c (1/4 K.W. Exc. Trf. Data incl.)
- 8" Sp'k Oudin; 110 Vt. "Kick Coil" type.....40c
- 3" Tesla Works on Ford Coil.....40c
- 1" Sp'k Vibrator Hi-Freq. Coil 40c

NEW! 5 ft. Sp'k. Oudin Coil & Exciter Data75c



Induction PIPE & ORE LOCATOR

Induction Type, Data40c
Radio Type40c

More DATAPRINTS 40c each!

- | | |
|--------------------------|-------------------------|
| 5 Meter Superhet. | Electric Refrigerator |
| 1/2 Meter Tr. & Rec. | Wheatstone Bridge |
| 20 A.C. Probs. & Ans. | Weld. Transf. 2 K.W. |
| 20 Telephone Hook-ups | Rewinding Armatures |
| 100 Mech. Movements | String Galvanometer |
| 20 Motor Hook-ups | 20 Simple Bell Circuits |
| Television Hook-up | Steel Wire Recorder! |
| 20 Elec. Party Tricks | Water Wheels |
| Solenoids and Magnets | Water Turbines |
| —get list. | Photo Cell and Relay |
| Fry Eggs on Ice! | Ring 4 bells: 2 Wires |
| Experimental Photophone | 20 Tesla Tricks |
| Radio Control for Models | Polarized Relay |
| Diathermy Apparatus | Induction Balance |
| Inductor Organ | Electric Pipe Thawer |

Special Prices: 4 prints \$1.00; 10 for \$2.00; Single, 40c each. Get New Catalog 100 A.

The DATAPRINT Co.
Lock Box 322D, Ramsey, N. J.

while at 4 1/2 V. it will be 10 ma. The crystal microphone can be any type with medium output level.

LIST OF PARTS

- RESISTORS**
One I.R.C., 10 meg., 1/2-W., R1;
Three I.R.C., 3 meg., 1/2-W., R2;
Three I.R.C., 1 meg., 1/2-W., R3;
One I.R.C. (with switch Sw. 3), 2 meg., 1/2-W., R4;
One I.R.C., 0.5-meg., 1/2-W., R5;
One I.R.C., 25,000 ohms, 1/2-W., R6;
Two I.R.C., 0.25-meg., 1/2-W., R7;
One C.R.L., 0.1-meg.; CRL midget volume control (under chassis), R8.

CONDENSERS

- Three Sprague 0.02-mf., 400 V., C2;
Three Sprague 0.003-mf., 400 V., C1;
One Sprague 0.05-mf., 400 V., C3;
One Sprague 0.1-mf., 400 V., C4.

SWITCHES

- Two Centralab, Part No. 1460, 1-pole, 2-position Sw. 1, Sw. 2;
One Snap Switch, S.-P., D.-T., with OFF and ON plate, Sw. 4.

TUBES

- Three RCA Type 1S5;
Two RCA Type 1S4.

BATTERIES

- One Burgess Type XX45. Miniature "B", 67 1/2 V.;
One Burgess Type 2370, "C", for microphone, 4 1/2 V.;
One Burgess Type 2FBP, "A", for filament, 1 1/2 V.

MISCELLANEOUS

- One 4-cell bias holder;
Two Mallory bias-cells, 1 V.;
Two Mallory bias-cells, 1 1/4 V.;
One Amphenol Type PCIM jack and plug, complete, for carbon microphone;
One United Transformer Corp. transformer, Part No. 35, for carbon mike, T1;
Two 7 x 10 in. Electroloy panels;
One Yaxley dial plate with markings 1 to 10 and marked OFF position;
One Oxford 2-in. P.M. speaker if desired, output transformer to match, 8,000-ohm load to voice coil;
Nuts, bolts, washers, grommets, terminal strips, wire, solder, marked dial, etched plate for phones, microphones, etc.;
Five Amphenol miniature-tube sockets, wafer type.

WORRIES OF THE F.C.C.

A New York resident suggests that in connection with its telephone inquiry the Commission determine if the rate for the initial call could be made to apply for 5 minutes instead of the present 3-minute limitation.

From Brooklyn, N. Y., comes suggestion that a special telephone rate be made available to persons in the military service. The Commission advises that, while sympathetic to the motivating spirit, the Communications Act says in Section 202 (a):

"It shall be unlawful for any common carrier to make any unjust or unreasonable discrimination in charges, practices, classifications, regulations, facilities, or services for or in connection with like communication service, directly or indirectly, by any means or device, or to make or give any undue or unreasonable preference or advantage to any particular person, class of persons, or locality, or to subject any particular person, class of persons, or locality to any undue or unreasonable prejudice or disadvantage."

FREE- REAL ELECTROPLATING OUTFIT



Now —
You Can ELECTROPLATE
EASILY WITH A BRUSH

SOMETHING new for radio men—something which gives you the opportunity to make additional profits—or to improve your type of service. Here's an ELECTROPLATING KIT amazingly simple to operate—you just Electroplate with a Brush!

NOT A TOY!

Electroplate for profit, hundreds of things in the household—ashtrays, fixtures, water faucets, worn brackets, door knobs, musical instruments, jewelry and silverware and other articles. It's an indispensable piece of equipment—plate articles in hotels, apartments, office buildings, medical and dental offices, factories, schools, laboratories, etc. Exactly the same outfit (but larger) is used professionally by electricians, radio service men, automobile repair shops, etc. Requires one single dry cell 1 1/2-volt battery to operate.

You can electroplate tarnished receiver parts, switches, contacts, worn radio parts and accessories and dianaly chassis. Put this REAL ELECTROPLATING KIT to use immediately—make it the most useful article in your shop or laboratory. And you can get it absolutely FREE (except for slight mailing cost).

Subscribe today to RADIO-CRAFT for One Year (12 issues) and receive absolutely FREE this ELECTROPLATING KIT. New subscribers are accepted or extend your present subscription twelve months. Mail remittance of \$2.00 (plus 10c for shipping charge on kit) to the publishers. (Canada and foreign \$2.85). You will receive your FREE REAL ELECTROPLATING OUTFIT by return mail. Use coupon below to enter subscription.

RADIO-CRAFT

20 Vesey Street New York, N. Y.

RADIO-CRAFT RC-1041
20 Vesey Street, New York, N. Y.

Gentlemen: Enclosed find my remittance of \$2.00 for which enter my subscription to RADIO-CRAFT for One Year (12 Issues). Send me FREE ELECTROPLATING OUTFIT (Canada and foreign \$2.85) in U. S. add 10c additional to cover shipping charges on kit.

New Subscriber Extend Present Subscription

Name

Address

City State

(Send remittance by check, money order or unused U. S. Postage stamps. Register letter if you send cash or stamps.)

F. M. SERVICE

Entirely new problems daily face radio Servicemen called upon to install and maintain Frequency Modulation receivers. A well-known radio technician calls upon his wealth of practical experience to here present the answers to many of these servicing puzzlers. The initial article presented practical information on F.M. signal pick-up problems; Part II, presented here, deals with actual F.M. receiver servicing.

BERTRAM M. FREED

PART II.

Alignment and Diagnosis

IN servicing Frequency Modulation receivers, knowledge of the fundamental operating differences between Amplitude Modulation and Frequency Modulation receivers is essential. The subject of *F.M. antenna and installation* was covered as completely as space limitations would permit, in Part I of this discussion on F.M. Installation and Service. It is the purpose of this article (Part II) to discuss *F.M. receiver service requirements and procedures*. We will start off with a brief résumé of *First Principles* and then launch into our discussion of practical F.M.-receiver servicing. (See "List of F.M. Articles in *Radio-Craft*" at the end of this article.—Editor)

Frequency-modulated signals are obtained by varying the frequency of the carrier signal at an audio or sound frequency rate. The amount the carrier frequency is varied on both sides of the mean or carrier frequency determines the intensity or volume level of the signal. Basically, the F.M. receiver is similar to the A.M. superheterodyne receiver except for 3 major differences. This may be seen in the block diagram of the 2 receiver types pictured in Fig. 1. Both types may have an R.F. stage, the primary intention of which is to provide adequate selectivity and voltage gain. A converter stage, consisting of a single tube functioning as mixer and oscillator, or 2 separate tubes performing these functions is common to both.

THE I.F. AMPLIFIER

Although an I.F. amplifier of one or more stages is also common to each receiver, the I.F. amplifier in an F.M. receiver differs from that of an A.M. receiver by reason of its wide-band characteristics. In an A.M. receiver, the I.F. amplifier is designed to reject a signal more than 10 kc. to 15 kc. from that to which the amplifier is tuned. On the other hand, the I.F. amplifier in an F.M. receiver is designed to pass a signal, without appreciable attenuation, as much as 100 kc. either side of the frequency to which the I.F. transformers are aligned.

Various means are utilized to secure this band-width. In some instances, the primary and secondary windings are over-coupled to broaden-out the response curve. The General Electric HM 136 receiver and the more recent Pilot FM-12 receivers are examples of this practice.

The majority of F.M. receivers, however, employ shunt resistors, to load up either or both the primary and secondary windings to obtain the required 150 kc. to 200 kc. band-width. The use of such high-gain tubes as the 1852, 1853, 7G7, and 7V7, more than offsets the loss in gain as a result of resistive loading. In the early Pilot FM-12 model, as well as several F.M. adapters,

both primary and secondary of the I.F. transformers are shunted by resistors, as shown in Fig. 2. Only the secondary winding of the I.F. transformers in almost all Stromberg-Carlson F.M. receivers, is shunted resistively. The value of these shunt resistors varies with each receiver model, and depends upon transformer design and degree of loading required in each case to secure the band-spread. Resistor values from 10,000 ohms to 50,000 ohms are most commonly used for this purpose.

Early-model F.M. receivers employed an I.F. amplifier tuned to 2.1 megacycles, with a few using 3 mc. Modern F.M. receivers have I.F. amplifiers aligned to 4.3 mc., the standard set down by the Radio Manufacturers Association (R.M.A.). One model manufactured by Zenith has an 8.6 mc. I.F. amplifier.

THE LIMITER

In the block diagram for an F.M. receiver, a limiter stage may be seen. The limiter stage, essentially an I.F. stage, consists of 1 or 2 amplifier tubes so arranged as to deliver constant output despite wide variations in signal input. The tubes employed as limiters are usually pentodes having sharp cut-off characteristics, and operated at low plate and screen-voltages, so that plate current cut-off occurs with relatively small grid bias or signal input.

Normal signal input will swing the grid voltage considerably above and below the linear portion of the tube's characteristic curve. Positive peaks beyond the range of the limiter tube will be clipped by grid-bias limiting, whereas negative signal peaks will be clipped due to plate current cut-off. In this way, variations in signal voltage delivered to the limiter which are greater than the operating limits of the tube are clipped and have no effect upon plate current.

Since static and noise disturbances, primarily, produce amplitude changes in the signal, as do tube noises, the clipping of the amplitude changes removes the disturbing effects but leaves the frequency-modulated signal unaltered. This action is illustrated at Fig. 3. For complete noise-elimination, it is essential that the signal voltage appearing at the limiter grid be sufficiently great to swing the grid bias to plate current cut-off and saturation points.

Limiter tubes are generally operated at zero bias or with a small bias voltage. The limiter circuit utilized by Stromberg-Carlson, shown at Fig. 4, is representative of many F.M. receivers. The circuit of the General Electric H.M. 136 receiver, at Fig. 5, typifies another method wherein the load resistance is connected in the secondary-return. In this case, the tube is supplied with a small initial negative bias. In

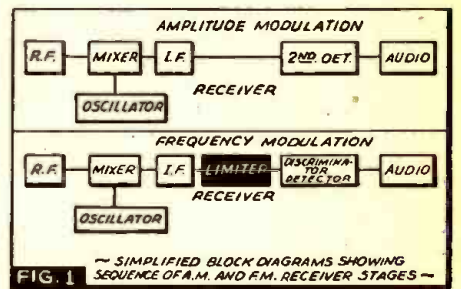

FIG. 1 — SIMPLIFIED BLOCK DIAGRAMS SHOWING SEQUENCE OF A.M. AND F.M. RECEIVER STAGES —

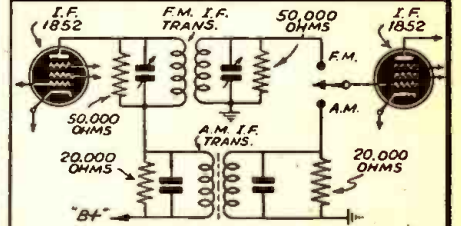

FIG. 2 — USE OF RESISTIVE LOADING TO BROADEN RESPONSE CHARACTERISTICS. PILOT FM 12 —

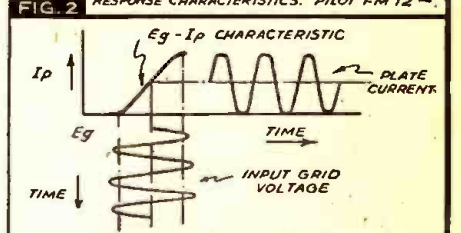

FIG. 3 — ACTION OF LIMITER IN CLIPPING MODULATION PEAKS BEYOND LINEAR PORTION OF CHARACTERISTIC —

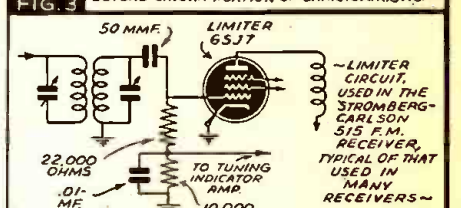

FIG. 4 — LIMITER CIRCUIT, USED IN THE STROMBERG-CARLSON 515 F.M. RECEIVER, TYPICAL OF THAT USED IN MANY RECEIVERS —

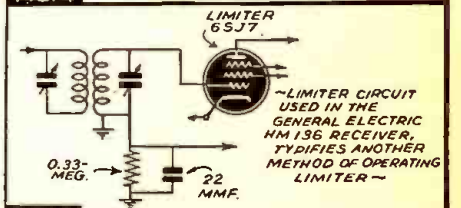

FIG. 5 — LIMITER CIRCUIT USED IN THE GENERAL ELECTRIC HM 136 RECEIVER, ILLUSTRATING ANOTHER METHOD OF OPERATING LIMITER —

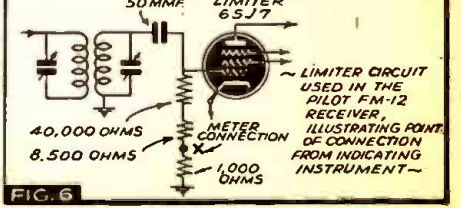

FIG. 6 — LIMITER CIRCUIT USED IN THE PILOT FM-12 RECEIVER, ILLUSTRATING POINT OF CONNECTION FROM INDICATING INSTRUMENT —

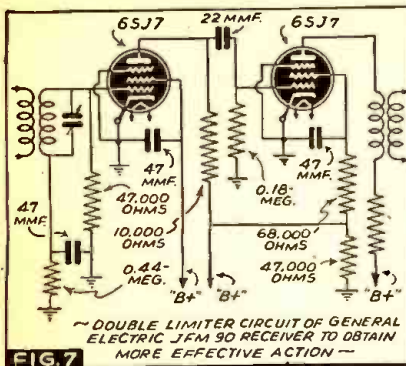

FIG. 7

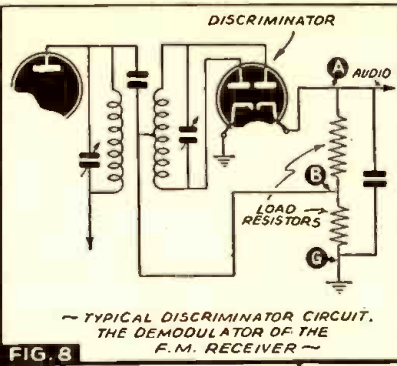

FIG. 8

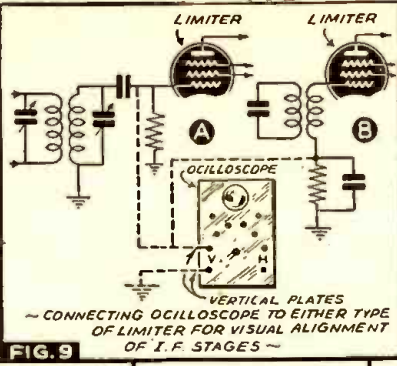

FIG. 9

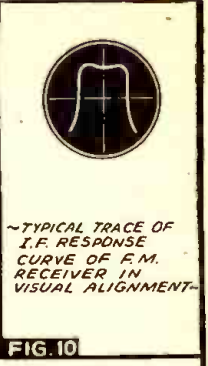

FIG. 10

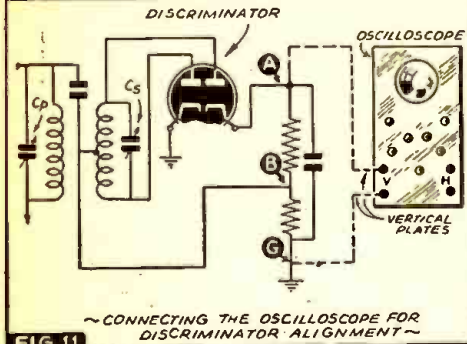

FIG. 11

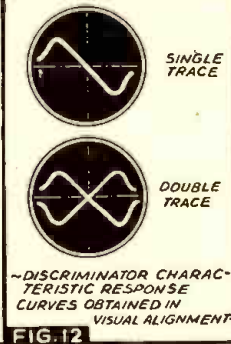

FIG. 12

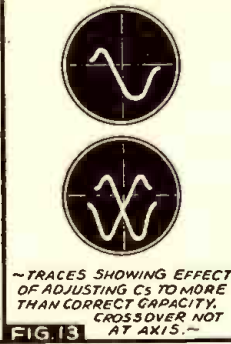

FIG. 13

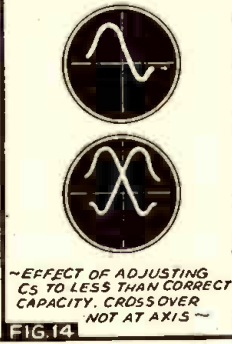

FIG. 14

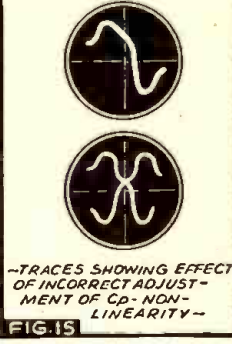

FIG. 15

the Pilot FM-12 receiver, a low-value resistor is connected in series with the limiter load resistor shown at Fig. 6, so that an indicating meter may be conveniently connected to the receiver for alignment purposes. An example of 2 tubes arranged in cascade or series to operate as more effective limiters is seen in the General Electric JFM 90 receiver, whose limiter circuit is shown at Fig. 7.

THE DISCRIMINATOR

The 3rd major point of difference between an A.M. and F.M. receiver lies with the type of 2nd-detector or demodulator. In the F.M. receiver, a discriminator detector, as shown in Fig. 8, is used. The discriminator consists of a push-pull diode detector in which opposing voltages developed across load resistors are equal and opposite so long as the carrier frequency rests at the intermediate frequency. The resultant voltage across the 2 load resistors, from point A to ground is zero, and no audio voltage is developed.

When the signal impressed upon the discriminator transformer is frequency modulated, due to phase changes as a result of both magnetic and capacity coupling, the voltage drops across the load resistors will be unequal as the frequency varies above and below the intermediate frequency with modulation. The resultant voltage measured across both diode load resistors will then be equal to the difference between the voltages developed across each; and will vary in polarity from point A to ground as the modulation swings the frequency higher and lower than the resting or resonant frequency. The degree of modulation, or frequency swing, determines the magnitude of the voltage; and, the number of times per second, or rate at which the I.F. signal swings above and below the resonant frequency, produces the audio signal.

Further technical discussion on limiter and discriminator operation is beyond the scope of this article, and the reader is referred to past issues of *Radio-Craft* for more detailed information. (See appended "List of F.M. Articles."—Editor)

NEED FOR ALIGNMENT

Although most common troubles encountered with A.M. receivers, such as faulty condensers and resistors, are not foreign to F.M. receivers, and are located in like

manner, probably the major difficulty with F.M. receivers is that of alignment. In an A.M. receiver, the result of I.F. stages only slightly misaligned is a loss in sensitivity and selectivity.

The result of misalignment in an F.M. receiver is much more apparent and serious, for unless the I.F. stages and discriminator are accurately aligned, not only will loss in sensitivity be experienced, but also the symptoms of distortion and noisy reception will be encountered. The need for precise alignment of the I.F. and discriminator stages cannot be overemphasized. Despite statements to the contrary, new receivers often require realignment, due to changes occurring in shipment and delivery, where adjustment trimmers or circuit leads shift sufficiently to influence alignment. This is so, notwithstanding precautions taken by designers to avoid, by careful packing, bonding, and engineering, the possibility of changes. For this reason, the alignment of F.M. receivers should be thoroughly understood. *It must be remembered, however, that most new receivers reach their final destination in perfect condition, and the impression that all receivers must be realigned is not intended.* Before alignment is attempted, the symptoms displayed during receiver operation must warrant the need for the procedure. Noisy operation and distortion is not always the result of misalignment. More often, it is due to insufficient signal pick-up, the cause of which may be a faulty antenna system—faulty in the sense that the dipole may not resonate at the F.M. band or be properly oriented—transmission line mismatch to the dipole or receiver, or the use of a transmission line with high R.F. losses. This was discussed in some detail in Part I of this article. At any rate, there has been and will be need for alignment of the tuned circuits of F.M. receivers.

The procedure followed in F.M. receiver alignment is similar in many respects to that employed with A.M. receivers, but with several important differences. In A.M. receiver alignment, a low input signal is used to adjust tuned circuits to prevent excessive action of the automatic volume control (A.V.C.) and thereby circumvent the use of an output indicator. A strong signal is necessary to align F.M. receivers, a signal strong enough to saturate the limiter tube, since this condition is normal during regular operation. The output indicator is no longer

a copper-oxide rectifier type of A.C. meter connected to output plate or voice coil circuits.

There are 2 recognized methods of aligning the I.F. and discriminator stages of an F.M. receiver. One is through the use of a wide-band, frequency-modulated signal generator, and oscilloscope, which is called *visual* or *variable-frequency alignment*, a procedure employed by many manufacturers who claim that this is the only proper way to obtain perfect alignment. A second method, referred-to as *fixed-frequency alignment*, makes use of a signal generator and a sensitive milliammeter, such as is used in 20,000 and 10,000 ohms/volt voltmeter instruments.

Which alignment procedure is superior is not a question to be decided here. The advantages of visual alignment are well-known, but too few radio service shops or radio technicians are as yet equipped with the wide-band frequency modulator necessary for visual alignment on an oscilloscope. Besides, when receivers are serviced in the field, transporting equipment such as oscilloscopes and frequency modulators is inconvenient. However, either the variable-frequency or fixed-frequency method may be employed to effect good alignment, and for this reason both are described.

VISUAL ALIGNMENT

The vertical plates of the oscilloscope are connected to the "high" side of the limiter load resistor, as shown in Fig. 9, and the ground terminal is connected to ground or chassis of the receiver. The signal generator is connected to the control-grid of the 1st-detector or mixer, and ground, the same ground connection used for the oscilloscope. (In the General Electric F.M. adapter or receiver using 2 1st-detectors, the signal is fed into the 2nd mixer).

The wide-band frequency sweep oscillator may be incorporated within the signal generator or contained in the oscilloscope. In any case, the sweep oscillator is heterodyned with the signal generator *unmodulated* output to produce the specified intermediate frequency signal for the receiver under alignment. Use the widest sweep frequency that is possible with the equipment employed, since correct adjustment is simplified. In some signal generators and oscilloscopes, a sweep frequency as high as 750 kc. is available. In others, a sweep fre-

quency of only 200 kc. to 300 kc. is possible. When the frequency modulator is contained within the oscilloscope, synchronizing is no problem. Otherwise, a synchronizing voltage from the "wobulator" must be injected into the oscilloscope to obtain a steady pattern. Starting with the limiter input transformer, and proceeding back to the 1st I.F. transformer, adjust trimmers of each I.F. transformer to obtain a symmetrical response curve closely similar to that illustrated at Fig. 10.

In some receivers, a stage-by-stage or progressive alignment, rather than an overall alignment will produce better results. The frequency-modulated signal generator output is connected to the control-grid of the I.F. amplifier preceding the limiter and the limiter transformer is adjusted to obtain a curve with steep sides and wide peak. Each transformer is then adjusted after the signal generator connection is made to the control-grid of the tube preceding that transformer. These I.F. transformers should be adjusted to give maximum width consistent with maximum vertical deflection. No over-all adjustments are made after this stage-by-stage alignment is completed.

A dummy antenna, consisting of a 0.05-mf. or 0.1-mf. condenser, must be used in series with the "high" side of the signal generator and tube control-grid. When the generator is coupled to the grid of the mixer, insufficient output may result due to the low impedance of the R.F. coil in the mixer grid circuit. In this case, it may be necessary to temporarily disconnect the R.F. grid lead from the mixer control-grid, and couple the generator through the dummy antenna directly to the mixer. A resistor, from 10,000 to 25,000 ohms in value, must be connected from tube grid to ground to complete the grid circuit.

To align the discriminator, the oscilloscope is connected across the diode load resistors. The vertical plates are connected, as shown in Fig. 11, and the ground terminal to the ground or chassis of the receiver. Without altering or disturbing the frequency setting of the frequency-modulated signal generator, which is coupled to the control-grid of the mixer, adjust the primary and secondary trimmers of the discriminator transformer, referred to as C_p and C_s , to obtain the "S" or "X" trace on the screen of the oscilloscope as shown in Fig. 12.

The type of pattern depends upon whether single- or double-trace alignment is employed. It can be seen that the center part of the single trace is a straight line and is centered and symmetrical with respect to all axes. The double-trace discriminator characteristic must also be centered and symmetrical, as shown, with the crossover at the horizontal and vertical axes. When trimmer C_s (Fig. 11) is adjusted to more than correct capacity, the traces illustrated at Fig. 13 will be obtained. The traces shown at Fig. 14 picture the condition resulting when C_s is adjusted to less than correct capacity. The adjustment of trimmer C_p (Fig. 11) determines the linearity of the center portion of the trace, which must be straight. Incorrect alignment of C_p may provide a trace shown at Fig. 15. Since the adjustment of C_p and C_s inter-lock to some extent, it is usually necessary to readjust C_s again after C_p is aligned. When the "S" or "X" trace seen at Fig. 12 is obtained, the discriminator alignment is complete.

FIXED-FREQUENCY ALIGNMENT

Highly satisfactory and accurate alignment of the I.F. and discriminator stages of an F.M. receiver may be accomplished without a frequency modulator and oscilloscope. For this purpose, a calibrated

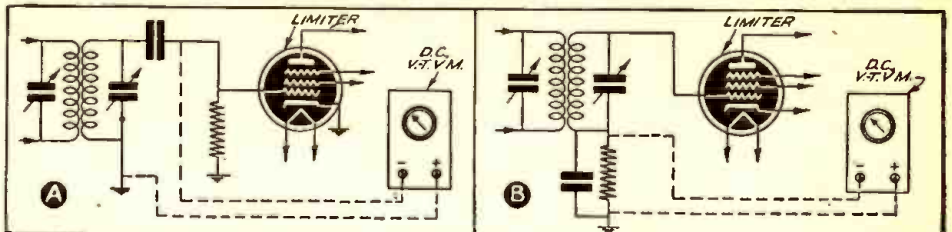

FIG. 17 ~CONNECTING A V.T.V.M. TO EITHER TYPE LIMITER CIRCUIT TO ALIGN I.F. STAGES~

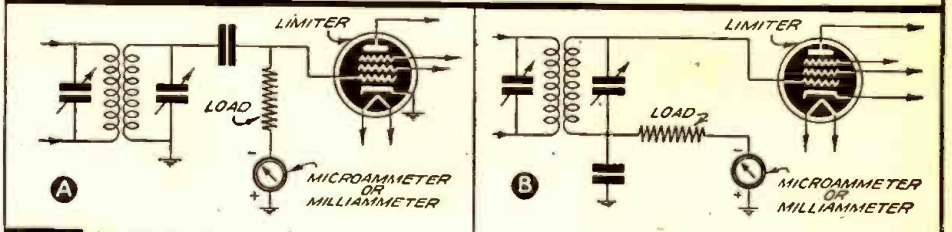

FIG. 18 ~CONNECTING A MICROAMMETER OR MILLIAMMETER TO LIMITER CIRCUIT TO ALIGN I.F. STAGES~

signal generator and a sensitive D.C. indicating instrument are essential. The indicating instrument may be a D.C. vacuum-tube voltmeter or a 10,000 or 20,000 ohms/volt volt-ohmmeter combination with several low-current ranges. Stage-by-stage alignment is employed, starting with the limiter stage input transformer.

The signal generator is adjusted to provide an unmodulated output at the correct intermediate frequency for the receiver under alignment, and is coupled to the control-grid of the I.F. amplifier tube preceding the limiter input transformer. A dummy antenna consisting of a 0.1-mf. condenser, connected in series with the high side of the generator to the tube grid, is important. The ground lead or shield of the generator output cable must be properly grounded to the receiver.

Since the current flowing in the grid circuit of the limiter is proportional to the signal, connection of the output indicator is made to the limiter stage. The mode of connection depends upon the type of indicator and limiter. When an electronic or D.C. vacuum-tube voltmeter is employed, it is only necessary to connect it from the control-grid of the limiter tube and ground, or across the load resistor as shown in Fig. 17. Otherwise, a milliammeter is connected in series with the load resistor, shown in Fig. 18.

In some receivers, a low-value resistor of about 1,000 ohms, part of the limiter load, is provided so that the milliammeter may be shunted across the resistor. Inasmuch as the meter resistance is much less than that of the 1,000-ohm resistor, the greater portion of the grid current will flow through the meter. This circuit is shown at Fig. 19. It is advisable to use twisted-pair leads to connect the meter to the circuit.

Each I.F. stage is adjusted to provide maximum deflection or reading on the D.C. electronic voltmeter or milliammeter, coupling the signal generator successively to the control-grid of each I.F. amplifier to the mixer grid. The adjustment will be found to be broad due to the wide-band characteristics of the I.F. transformers. When this procedure is completed, and with the signal generator coupled to the mixer grid, the frequency setting of the generator should be changed 75 kc. or 100 kc. above and below the correct intermediate frequency, noting the reading on the indicating instrument in each case. When the I.F. amplifier is correctly and accurately aligned, the reading on the meter should decrease an equal amount above and below the intermediate frequency. The alignment should be repeated until this condition results. Keep the signal generator output low when adjusting I.F. stages, just below the point where further increase in signal

output produces no change in the meter reading.

To align the discriminator, the signal generator is coupled to the limiter control-grid or the mixer grid in accordance with individual manufacturers' instructions. In this instance, a strong input signal is required. The output indicator is connected to the discriminator load resistors as shown at Fig. 20A. When a V.-T.V.m. is used, the probe or high side is connected to point A or B, and the ground terminal to the chassis of the receiver. The primary trimmer C_p is adjusted for maximum reading on the meter with the probe at B. The secondary trimmer C_s is aligned for zero reading with the probe at A. When a D.C. milliammeter is employed as the output indicator (a zero-center type is advantageous but not entirely essential), it is

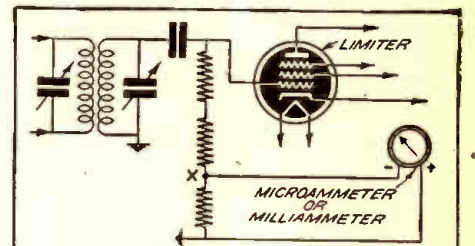

FIG. 19 ~METHOD OF CONNECTING METER TO RECEIVERS EMPLOYING LIMITER CIRCUIT SHOWN~

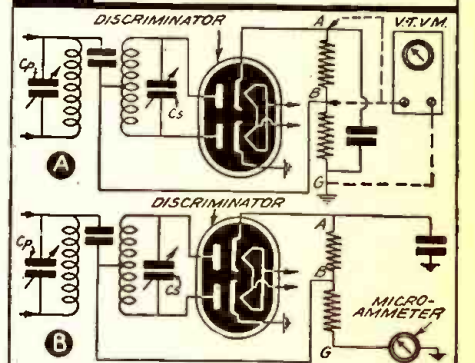

FIG. 20 ~METHOD OF CONNECTING INDICATOR FOR DISCRIMINATOR ALIGNMENT~

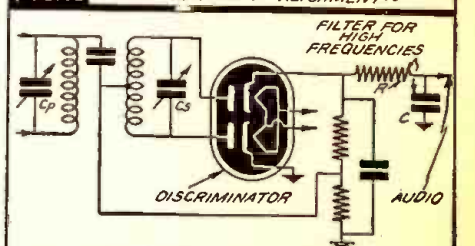

FIG. 21 ~POSITION OF HIGH-FREQUENCY ATTENUATING FILTER IN DISCRIMINATOR AUDIO CIRCUIT. REDUCTION IN R OR C VALUES WILL INCREASE HIGH-FREQUENCY RESPONSE~

connected in series with the lower diode load resistor and ground as shown in Fig. 20B. Trimmer Cp is adjusted for maximum reading and trimmer Cs aligned for zero reading. Care should be exercised when using a microammeter without zero center since the meter will read below scale when the secondary trimmer is adjusted in the other direction.

A high-resistance D.C. voltmeter of 20,000 or 10,000 ohms/volt sensitivity may be used as the indicating instrument and is connected from point A to ground, but the precaution mentioned in connection with meters without zero center must be observed. It is possible to change the zero adjustment of the meter to read up-scale to avoid slamming of the needle off-scale when the secondary trimmer is adjusted.

The following procedure is suggested only as a means of accomplishing I.F. and discriminator alignment when other essential equipment is not available.

Since an audio signal is developed across the limiter load resistor in the circuit shown at Fig. 5, a modulated signal and conventional copper-oxide rectifier type of output meter may be employed to align the I.F. stages in an F.M. receiver. The meter is connected in the usual manner to the output tube plate circuit, and the input of the audio amplifier is connected to the limiter load resistor. The I.F. transformers are then peaked for maximum reading on the meter. The discriminator is aligned by connecting the audio-amplifier input to point B, the junction of the diode load resistors, shown at Fig. 8, and the discriminator transformer trimmers adjusted for maximum indication on the output meter.

R.F. AND OSCILLATOR ALIGNMENT

The alignment of the radio frequency and oscillator stages in an F.M. receiver presents no problem and is carried out in conventional manner, similar in all respects to A.M. receiver alignment. Calibration of the high-frequency end of the F.M. band is possible with the oscillator shunt trimmer, but because of the narrow spread or limits of the band, no oscillator padding condenser is provided. When padding of the oscillator circuit to calibrate the low-frequency end of the band is required, an end turn of the oscillator coil may be shifted slightly to effect the alignment.

In connection with oscillator alignment, it must be remembered that the oscillator in an F.M. receiver of conventional design is operated below the signal frequency, not above, as in A.M. receivers. This is done to avoid possible image frequency interference from the television channels that lie above the F.M. band, and to secure greater oscillator stability. The dummy antenna for R.F. and oscillator alignment consists of a resistor of 100 ohms value connected across the antenna input to the receiver.

RECEIVER TROUBLES

One of the most common complaints reported with F.M. receivers is that of noisy reception. In many instances, this trouble may be traced to insufficient signal input to the receiver. However, we are concerned with those cases where the antenna system is entirely adequate. Lack of balanced receiver input, which renders a good antenna less effective, has been found often. The receiver may have one side of the input transformer primary at ground potential, or capacity coupling between primary and secondary may be present. This condition is made apparent, when connecting only one side of the transmission line to the receiver or connecting one side of the line to one certain input terminal, will provide a stronger signal. The need for a matching transformer is obvious in

this case, so that the effects of unbalance are overcome.

Faulty operation of the limiter will prevent correct clipping action and elimination of amplitude changes in the modulation. This has been found due to changes in resistor values which upset operating potentials. The use of low-tolerance resistors in F.M. receivers indicates the importance of correct values. Since the plate and screen-grid voltages of limiter tubes are low, discrepancies of 10% to 20% are sufficiently great to alter the tube characteristic. The time constant of the resistor and condenser in the limiter circuit has been carefully computed. Substantial changes in these values may produce improper operation.

Another common trouble with F.M. receivers is distortion. This condition is caused by any one or more of a number of failures, but principally, incorrect I.F. discriminator alignment. When the discriminator characteristic is not linear, frequency changes in the signal will not be converted into a sine audio voltage. Misalignment of the I.F. amplifier may result in unequal amplification of the wide frequency band essential for correct operation, and consequently a non-linear discriminator response. Both the I.F. amplifier and discriminator must be aligned to the same frequency and the response of the I.F. amplifier must be equal over the required spread on both sides of the intermediate frequency.

Oscillator stability is an important consideration in F.M. receiver design and most receivers incorporate means to overcome oscillator drift. The use of temperature-compensated condensers is common. In some

PLEASE let the editors know if you like these F.M. articles such as the one presented by Mr. Freed. Also, the editors would be grateful if you would tell them just what points you would like covered in such future F.M. articles.

cases, these components are mounted close to some resistor which carries current and produces heat. An alteration in the relative position of these components may defeat the purpose of the condenser. When parts are replaced, leads and components must be replaced and redressed exactly to their original positions, which must be carefully observed. Should the temperature-compensated condenser require replacement, it is important that a unit not only of the exact capacity be used, but with the same temperature coefficient and in the right direction. Oscillator drift may be due to leakage paths resulting from excessive use of soldering flux and faulty insulation, whose constants change with temperature and humidity. Oscillator drift causes considerable detuning and prevents linear operation of the discriminator, thereby introducing distortion.

Another cause for distortion and noisy reception is oscillation or regeneration, occasioned by faulty bypass condensers, imperfect shielding or bonding, and improper lead dressing. This regeneration is not always apparent in the form of a "whistle", but makes its presence known by the symptoms of distorted reproduction. Tuning condenser chassis bonds, coil and tube shield grounds, and grounding lugs for bypass condensers, may become imperfect. Reliance upon rivets is misplaced and these points are often the reason for regeneration. The open-circuiting or increase in value of the resistors shunted across primary or secondary of I.F. transformers

has been found to produce a similar condition, whereby the resistive loading effect is removed, thus introducing regeneration and distortion. Leakage between grid and cathode of type 1852 and 1853 amplifier tubes is a too-frequent occurrence. It is suggested that these tubes be carefully tested in any convenient manner for leakage, before deciding that misalignment is producing the distortion or weak noisy reception.

One of the advantages claimed for F.M. receivers is the extended high-frequency range. In some cases, brilliance in reproduction of the high frequencies may be lacking or inadequate, despite correct alignment and operation. It is only necessary to change the constants of the filter circuit, shown in Fig. 21, connected between the discriminator and audio amplifier. This filter, consisting of resistance and capacity, is used to attenuate the high-frequency boost introduced in transmission, thereby tending to flatten out the overall audio frequency response. Removal of the filter entirely is not recommended, but a change in the time constant, usually 100 microseconds, may be warranted. By reducing the value of the resistance or capacity, an increase in high-frequency reproduction is secured.

On the whole, the radio technician who recognizes and understands the major differences between F.M. and A.M. receivers should have little difficulty in the installation and service of F.M. receivers.

List of F.M. Articles in RADIO-CRAFT

- An Engineer Analyzes the How and Why of Frequency Modulation, Part I, July '41; Part II, August '41.
- How to Build and Use a Practical Frequency Modulator, Sept. '41.
- New!—F.M. Phono Pickups, August '41.
- Theory and Design Considerations of R.F. and I.F. Coils in F.M. Receivers, June '41.
- Distinctive Calls for F.M. Stations.
- New Circuits in Modern Radio Receivers (Dept.): "New Circuit Using 'Electric Eye' as F.M. Tuning Indicator" (Pilot); "Direct-Coupled Limiter Tubes Used in F.M. Receiver" (Zenith), April '41.
- "Frequency Modulation Receiver Uses 2 Limiters in Cascade" (Scott), Dec. '40.
- "Supplementary Shadows Indicate F.M. Resonance" (Meissner), Nov. '40.
- "Push-button Amplitude—Frequency Modulation Changeover" (Stromberg-Carlson), Aug. '40.
- "Same Tuning Indicator Used Both for Amplitude and Frequency Modulation Receiver" (Stromberg-Carlson); "Tuning Indicator for Frequency-Modulation Receiver" (Stromberg-Carlson), March '40.
- Recent Improvements in F.M.—Receiver Design, March '41.
- A New A.F.—Drift Correcting, Signal-Balancing, Direct-Coupled F.M. 24-Watt Audio Amplifier, Part I, Dec. '40; Part II, Jan. '41; Part III, Feb. '41.
- Circuit Features of the Latest Ultra-H.F. "DX" F.M.—A.M. Receiver, Feb. '41.
- F.M. Servicing Pointers, Jan. '41.
- The ABC of Frequency Modulation, Dec. '40.
- Station WOR Gets F.M. Voice, Dec. '40.
- Present Status of F.M. Broadcasting, Dec. '40.
- F.M. Servicing Procedure, Nov. '40.
- Servicing F.M. Receivers, Oct. '40.
- Servicing F.M. Receivers, Sept. '40.
- Latest 28-Tube DeLuxe High-Fidelity F.M. and A.M. Broadcast Receiver, Sept. '40.
- Build This Practical F.M. Adapter, Aug. '40.
- Choosing an F.M. Antenna, July '40.
- Data Sheets (Dept.): "Stromberg-Carlson, No. 425 Frequency Modulation Receiver and 'Converter'," Feb. '40.
- Frequency-Modulated Programs on Your Present Receiver!—with This Easily-Built F.M.—A.M. Ultra-Shortwave Adapter, Part I, Dec. '39; Part II, Jan. '40.

NEW RADIO OPPORTUNITIES IN THE U. S. NAVAL RESERVE

"Class V-3," the new streamlined classification in the Naval Reserve for radio signalmen and telegraphers, gives RADIO-CRAFT readers an exceptional incentive to "Join the Navy and See the World." The qualifications necessary for membership in this new group, and the prospects for advancement, make the patriotic gesture of thus cooperating in National Defense especially inviting as the following article discloses.

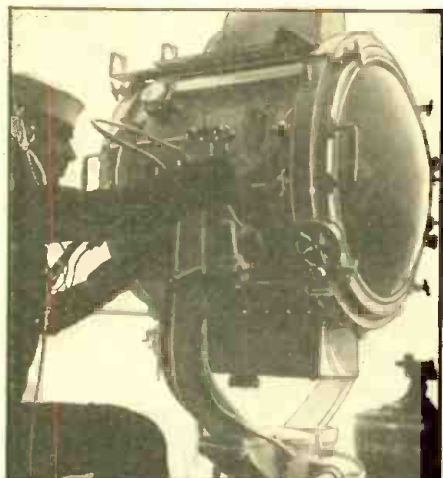

Photo—U. S. Navy Recruiting Bureau
The Navy signalman, here shown sending a message by long and short flashes of light from the searchlight as controlled by a telegraph key under his right-hand, counts a knowledge of radio as only part of his stock in trade. However the urgent need for qualified radiomen is reflected in the new Class V-3 of the United States Naval Reserve, which offers exceptional opportunities not only to Servicemen but to all classes of technicians in the radio field. Not shown in this photograph is the Navy's receiving signalman who ordinarily views the searchlight, up to the limit of visibility, through a powerful telescope. This view illustrates only one of the many activities being taught at Naval Reserve Radio Schools.

WITH the several parts of the world at loggerheads, and the Navy of this country patrolling an ever-increasing area of the Atlantic and Pacific Oceans, opportunities in the *United States Naval Reserve* are numerous and attractive for qualified radio communications men.

CLASS V-3

The aim of the Navy Department in designing the new streamlined *Class V-3* in the Naval Reserve for Radiomen, Signalmen, and Telegraphers, is to permit a man with valuable civilian experience in one of these 3 fields to be enlisted in the Naval Reserve as a Petty Officer, with the corresponding pay and privileges.

The Navy needs men who are specialists in *Radiotelegraphy*. The following paragraphs explain what *Class V-3* of the United States Naval Reserve offers these men both in Petty Officer ratings, and in chances for rapid advancement.

RADIOTELEGRAPHERS — LICENSED.—Men already licensed as radiotelegraphers will be enlisted in *Class V-3* in accordance with Table I. The last 2 columns of this table may be explained in this way.

A man with a license as a radiotelegrapher is given an Advanced Seaman rating upon enlistment. (The untrained applicant is enlisted as Apprentice Seaman.) Shortly after enlistment the licensed man will be examined, and on the basis of this examination he will be given a rating as a Petty Officer (in this case Radioman), 2nd Class,

or 3rd Class, or as a Seaman, 1st Class. The purpose of enlisting trained men at this higher rating is to give them the advantage of the higher pay grades, and to enable them to advance to Chief Radioman (Chief Petty Officer) more rapidly. *The United States Naval Reserve will always take advantage of any specialized training an applicant has received in civilian life.*

RADIOTELEGRAPHERS — NOT LICENSED.—A radiotelegrapher, not yet proficient enough to be licensed by the Federal Communications Commission, who desires to enlist in the U. S. Naval Reserve as radioman, will be enrolled in *Class V-3* as Apprentice Seaman.

He will be sent upon enlistment to a Naval Reserve Radio School, where he will not only receive training as a radio operator, but will also be indoctrinated with Navy procedure and custom.

Upon conclusion of his period of training he will be examined and rated as Seaman, 2nd Class, or 1st Class, or as Petty Officer, depending upon the degree of proficiency which he has attained.

SIGNALMEN.—Qualifications for signalmen in the United States Navy include not only such general technical knowledge as the use of a *stadimeter*, *pelorus*, and *navigator's range finder*, but also a particular and complete familiarity with the signal bridge aboard ship, and with the details of navy practice.

Men with or without previous training (unless this training has been in the United States Navy) who desire to enlist in *Class V-3* of the United States Naval Reserve as signalmen will be enrolled with a rating of Seaman, 2nd Class. When these men have qualified in accordance with an examination, they will be advanced to the rating of Signalman, 3rd Class (Petty Officer, 3rd Class).

TELEGRAPHERS.—Men with civilian training in Morse telegraphy are urged to enlist as *telegraphers* in *Class V-3* of the U. S. Naval Reserve. These men will be given Petty Officer ratings upon enlistment.

Depending upon the amount of training they have received, these men will be enlisted as Chief Telegraphers, or as Telegraphers, 1st, 2nd, or 3rd Class (that is, Chief Petty Officer, or Petty Officer 1st, 2nd, or 3rd Class). Such men will receive

the pay grade corresponding to the rating they receive at the time of enlistment. (See below.)

MEN WITH PREVIOUS NAVY RATINGS.—If a man has been honorably discharged from the Navy or Coast Guard within 3 years with a rating as radioman, signalman, or telegrapher, or seaman striker for these ratings, he is eligible for enlistment in *Class V-3* in the same or corresponding rating to that in which he was discharged.

If such a man, however, has since his discharge received a license as a civilian radiotelegrapher which would, in accordance with the above table, enable him to enlist in *Class V-3* in a higher rating than the one in which he was discharged from the Navy, he will not be held to his former rating with the Navy, but may take advantage of the higher rating.

Men who have been discharged from the Navy or Coast Guard for a period longer than 3 years must secure the approval of the Bureau of Navigation before they can enlist in *Class V-3* at their former rating.

PAY GRADES

Men without specialized training as radiomen, signalmen, or telegraphers will be enlisted as Apprentice Seamen, and will be paid \$21 per month.* Men with specialized training who are enlisted with a rating will be paid according to the following scale:

RATING	*PAY PER MONTH
Seaman, 2nd Class	\$36
Seaman, 1st Class	\$54
Petty Officer, 3rd Class	\$60
**Petty Officer, 2nd Class	\$72
**Petty Officer, 1st Class	\$84
**Chief Petty Officer (Acting Appointment)	\$99
**Chief Petty Officer (Permanent Appointment)	\$126

GENERAL QUALIFICATIONS

All applicants for *Class V-3* of the United States Naval Reserve must be between the ages of 17 and 36. They must be intelligent
(Continued on page 241)

*In addition to the pay listed here, all men are provided with food and quarters, and are given an initial clothing allowance equivalent to \$118.
**These men will be given an additional allowance if they have dependents.

LICENSE HELD	*RATING IN WHICH ENLISTED	*AUTHORIZED RATING WHEN QUALIFIED
RADIOTELEGRAPH — COMMERCIAL:		
1st Class	Seaman, 1st Class	Radioman, 2nd Class
2nd Class	Seaman, 1st Class	Radioman, 2nd Class
Operator's permit	Seaman, 1st Class	Radioman, 3rd Class
RADIOTELEGRAPH — AMATEUR:		
Class A or B	Seaman, 1st Class	Radioman, 3rd Class
Class C	Seaman, 2nd Class	Seaman, 1st Class

*Cf. corresponding pay grades above under "PAY GRADES."

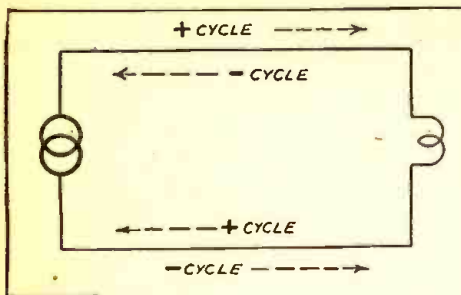

FIG. 1A

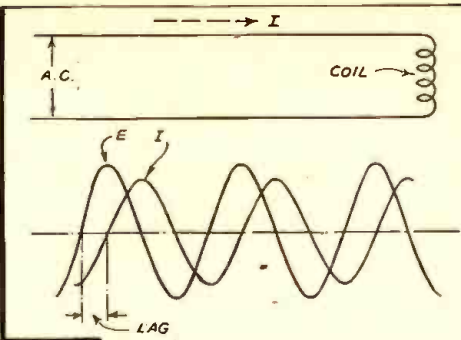

FIG. 2A

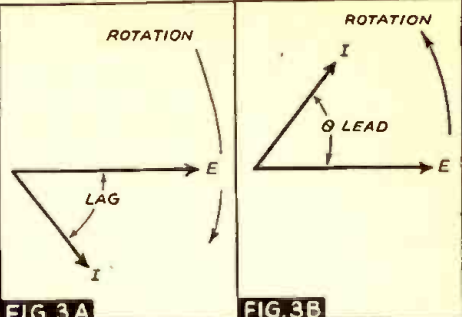

FIG. 3A

FIG. 3B

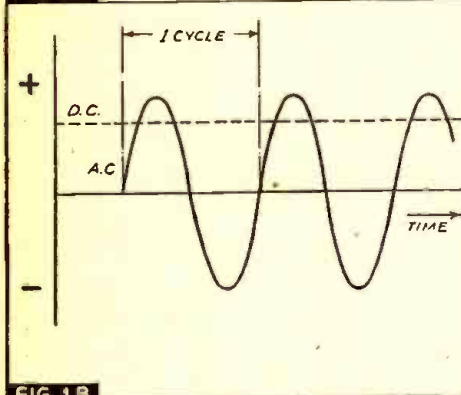

FIG. 1B

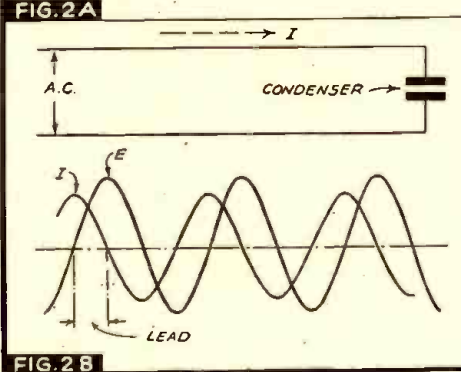

FIG. 2B

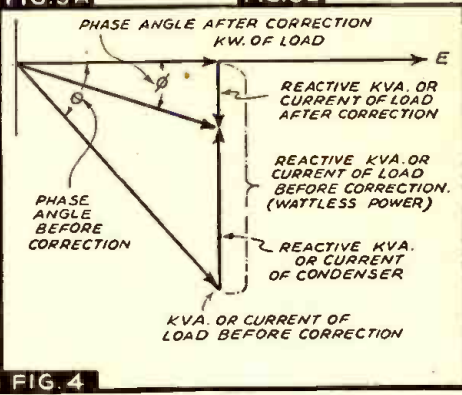

FIG. 4

POWER FACTOR CORRECTION

The widespread use of fluorescent lights which are low power factor devices has brought to the fore the disadvantage of low power factor operation on A.C. power lines. Just how power factor affects the power requirements and the cost of operation of not only fluorescent lighting equipment but other pieces of electric apparatus operated on A.C. is here described in an accurate, graphic and unusually understandable manner. This includes an elementary analysis of A.C. versus D.C. theory. The article is a reprint from The Aerovox Research Worker, house organ of Aerovox Corporation.

RECENT developments in the use of fluorescent lamps have brought to the fore the disadvantages of low power factor operation on A.C. power lines. The disadvantages are not only of importance to the power companies, which long have known and tried to correct them, but to the users of power as well, who up to now have done very little about low power factor operation.

The widespread use of fluorescent lights, which are low power factor devices, has made the use of power factor correction equipment of importance to both power company and power user.

The power companies are concerned because these lamps require about twice as much current as an incandescent lamp of the same power rating. The electric bills, however, are determined not by the current but by the power in watts used.

The user of these lamps is concerned because the number of lamps that can be connected to a branch circuit is only one-half the number of Mazda lamps of the same power rating. Moreover, the power lost in the line is 4 times greater than with an equivalent light load of Mazdas. The actual cost of this power may not be very great, but it does show up in a larger line voltage drop and increased flickering of the lights as lights or other loads are turned off and on.

To explain this, a brief review of the fundamentals of alternating current theory is desirable.

FUNDAMENTAL A.C. AND D.C. THEORY

An alternating current or voltage differs from a direct current or voltage insofar as

the flow of current, or the force of the voltage, is not always in one direction, but actually reverses itself twice a cycle. This can be observed by the shock received when an alternating voltage is applied to the body. When such a voltage, of sufficiently low value so that it can be endured for some time, is applied to the body, a vibrating or tickling sensation is observed. When a direct voltage is applied to the body, the sensation is not vibratory, but constant.

Graphically this is shown in Fig. 1, which depicts the variation of the magnitude of the voltage with time. If the values above the zero line are considered positive, the current can be considered flowing from the generator to the lamp for one-half of the cycle, and from the lamp back to the generator during the second half of the cycle, as shown by the current lying below the zero line. A direct current is represented by the dotted line, which shows a constant current flowing in one direction at all times.

Since the voltage of the generator changes direction twice a cycle, the current will change its direction of flow in step with the voltage. The current, however, may lag behind the voltage, or even lead it depending on the type of circuit connected to the generator or the line. If the load is a coil, the current will lag the voltage, although maintaining the same rate of alternation. When a condenser is connected to the line, the current through the condenser will lead the voltage. This is illustrated in Fig. 2. It will be noted that the effect of the condenser is opposite to the effect of the coil, as far as the relative timing of the currents is concerned.

The use of the curves to illustrate the relative timing of the current and voltage

is rather awkward, and to simplify this, the vector form is used. By definition, a vector is a quantity having magnitude and direction. Thus a wind blowing toward the northeast with a velocity of 10 miles per hour could be represented by an arrow 10 units long pointing northeast. A wind can be considered more or less constant in magnitude and direction for fairly long periods of time, but alternating currents or voltages change direction rapidly, reversing 120 times per second for a 60-cycle system.

For this reason, vectors used to represent or illustrate alternating currents or voltages are considered as rotating, although they are always drawn in a fixed position. The direction of rotation is normally counter-clockwise so that the relative timing of 2 or more alternating currents or voltages can be represented by the position of their vectors. Figure 3 shows how the currents and voltages of Fig. 2 would be depicted.

From a power point of view, the Alternating Current System differs from the Direct Current System in that the product of current and voltage is not power in watts.

To obtain the power in watts for an alternating current system, it is necessary to multiply the product of current and voltage by a factor called power factor. The value of the power factor can never be greater than "1" and is usually less than "1." In fact, the power factor may be "zero" so that it is theoretically possible to have a circuit in which current is flowing, yet no power (such as would be recorded on a watt-hour meter) would be taken from the line. Or, from the other point of view, a given power load, such as an induction motor operating at 50% power factor, would

TABLE I
POWER FACTOR CALCULATION

P.F.	K.	P.F.	K.	P.F.	K.
20	4.890	47	1.877	74	.909
21	4.656	48	1.828	75	.882
22	4.433	49	1.779	76	.855
23	4.231	50	1.732	77	.829
24	4.045	51	1.687	78	.802
25	3.873	52	1.643	79	.776
26	3.714	53	1.600	80	.750
27	3.566	54	1.559	81	.724
28	3.429	55	1.518	82	.698
29	3.300	56	1.477	83	.672
30	3.180	57	1.442	84	.646
31	3.067	58	1.405	85	.620
32	2.961	59	1.368	86	.593
33	2.861	60	1.333	87	.567
34	2.766	61	1.299	88	.540
35	2.676	62	1.266	89	.512
36	2.592	63	1.233	90	.484
37	2.511	64	1.201	91	.456
38	2.434	65	1.169	92	.426
39	2.361	66	1.138	93	.395
40	2.291	67	1.108	94	.363
41	2.225	68	1.078	95	.329
42	2.161	69	1.049	96	.292
43	2.100	70	1.020	97	.251
44	2.041	71	.992	98	.203
45	1.930	73	.936	100	.142
46	1.930	73	.936	100	.142

The above table gives K values for each Power Factor. In order to obtain the required K.V.A. (kilovoltamperes), it is only necessary to subtract one K from the other and multiply this by the kw. (kilowatt) load. Example: Correct a 10-kw. load 220 V.-60 cycle at 64% power factor to 90% power factor.

K at 64% = 1.201
K at 90% = .484

7.17

7.17 × 10 kw. = 7.17 K.V.A. required

From table below, 220 V. = 55 mf. per K.V.A. The corrective capacity necessary is 55 × 7.17 = 394 mf.

Volt	Mf. per K.V.A.
110 V.	219 mf.
220	55
330	24.3
440	13.8
550	8.76
660	6.09
880	3.42

require twice as much current as a motor driving the same load but operating at 100% power factor. The wire necessary for running the 50% power factor motor would be twice as large in cross-section. The same can be said of any load operating at low power factor. A power factor of 100% is the ideal condition, but power factors of 85 to 95% usually are considered satisfactory.

POWER FACTOR CORRECTION

Normal devices, such as motors and fluorescent lamps, have lagging power factors; while Mazda lamps and heaters have power factors which are nearly 100%. Condensers (including refrigerator "capacitors"), however, have power factors that are nearly zero (about 1% or less), but leading. Since the current taken by a condenser leads the voltage, it is possible to use condensers to cancel-out the lagging currents of devices which operate at lagging power factors. Connecting a condenser of the correct value across the line at the terminals of a motor will cause the line current to decrease.

To determine the current value of condenser for any given load requires the use of trigonometry, or charts that have been made to eliminate the use of trigonometry as such. Table I gives the multiplying factors which are used to compute the volt-ampere capacity of the condenser required for the correction of any load.

The Table is based on the following theory:

Fig. 5. This curve in conjunction with Table I helps quickly solve the problem of condenser rating in K.V.A. when the condenser capacity and voltage values are known.

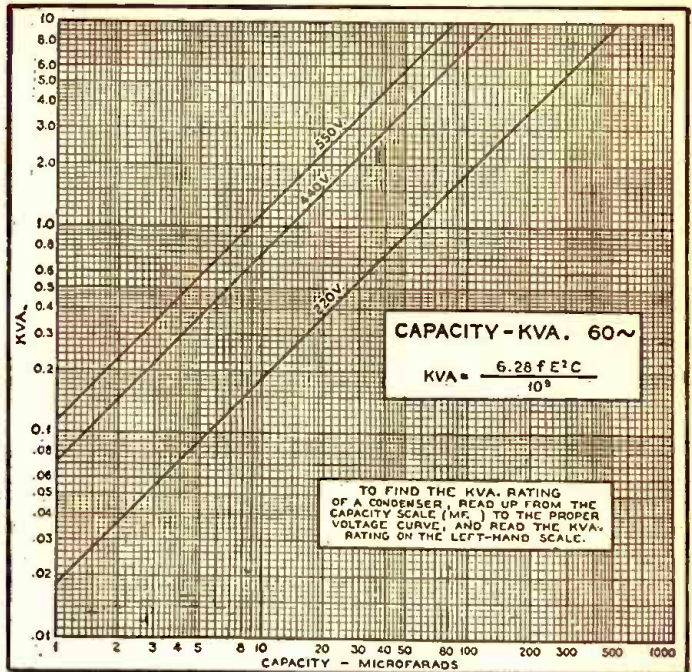

Figure 4 shows the vector diagram for a single-phase load of lagging power factor before and after correction. Note that the actual power is unchanged except for the small amount taken by the condenser.

The total load is considered as consisting of 2 parts, (1) the power components marked "kw." and (2) the wattless component marked "reactive K.V.A." or "current." To improve the power factor, it is necessary to reduce the magnitude of the reactive component. The connection of a condenser across the line at the load terminals will reduce the load reactive component by the value of the condenser K.V.A. component. The equations are given below.

- (1) $P.F. = \cos \phi = \frac{kw.}{K.V.A.}$
- (2) $K.V.A. = \frac{kw.}{P.F.}$
- (3) before correction $R.K.V.A. = K.V.A. \sin \phi = kw. \tan \phi$
- (4) after correction $R.K.V.A. = R.K.V.A. - \text{Cond. K.V.A.}$

New P.F. = $\cos \phi = \cos \tan^{-1} \frac{R.K.V.A.}{kw.}$

(5) $Cap. K.V.A. = \frac{0.377 CE^2}{1,000,000}$

E is line voltage.
C is capacity in microfarads.
 $C = \frac{2,650,000 K.V.A.}{E^2}$

Table I, however, simplifies the computation as shown by the following example:

A 5-horsepower, single-phase motor operates on a 220-volt line, drawing 4.4 kw. and 28 amperes. It is desired to improve the power factor to 95%.

The present power factor:
 $P.F. = \frac{4400}{220 \times 28} = \frac{4400}{6160} = .715$

From the Table, the R.K.V.A. factor for .715 P.F. is .98, and for .95 P.F. the R.K.V.A. factor is .324. The difference between the two R.K.V.A. factors multiplied by the power, which is 4.4 kw., gives the condenser K.V.A. required.

Thus the condenser K.V.A. = 4.4

(.978-.329) = 4.4 × .649 = 2.86 or the required capacity is:

$C = 2,650,000 \left(\frac{2.86}{220^2} \right) = 157 \text{ mfd.}$

For polyphase systems the capacity will be divided into as many groups as there are phases, and one group will be connected across each phase. The computations will be exactly as outlined above if the K.V.A. and kw. values are known. If the current and voltage between lines and the line current are given, the K.V.A. is found by the following equations:

For single-phase (2-wire) $\frac{E_L I_L}{1000}$

For 2-phase (3-wire) $\frac{2E_L I_L}{1000}$

For 3-phase (3- or 4-wire) $\frac{\sqrt{3}E_L I_L}{1000}$

E_L = voltage between phases or lines
 I_L = current in line

THE ECONOMICS OF POWER FACTOR CORRECTION

In addition to the installation of power factor correction equipment, when required by law or power company regulations, it is often economical to install such corrective equipment in existing wiring systems. For example, the wiring capacity of a system can be increased without changing the wire size as was done in the following installation.

A small plant had a connected load of 73, ¼-horsepower motors, and 2, 5-horsepower motors. The line feeding the fractional horsepower motors was a 3/0 rubber-covered cable with a capacity of 175 amperes. Increased business required the installation of 15 additional machines of the same type. This would require running an additional line from the main panel board.

The installation of 0.25-K.V.A. condensers across each motor decreased the full load current of each motor from 3.3 amperes to 2.5 amperes and decreased the maximum line current from 168 amperes to 129 amperes. Thus the capacity of the existing line was increased by 30%, allowing the installation of 22 additional machines with-

(Continued on page 241)

REDUCING PHONO TRACKING ERROR

In the following article the author offers mathematical proof that phono tracking error may exist to a considerable degree, in the reproduction of sound-on-disc, although the error may be evident only to the trained ear. The importance of reducing this error is brought out in a description of the author's personal experiences in record reproduction; a simple method of accomplishing this improvement is suggested.

WILLIAM I. POWELL

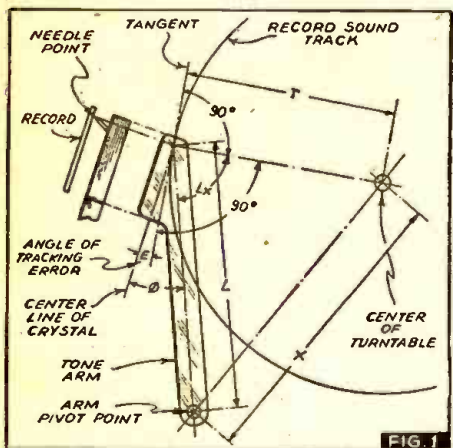

"E" shown in Fig. 1 should be zero for the elimination of this mechanical flaw. It will be found, however, to vary in size from some minimum value with the position of the arm on the record or change in sound-track radius to the particular L, X, and θ chosen.

Some records owned by the writer, who possesses a late-model 1941 radio - phonograph of well known make, were played at a friend's home some months ago with disappointing results to the writer, although they sounded naturally to the host! (Evidence of the fact that the human ear can accustom itself to any constant condition.) It was noted, at the time, that the machine was one of the small, low-priced record players possessing a straight tonearm or one in which the center line of the crystal coincides with that of the tonearm.

Because of the audible difference in the sound reproduction between the two machines, the writer's curiosity was aroused and the thought occurred that possibly a serious tracking error difference existed in the two. So the dimensions L and X (Fig. 1) were taken on the friend's machine and these same with the angle θ on the author's for subsequent investigation.

Not being entirely content with the investigation on two machines only and feeling that a third machine would afford better comparative results, the author visited the home of a second friend with the same records. This home contained another 1941 radio - phonograph of well known make. Here, although the results were not so startling, there was, nevertheless, a difference in the reproduction of the music. The measurements L, X and θ were taken and the writer proceeded at his home to make an analysis of the tracking error conditions of the two machines along with his own.

In the first case, which was that of the straight tonearm on the small player, unusually high error values were found (approx. 16°-30') and no practical means could be evolved for their reduction within reasonable limits. Because of this, attempts at correction were discarded and all further consideration of this type arm was abandoned. Since most superior-quality record players and radio - phonographs possess some form of the tangential principle in the arm construction, there is evidence to indicate that the straight arm is rapidly becoming discarded.

The calculations and subsequent conclusions accompanying this article are therefore based on the two latter cases (the two 1941 radio - phonographs) and purport to show that these possess an unwarranted amount of tracking error.

The method used for correction shown here is one developed by the writer and will be found to be simple in application once it has been reviewed. The results show that the existing condition is due either to ignorance of its existence, insufficient study along the lines of the following analysis, or reluctance and/or inertia on the part of manufacturers to change certain cabinet or motorboard dimensions to accommodate the proper L, X and θ dimensions.

CASE ANALYSES

In Fig. 2, curve A represents the actual variation in tracking error found in one machine while curve a shows the reduction occasioned by small changes in the lengths x and L. Curves B and b show a similar relationship for a second machine. The following analysis for curves A and a is sufficient to illustrate the procedure which can be duplicated for any case:

CURVE A

Referring to Fig. 1
 $L=7"$, $X=6.625"$, $\theta=25^\circ$
 maximum sound track $r=5.75"$
 minimum sound track $r=1.875"$

ERROR E AT $r=1.875"$

From the law of cosines we have,
 $6.625^2 = 7^2 + 1.875^2 - 2 \times 7 \times 1.875 \times \cos Lx$
 $44 = 49 + 3.52 - 26.25 \cos Lx$

from which

$\cos Lx = .324$ and $Lx = 71^\circ - 04'$
 $E = (25^\circ + Lx) - 90^\circ = + (6^\circ - 04')$

THE VALUE OF r WHEN E=0

$44 = 49 + r^2 - 14r \cos 65^\circ$
 $44 = 49 + r^2 - 5.92r$

which by completing the square gives
 $r = 5.035"$

ERROR E AT $r=5.75"$

$44 = 49 + 33 - 80.5 \cos Lx$
 38

$\cos Lx = \frac{38}{80.5} = .472$ $Lx = 61^\circ - 49'$

$E = (61^\circ - 49') - 65^\circ = - (3^\circ - 11')$

The next step is the solution for the magnitude and the location of the maximum error between $r=1.875"$ and $5.035"$. Solving for y, or the distance from the center to the point of maximum error, we have,
 $44 = 49 + y^2 - 14y \cos Lx$

$y^2 + 5$

or $\cos Lx = \frac{14y}{44}$

and taking the first derivative

$d \cos Lx = \frac{y^2 - 5}{14y^2}$

$\frac{dy}{dy} = \frac{14y^2}{14y^2}$

setting this derivative equal to zero to find the maximum value gives $y=0$ or $2.24"$.

WITH the development of the electric pickup for sound reproduction from phonograph records, the popularity of recorded music has been greatly increased. Along with this increase in popularity there has been a more intensive study of some of the factors which are responsible for the tone distortion or lack of fidelity commonly found in electric record players.

Sound distortion can manifest itself in many ways, some of which are fuzziness or blurred tone or an imbalance of high and low tones, all of which were not in the music when played in the recording studio. It is to be noted here that the average human ear is a relatively poor judge of this distortion for it will only be evident to most listeners if the same recording is played on two or more different machines which are adjacent to each other in the same room.

Also since approximately 75% of the records bought and played today are of the popular variety where rhythm and syncopated effects are the chief aim, the record listening public is as yet not overcritical of the reproduction.

However, with the recent slashes in the prices of classical records by the big companies and the popularized special offers of lighter classical records, it is felt that there will be an increasing demand for superior machines which will more nearly approach a lifelike quality in reproduction.

TRACKING ERROR

Among the mechanical contributors to tonal distortion is a flaw called tracking error. This error, although greatly reduced by the development of the tangential tonearm, such as that shown in Fig. 1, can be still further reduced with a consequent gain in fidelity.

Consumer's Research, Inc., in their June 1940 Bulletin state that "a phonograph needle should theoretically stand in the sound track at a slight angle from the vertical and should move across the record in such a way that its plane is at all times normal or perpendicular to the radius of the groove", also—"some form of tracking error correction is desirable if only as a very inexpensive insurance against a potential fault". This means that the angle

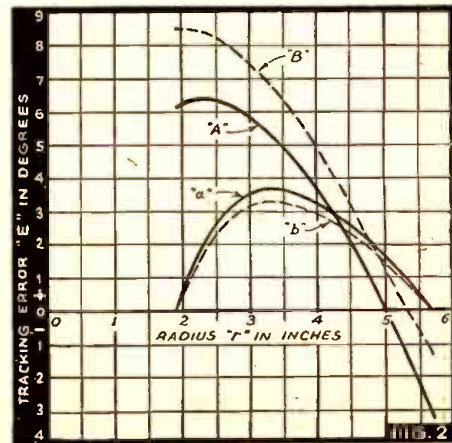

Obviously 2.24" is the rational value.

$$\text{Then } \cos Lx = \frac{5+5}{31.35} = .319 \quad Lx = 71^\circ - 23'$$

E at this point = $(71^\circ - 23') - 65^\circ = + (6^\circ - 23')$
In the foregoing manner other points were computed to complete curve A.

CURVE a

If it is assumed that $E=0$ at $r=1.875''$ and $5.75''$ and lengths L and x can be computed in the following manner, by subtraction—
 $+X^2 = L^2 + 33 - 11.5L \cos 65^\circ$
 $-X^2 = -L^2 - 3.52 + 3.75L \cos 65^\circ$

$$0 = 0 + 29.48 - 4.87L + 1.58L \quad \text{or } L = 8.95''$$

$$X = \sqrt{83.52 - 14.2} = 8.33''$$

MAXIMUM E BETWEEN $r=1.875''$ and $r=5.75''$

$$69.4 = 80 + y^2 - 17.9y \quad \cos Lx$$

$$y^2 + 10.6$$

$$\cos Lx = \frac{17.9y}{y^2 + 10.6}$$

again taking the first derivative and setting to zero

$$d \cos Lx = \frac{y^2 - 10.6}{dy} = \frac{17.9y^2}{10.6 + 10.6}$$

gives $y=0$ or $3.26''$ and using $y=3.26''$

$$\cos Lx = \frac{58.3}{.364} \quad Lx = 68^\circ - 40'$$

Max. $E = (68^\circ - 40') - 65^\circ = + (3^\circ - 40')$

Curves B and b were similarly computed and plotted as shown in Fig. 2 from the following data:

for curve B, $L=7.75''$, $x=7.5''$, $\phi=23^\circ$
for curve b, $L=9.73''$, $x=9.16''$, $\phi=23^\circ$

CONCLUSION

Curves a and b represent only one of many possible variations which may be achieved in each case. Other combinations of L , x , and ϕ will produce differing results.

OPPORTUNITIES IN NAVAL RESERVE

(Continued from page 237)

men of good character and moral reputation; they must have no dependents, or be able to support those which they have. They must be in first-class physical condition.

Applicants for Class V-3 must be native-born or fully-naturalized citizens of the United States, and they will be required to produce birth certificates or other satisfactory evidence of birth.

TERM OF ENLISTMENT

By order of the Secretary of the Navy all enlistments today in the United States Naval Reserve are for the duration of the Emergency. The nominal term of enlistment is for 4 years. But if the National Emergency ends several months after a man enlists in Class V-3, that man will be returned to his civilian job as soon as possible. He will not be required to serve out his term of enlistment in active duty.

Specific information with regard to any part of Class V-3, or with reference to the possibility of a candidate's being enlisted in a rating, will be forwarded upon application to the nearest Navy Recruiting Station.

Many Important New Articles of Interest to all SERVICE MEN are scheduled for the next issue of this magazine—YOU cannot afford to miss these valuable features! Pointers on F-M and general service procedure, which will save you time and money.—The Editors

POWER FACTOR CORRECTION

(Continued from page 239)

out interruption of service, and saving the cost of running 350 feet of new conduit and pulling wire.

In addition to the increased capacity, a saving in power resulted from the decrease in line current. This saving amounted to 123 kw. hours per month based on 23 8-hour working days. The voltage drop was also decreased, resulting in better operation of the machines.

The most economical size of condenser for any installation will depend on the relative saving and the cost of the condenser. Usually it is not economical to correct the power factor to better than 90%, although there may be cases where 100% correction would be desirable. Such may be the case where the increased line capacity warrants the improvement to 100%.

Over-correction of power factor is seldom warranted. As the capacity across any line is increased, the line current will decrease until 100% power factor is reached and then will increase again. The power factor also decreases, but is said to be leading.

New SELF-BALANCING DRIFT-CORRECTING
DIRECT-COUPLED AMPLIFIERS
FOR DISCRIMINATING MUSIC LOVERS
Designed by A. C. Shoney



These new amplifiers bridge the gap between the laboratory and the home, and make available for the first time, extraordinary equipment at less than ordinary prices. Built in a new way, without interstage coupling condensers or transformers. Although specifically designed to meet the strictest requirements of professional sound engineers, these direct-coupled amplifiers embody all desirable features sought by the most discriminating music lovers. Send for literature.

AMPLIFIER CO. of AMERICA
17 W. 20TH STREET, NEW YORK, N. Y.

Simplest WAY TO REPLACE BALLASTS

4 STANDARD TYPES of Amperite Regulators replace over 200 types of AC-DC Ballast Tubes now in use. Has patented automatic starting resistor. List \$1.00

WRITE FOR REPLACEMENT CHART "S"
Amperite Co. 561 Broadway, N. Y. C.

AMPERITE

NEW AUDIOGRAPH Sound Catalog

AUDIOGRAPH Sound Systems represent the latest in Sound Engineering and Design—a complete line plus pre-tested accessories.

NEW LOWER PRICES
Outstanding quality and performance at prices that help you meet any competition.

WRITE FOR FREE COPY
JOHN MECK INDUSTRIES
1313 W. Randolph St., Chicago, Ill.

HIGH EFFICIENCY! University Reflex Speakers will project sound clearly for two miles with less than 25 watts input. Write for catalogue.

UNIVERSITY LABORATORIES
135 Chrystie St. New York City



University

MILITARY TYPE Handi-Mike

Unexcelled for use with mobile trans., sound trucks, call systems, sports arenas, carnivals, etc. Clear, crisp voice repro. Bal. grip, pol. chrome plate, snap switch, 6 ft. flex cord. Choice of circuits and switches, zinc or double button carbon, crystal or dynamic. All impedances. At your dealer or jobber.

UNIVERSAL MICROPHONE CO., Ltd.
Inglewood, Calif., U. S. A.



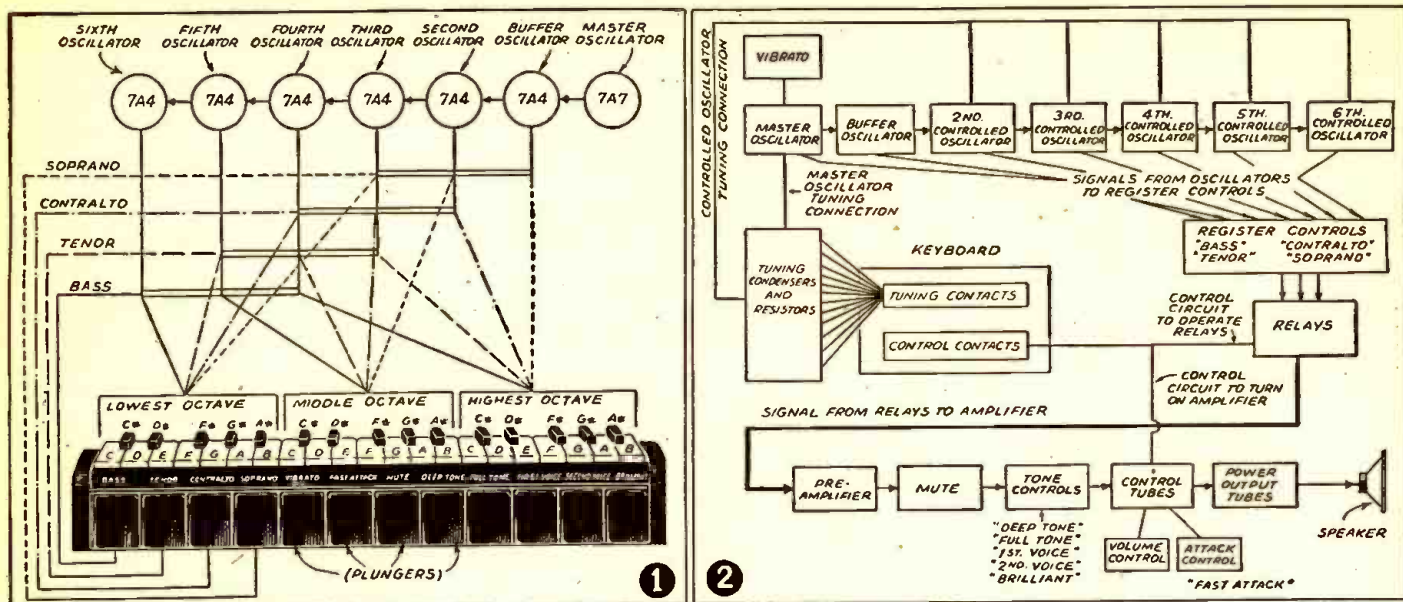

SERVICING MUSIC INSTRUMENTS

Why This Article?

Dear Editor:

I enclose an article on the subject of electronic musical instrument servicing which we would like to see published in Radio-Craft. An increasing number of radio Servicemen are being called upon to service our instruments and we feel that publication of this material in your magazine is one effective way of introducing our products to radio technicians everywhere.

In preparing this material I have emphasized the "how it works" idea because obviously the first step in servicing any such special equipment is to understand the basic operating principle. Further, the numerous inquiries we have received from radio Servicemen asking help in repairing our instrument shows a very definite need for knowledge about how to distinguish one note from another and the relationship of octaves on a keyboard. As you will note, the illustrations prepared for this article cover these points in detail.

G. A. HODSON,

Organ Service Manager

HAMMOND INSTRUMENT COMPANY

A NEW customer has joined the "public" served by radio Servicemen. He is the musician who calls to report that middle "C" is sounding an octave high; or, that his instrument (which is complete with amplifier and loudspeakers) has developed hum. And his orchestra goes on the air at 8 o'clock; or, the family is entertaining and must have music! Here, indeed, is a new field for the radio man—a field which asks little specialized preparation and should pay well,

TYPES OF INSTRUMENTS

Electronic musical instruments fall into 2 general classifications. (1) True electronic instruments generating electric current of different frequencies by means of vacuum-tube oscillators or electromagnetic or photoelectric devices comprise one group. Both tone-generating and amplifying units of these instruments call for a knowledge of circuits and thus invite the technician with radio experience. Examples are Hammond organ, Novachord and Solovox, and RCA's Therman.

(2) Semi-electronic and electrically-amplified musical instruments make up another group. These are conventional instruments with tuned strings or reeds with vibrations picked up by some such means as electrostatic or piezoelectric systems. Servicing the amplification and pick-up units in these instruments present another opportunity to radio technicians. Typical of this group are the Orgatron, Reed Organ, Meissner Electric Piano, and numerous Electric Guitars.

We shall limit ourselves here to a few of the true electronic instruments which are en-

joying wide distribution. These are some of the most successful commercial instruments marketed since music making began to interest electronic engineers. Our treatment here will be limited to a description of what happens when a key is depressed. Average radio Servicemen can follow the circuit diagrams but frequently have trouble servicing these instruments because they lack a clear understanding of "how it works."

You don't have to know how to play "My Old Kentucky Home" to get your share of this work, but you should learn to distinguish one note from another and you ought to know about "octave intervals." So look at Fig. 1 which is the 3-octave keyboard of the Solovox (a melody instrument made as a piano attachment).

Keyboard instruments are divided into octaves of 12 notes each with 7 naturals (white keys) and 5 sharps or flats (black keys) in a definite sequence. Highest note of the Solovox is "B" at extreme-right with a fundamental frequency of 3,951 cycles-per-second (or c./s.). The 2nd "B" (highest note in the middle octave and in identical position with reference to other notes) is the octave interval with a frequency of 1,975.5 c./s. or exactly one-half of high "B." Similarly "B" note in the lowest octave is another octave interval with a frequency of 987.7 c./s. The same applies to all other notes of the scale from octave to octave.

THE SOLOVOX

All notes of the Solovox are controlled by a single radio-type vacuum-tube oscillator operating at the audio frequencies of the

highest octave of the instrument. (2,093-3,951 c./s.) Each time a key is depressed, a switch under it tunes this "master" oscillator to the pitch associated with the key in this highest octave range. Thus, whenever a "C" key is depressed (the tuning contacts for all the "Cs" are in parallel) this oscillator is tuned to 2,093 c./s., which is its lowest frequency. If a "B" note is depressed the frequency will be 3,951 c./s., which is its highest frequency.

The output of this master oscillator controls the frequency of a 1st controlled oscillator (called the "buffer" oscillator) which is adjusted to operate at the same frequency as the master oscillator. The output of this buffer oscillator, in turn, controls the frequency of the 2nd controlled oscillator so adjusted to oscillate at one-half the frequency of the first oscillator. This new frequency corresponds to a note of pitch 1 octave lower than the buffer oscillator.

Similar cascaded oscillators provide pitches of 2, 3, 4, and 5 octaves below that of the 1st controlled or buffer oscillator. In this way, each time the master oscillator is tuned to some given note, each of these 6 controlled oscillators produces a note which is in exact octave relation to the master, thus forming a series of 6 notes in exact octave relationship. The particular oscillator selected for sounding through the amplifier and speaker depends upon the particular playing key depressed, and also upon which of the register controls (Bass, Tenor, Contralto, Soprano) are used, as shown in Fig. 1.

For example, using the "Soprano" tablet,

**New Direct-Coupled FM - AM
AMPLIFIER MANUAL**

By **A. C. SHANEY**
Chief Engineer, Amplifier Co. of America



**For the Layman, Serviceman
Recordist and Engineer**

Regardless of whether you are interested in the finest type of phonograph reproduction, high fidelity recording, sound-on-film applications, FM or AM programs, you will find invaluable information in this practical handbook. Written by the leading exponent of direct-coupled amplifiers who has spent more than 10 years improving and perfecting the famous Loftin-White circuit.

Explains the theory and practical application of:

- Variable Speed Non-Overloading Push-Pull Expansion
- Non-Frequency Discriminating Scratch Suppression
- Push-Pull Balanced Direct-Coupled Amplification
- Push-Pull High-Frequency Equalization
- Push-Pull Low-Frequency Equalization
- Push-Pull Volume Compression
- Automatic Volume Limitation
- Automatic Volume Control
- Calibrated V. U. Indicator
- Audio Spectrum Control
- Remote Control

If you are interested in the latest audio developments, you can't afford to be without this complete compilation of authentic articles on Direct-Coupled Amplifiers. 82 pages 8 1/2" x 11". Over 100 diagrams and illustrations.

Priced to Cover Cost of **20c**
Printing and Mailing

Send Stamps or Coins

AMPLIFIER CO. of AMERICA
17 WEST 20TH STREET, NEW YORK, N. Y.

**MYSTERIOUS
LODESTONE**



We present our genuine **DYNAMIC LODESTONE**, the most remarkable natural live magnet known. Not man-made, but found in nature. Known as Magnetite. History abounds with legends about the mysterious power of Lodestone. Mohammed's coffin in the Great Mosque at Medina was supposed to have been suspended for centuries held in space only by powerful Lodestones.

Many regard Lodestone as being endowed with miraculous powers. It has been used for centuries as a charm and talisman. The ancients, from Phoenicians to the Romans, believed that it had the power to attract love and keep it secure. The high castes in India thought that it created and preserved manly vigor.

All our specimens are specially selected for high power.

50 Fascinating Experiments

can be performed with our **DYNAMIC LODESTONE**. We give full directions showing how these instructive and mysterious experiments can be performed even by a child. In addition to the Lodestone, we supply a genuine magnetic compass to show the power of Lodestone and a supply of iron filings to "bewhisker" the Lodestone. Entire outfit including Lodestone, compass, filings, directions, etc., only 50c. Postpaid.

Order today. Send money-order, cash or new U.S. stamps.

NATIONAL PLANS INSTITUTE

246-R 5TH AVE. NEW YORK CITY

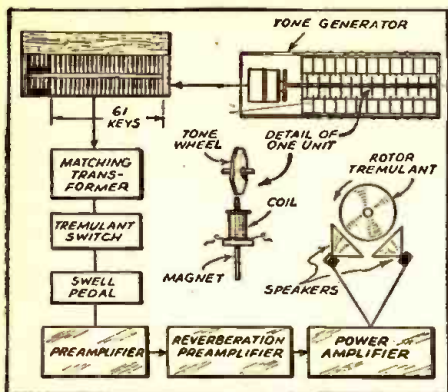

Fig. 3. Schematic of Solovox

the tone of the highest octave is supplied by the master oscillator through the buffer oscillator, middle octave is supplied by the 2nd controlled oscillator, and lowest octave by the 3rd controlled oscillator. Then by changing to "Contralto," the tone of the entire keyboard drops an octave so that the highest octave is supplied by the 2nd controlled oscillator, etc. When the notes of the lowest octave are depressed with the "Bass" tablet in, the lowest tones of the Solovox, produced by the 6th controlled oscillator, sound.

A 2nd contact under each key operates an electrical relay, having contacts to select the desired oscillator. There are 3 relays—one for each of the 3 octaves of keys. A further function of the 2nd key contact is to transmit the signal to the speaker with a controlled rate of attack so as not to be musically abrupt. Tuned electrical circuits and tone controls similar to radio tone controls alter the quality of tone over a wide range.

The block diagram, Fig. 2, shows all the parts of the Solovox and how they are interconnected. In the completed instrument key contacts, tuning condensers and resistors, vibrato reed, and all controls are a part of the keyboard. The tone cabinet contains oscillator, relay and amplifier channels including loudspeaker.

THE HAMMOND ORGAN

Tone generators produce the frequencies of the Hammond Organ by means of electromagnetic alternators driven by a synchronous motor. Each alternator consists of a small bar magnet with a pick-up coil

wound around one end, and a steel tone wheel with a number of high spots or teeth. As the tone wheel revolves these high spots vary the field of the magnet and induce a tiny current in the coil. One of these tone wheels, for example, rotates at such speed that 440 high spots pass the magnet each second generating the fundamental of note "A" above middle "C."

Figure 3 shows in block diagram what happens when one of the 61 playing keys on either manual of the organ is depressed. As many as 9 frequencies representing the fundamental and 8 partials or harmonics connected to the contacts of this key are impressed on bus-bars connecting them to primary taps on a matching transformer. From the high-impedance secondary of this matching transformer the signal passes through a tremulant mechanism, a series of contacts introducing fixed resistors periodically to vary the amplitude of the signal, and then to the swell pedal which controls volume as the signal is fed into the audio amplifier.

The console preamplifier consists of 2 stages of amplification. A push-pull output transformer couples the low-impedance signal (run in cable to tone cabinet) to the power amplifier containing 2 stages of push-pull-parallel tubes driving a pair of 12-in. dynamic loudspeakers.

Reverberation control and the rotor tremulant, optional features of the tone cabinets, are also shown in the block diagram. Reverberation control is accomplished by an electromechanical system of springs suspended in tubes of oil and driven by a small dynamic unit. Delayed vibrations of the springs are picked up by a special crystal microphone and fed into the amplifier. The rotor tremulant consists of a motor-driven drum fitted with 2 deflecting vanes revolving in front of speakers mounted in a "V"-shaped baffle.

THE NOVACHORD

This instrument, complete with keyboard, generator, control panel, power supply, amplifier and loudspeakers, is built into a console occupying a 4 1/2 x 4 ft space. The Novachord is unique among musical instruments in that the player may control the "attack," or growth and decay characteristics, of the tone produced in addition to having available a wide range of effective tone qualities. Thus percussive tones like piano music are possible, and by operating simple controls the player changes to a singing tone comparable to a violin, or to a variety of other novel effects.

The tones of the Novachord originate in vacuum-tube oscillator and frequency-divider circuits, as indicated in the block diagram, Fig. 4, which shows the oscillator and dividers for note "A." There is a similar oscillator, with its associated divider circuits, for each of the other 11 notes of the scale. The 12 oscillators operate at the frequencies of the highest octave of the instrument.

Each frequency divider is a non-linear amplifier operating in such a way that its output signal has half the frequency of its input signal, and therefore the musical interval between 2 consecutive dividers is an octave. As the 5 "A" dividers are cascaded, they and the "A" oscillator supply 6 octaves of notes "A."

Associated with each oscillator and each divider is a control tube which acts as a valve operated by the corresponding playing key. Signals from the oscillators and dividers pass through the control tubes to the control box, where they are combined and modified by tone control circuits. The control box output is fed into a 2 stage preamplifier which drives a standard Hammond Organ power amplifier connected to two 12-in. dynamic loudspeakers.

Fig. 4. Schematic of Novachord

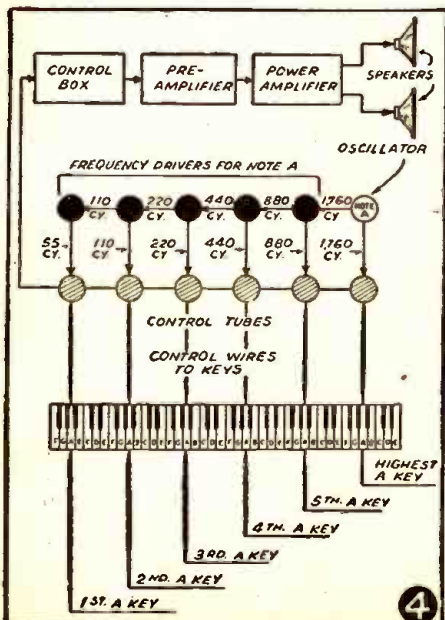

FREE TO RADIO-CRAFT READERS!

"Send Us Your Name—Get This Valuable Encyclopedia Volume

FREE!"

**No Strings!
No Catches!
NOTHING TO BUY!**

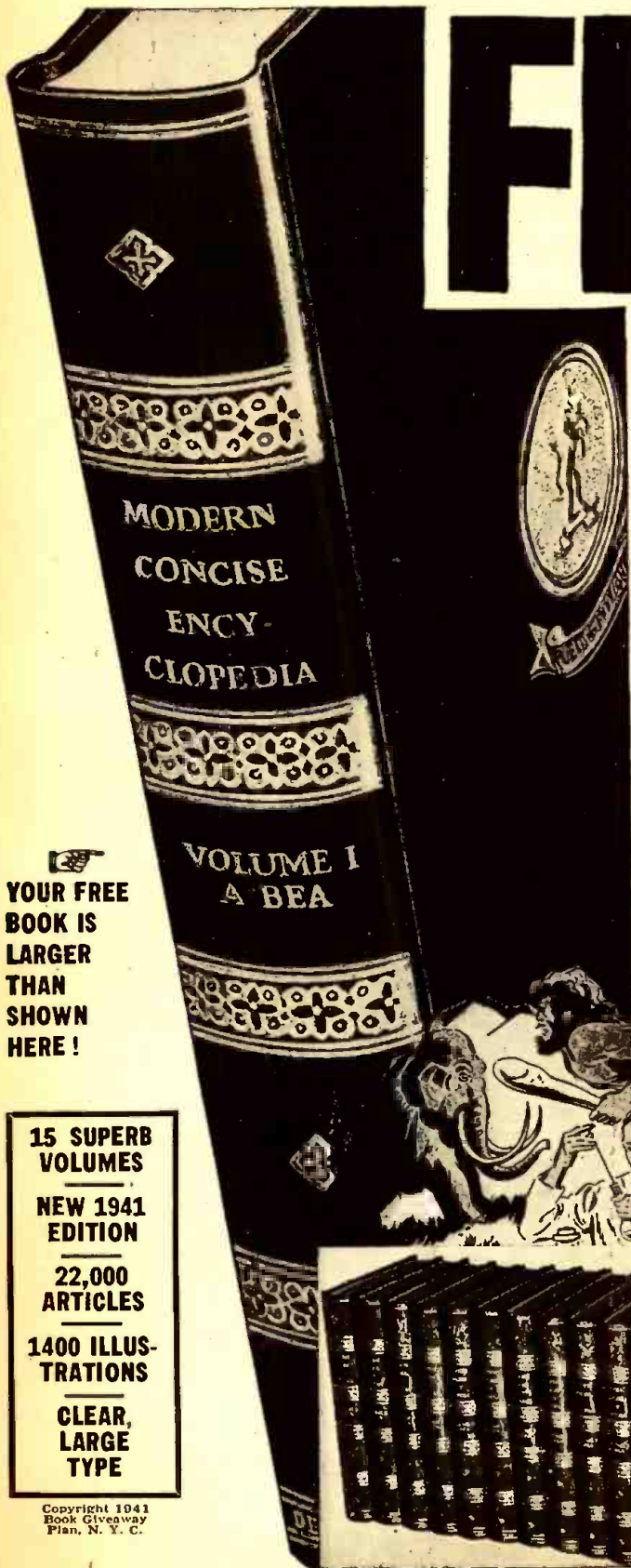

Yes, this volume is our outright gift! There is no obligation to do anything or buy anything. Simply mail the gift coupon below, and we send you Volume One of the Modern Concise Encyclopedia! We give it to you free—for the mailing charge—and after you examine it—you are given the privilege of accepting the rest of the big fifteen volume set almost as a gift.

FINEST CONCISE ENCYCLOPEDIA IN AMERICA!

Imagine! Through this sensational offer you can own the brand new edition of the finest set of concise encyclopedias in America! Books bigger than full library size, much larger than pictured, handsomely bound in deep green cloth, stamped in red, and gilded—expensively made volumes you will be proud to own—yours at next to no expense!

want to know, clearly written and illustrated. They are written for YOU—for the information you seek on History, Biography, Geography, Medicine, Industry, Music, Religion, and 22,000 MORE subjects—a rich mine of information providing more FACTS than a college education.

CHOICE OF DELUXE EDITION

One further privilege. If you prefer, you can have your set in the superb DeLuxe Edition pictured at left—bound in red artificial leather, stain and waterproof, embossed and gilded—distinguished volumes built for lifetime use, with extra heavy covers, woven head and tailbands, and many other DeLuxe features. There is NO EXTRA CHARGE FOR VOLUME ONE in DeLuxe Edition. You can have Volume One FREE in your choice of editions. However, the remaining 14 volumes in DeLuxe Edition because of the great expense of DeLuxe features, will cost you slightly more than Regular. Read the coupon very carefully before checking the edition you desire.

14 MORE BOOKS—ALMOST A GIFT!

You are also entitled to an EXTRA PRIVILEGE. We reserve in your name all the rest of the fourteen volumes. And—unless you cancel your reservation—you receive one every week, as they come off the presses. But you will not be charged for these volumes the high price they are worth—merely a PRIVILEGE PRICE—a price so small that every reader will know he is receiving the volumes PRACTICALLY AS A GIFT! Remember—these are genuine encyclopedias—books that contain EVERYTHING you ever

HOW TO GET YOUR FREE BOOK!

First read the Gift Coupon below. Then check whether you want Regular or DeLuxe. Mail coupon to us enclosing 10c coin and 3c stamp. We send you by return mail your free Volume One in the edition you desire. This book BELONGS TO YOU whether you want the rest of the set or not. We also reserve the rest of the 14 volumes in your name, and we give you the EXTRA

PRIVILEGE of receiving these volumes as they come off the presses—one book each week. And if you decide not to cancel reservation, you get these books by paying the postman the SPECIAL GIFT PRICE—only 49c per volume for Regular Edition or 79c for DeLuxe Edition, plus a few cents mailing charge—and NO MORE! Send in for your first free volume TODAY!

YOUR FREE BOOK IS LARGER THAN SHOWN HERE!

15 SUPERB VOLUMES

NEW 1941 EDITION

22,000 ARTICLES

1400 ILLUSTRATIONS

CLEAR, LARGE TYPE

Copyright 1941 Book Giveaway Plan, N. Y. C.

ACT NOW!

READERS GIFT COUPON

BOOK GIVE-AWAY PLAN

P. O. Box No. 56, Brooklyn, N. Y.

Enclose 10c in Coin and 3c Stamp to Cover Mailing Charge

Please send me free Volume One of the Modern Concise Encyclopedia in the edition checked below. I enclose 10c coin and 3c stamp to cover mailing charge on my free book.

Please also reserve the balance of a set in my name. After I examine my free Volume One I can cancel this reservation; otherwise you may send me the rest of the set at the rate of a volume a week, and I will pay the postman, C.O.D. the SPECIAL GIFT PRICE of only 49c per volume for Regular Edition, or 79c per volume for DeLuxe Edition (plus a few cents mailing charge). Volume One is mine to keep in any case.

Name

Address

City & State

Which Edition Regular { The 10c mailing charge is the SAME } RC
Do You Want? DeLuxe { charge for either edition }

How to make and use a

DIRECT-READING V.-T. VOLTMETER

"A Unique Instrument"

Dear Editor:

This letter accompanies an article concerning a common instrument, the Vacuum-Tube Voltmeter. However, this instrument is unique in 2 respects:

(1) The greatest disadvantage of home-made equipment is that it looks home-made. This is overcome by having the instrument characteristic match the scales of a standard foundation meter instead of home-made meter scales to suit the instrument.

(2) Instead of using the vacuum tube as a rectifier, it is used as a class A amplifier. I have seen this principle used in only one other V.-T.Vm. construction article to date.

Its other advantages include a high current sensitivity of 1 microampere for full-scale deflection; stability against line voltage variations without the use of voltage regulator tubes; its ability to withstand overloads of over 100 times; and, general stability with freedom from trouble.

The instrument itself is inherently a simple affair. As a result of this, it can be duplicated by various constructors with a minimum of trouble. All parts used are standard commercial components available at any jobber.

THE AUTHOR

STEPHEN J. VARMECKY



FIG. 1

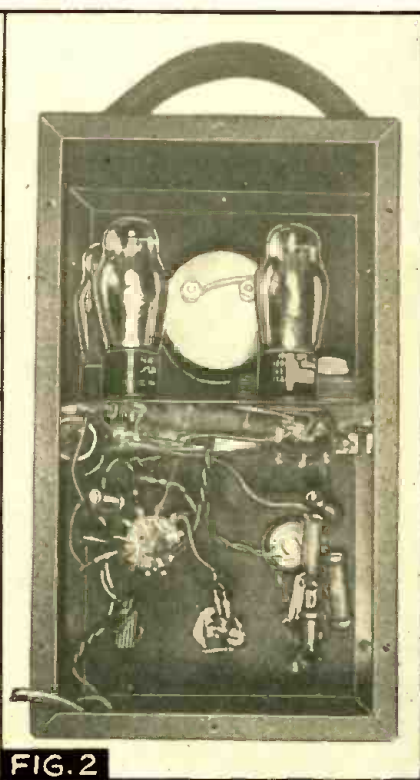

FIG. 2

← Front and rear views of the completed Direct-Reading V.-T. Voltmeter. This inexpensive instrument is easy to construct. The carrying case is a readily available type.

more, voltage may be measured at any point in the set, even on the grid of a tube, by touching the test prod to that point.

It has a sensitivity of 1,000,000 ohms/volt, but at all ranges above the 25-volt range the input impedance is essentially constant at 25 megohms.

Because of this high input impedance, many voltage measurements are made possible which are not ordinarily practicable with a moving-coil voltmeter. Grid bias obtained from a gridleak and condenser, for example, may easily be measured.

CONSTRUCTION

At current amateur net prices, the total cost of the instrument is about \$12, using all new parts.

The instrument is constructed entirely from easily-obtainable commercial parts. There are no critical components which lead to trouble if they are not set exactly right. It is designed so that it can be duplicated with a minimum of trouble by anyone else.

A steel cabinet, 6 x 7 x 12 ins., with a carrying handle houses the instrument. Although any type of case may be used, open chassis and panel construction is not recommended as the instrument will not be as portable or rugged.

Inside the cabinet is a chassis made from No. 18 gauge sheet metal with only 3 sides folded down and the back left open to make it more accessible. This can be seen in Fig. 2.

Any good 0-1 ma. foundation meter may be used as an indicating meter. It should have ranges of 0-1, 0-5, and 0-25 marked on the D.C. scales. Do not use the A.C. scales. Select this meter as you would select a wife—find one that you can stand to look at all day. In the author's model, a Beede model 541 fan-type meter was used.

The power transformer may be any 4- or 5-tube half-shell transformer with 6.3-volt filament windings, as the current drain is only three tubes on the filaments, and less than 15 ma. from the high voltage, a larger unit is unnecessary.

Because of the high resistances involved,

In spite of all the Vacuum-Tube Voltmeter construction articles which have appeared in various radio magazines from time to time, the V.-T.Vm. still does not have the popularity among Servicemen which is due it.

Perhaps the most important reasons for this is its limited utility and inconvenience. No Serviceman wishes to put his hard-earned cash and the sweat of his brow into a temperamental instrument just to measure an A.V.C. voltage when an "eye" tube can serve him well enough for this purpose.

ADVANTAGE

The fact that a V.-T.Vm. can measure A.V.C. and A.F.C. voltages is always mentioned in a V.-T.Vm. article. The real advantage of a V.-T.Vm. is that it measures potentials without loading the circuit, thus making possible the measurement of the normal operating voltage anywhere in a

receiver. Any Serviceman knows that the voltage on the plate of a 6Q7 tube, in a receiver, exceeds 5 or 10 volts; yet, that is all he expects to find if he measures it with a 1,000 ohms/volt meter.

Others may object to the V.-T.Vm. because it is too inconvenient to be useful. A slide-back V.-T.Vm., while it may be ideal for certain types of work, has no place on a service bench. Even a direct-reading instrument with calibration sheets is a time waster and a general pain in the neck.

The V.-T.Vm. described here overcomes these objections, as far as possible, while still retaining the advantage of a V.-T.Vm. The voltage is indicated directly on the meter—there is no reference to calibration sheets.

In operation, it is used just as a 1,000 ohms/volt meter with one exception; polarity is reversed by the flip of a switch instead of reversing the test prods. Further-

TEST INSTRUMENTS

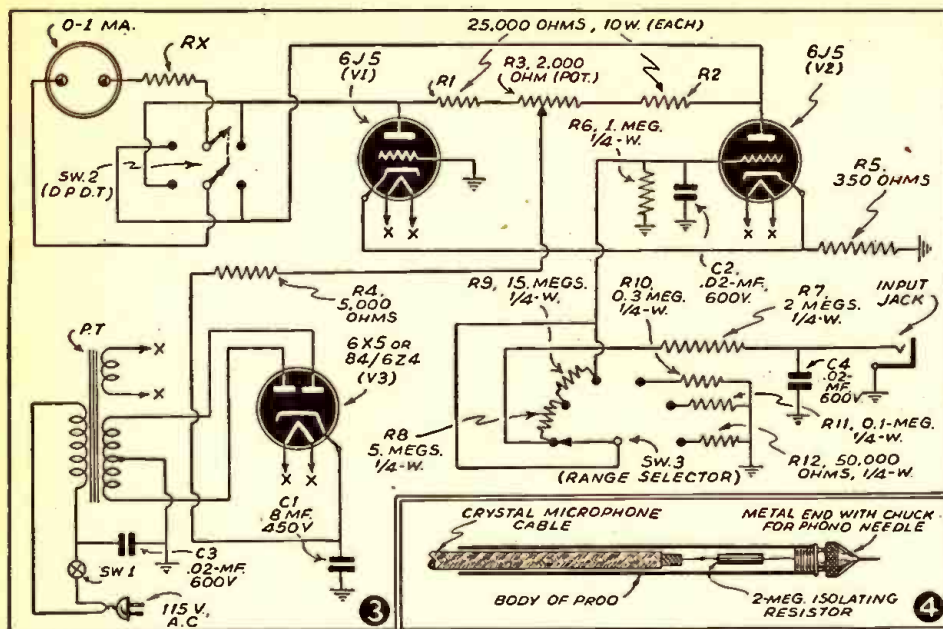

a low-loss range selector switch was at first considered necessary. Subsequent tests, however, proved that an ordinary tap-switch was entirely satisfactory. In the instrument shown, a particular 12-point rotary tap switch was used (see List of Parts) and no trouble was experienced with it. It should be of the shorting type.

In Fig. 3 resistors R1 and R2 are not critical with regard to exact resistance value, but they should both have the same resistance. These are 25,000-ohm, 10-watt wirewound units. Use 2 new resistors of reliable manufacture—not 1 new and 1 junkbox orphan, or 2 resistors that have seen better days. This is important.

The potentiometer is a 2,000-ohm wirewound control without taper. It should be completely insulated from the chassis.

Resistors R4 and R5 are the only other resistors which carry appreciable current, and these are not critical. Do NOT substitute other values, however, but get the values shown.

In constructing the instrument, mount all parts in their proper positions before wiring. The chassis is wired outside the cabinet first, leaving long leads for connection to the front panel. Resistors R5 and R6 and condensers C1, C2 and C3 are the only ones on the chassis.

ASSEMBLY

Place the chassis in the cabinet and secure it with two sheet metal screws through each side of the cabinet into the chassis.

The front panel should now be put in position and secured. It may now be wired and connected to the chassis. The leads which go to resistor Rx should be temporarily shorted. Do not connect any of the resistors on the range selector except R7, and condenser C4.

We are now ready for a preliminary test. With the rectifier tube (6X5G) in place, short both plate connections of the 6J5G tubes to chassis and apply the power.

Test the zero adjustment to see whether or not the meter may be brought to zero. If the meter cannot be brought to zero with R3, probably one of the resistors R1 or R2 is open, wrong value, or there is too much difference in resistance between them. Adjust this point before going on with the construction.

Remove the shorts from the 6J5G plate connections and insert two NEW 6J5G tubes. Use only new tubes of reliable manufacture. Allow the tubes to heat for at least two minutes and then set the meter to

zero with R3. If it cannot be brought to zero, try other tubes. Tubes which are so mismatched that they cannot be balanced, are unfit for use here.

With the meter at zero, try shorting resistor R6. A steady deflection of more than 10 or 15 microamperes indicates tube V2 has excessive gas content. Several tubes, when tested in this circuit, showed so much deflection that the author suspected that they were filled with compressed air.

Before going any farther, make the test prod as shown in Fig. 4. The test prod is the type having a chuck for a phono-needle. This metal end may be pulled out and the test prod re-assembled as shown in Fig. 4.

The crystal microphone cable terminates in a phone-plug, the shield connected to the body of the plug and the center wire to the tip. An extra wire is connected to the body of the plug, and terminates in a small alligator clip for connection to the chassis of a receiver under test.

At this point, any temporary wires or connections should be put in place permanently and all connections soldered. With all this in order, the instrument is ready for calibration.

The calibration of this V-T.V.m. is a simple matter. A source of high voltage D.C., about 250 volts with a voltage divider in the output is necessary. A multi-range D.C. voltmeter is also required. The D.C. voltmeter is connected across the output of the voltage divider, and the V-T.V.m. is connected across the terminals of the D.C. voltmeter, using the special test prod.

Insert an old volume control of about 50,000 ohms resistance in the place for resistor Rx. Before applying the power to the V-T.V.m., set the mechanical zero adjustment on the indicating meter to exactly zero. THIS IS IMPORTANT.

Apply the power to the V-T.V.m. and allow it to warm up for at least five minutes. Set the meter to zero with R3 and the range selector to the 0-5 volts position. Try throwing SW2 to the opposite position. If there is any deflection on the meter, the zero was not correctly set with R3. This must be set exactly during calibration. The voltage divider should be set to minimum voltage before the power is applied to the high voltage supply.

By means of the voltage divider, set the D.C. voltmeter to exactly five volts. If the V-T.V.m. reads backwards, throw SW2 to the opposite position.

Using the control at Rx, set the V-T.V.m.

until it indicates exactly full scale—5 volts. Then, WITHOUT CHANGING THE SETTING, remove the volume control from the circuit and measure with an ohmmeter the amount of resistance which was in the circuit. It will probably be near 25,000 ohms. Insert a one-watt resistor of this size at Rx, or, if it is an odd value, make up a resistance with several smaller units. This resistance is not unduly critical.

This finishes the calibration of the 5-volt range. Resistor R8, a 5-meg., 1/4-watt unit is now put in place. With the voltage divider set to give 10 volts at the D.C. voltmeter, set the V-T.V.m. to the 0-10 volts position and check the voltage indicated. If it does not indicate exactly full-scale—10 volts—resistor R8 is incorrect. Try other 5-meg. resistors or combinations until the correct value is found.

Repeat this procedure in the case of "resistor" R9. This is actually a combination consisting of a 5-meg. and a 10-meg. unit, in series, as a 15-meg. unit is not available. This completes the calibration of the 25-volt range.

In these 3 ranges, 0-5, 0-10, and 0-25 volts, resistance is added in series to extend the range at the rate of 1,000,000 ohms/volt. In the higher voltage ranges, the grid resistor is shunted so that the grid takes a smaller proportion of the applied voltage with the total input impedance essentially constant at 25 megohms.

If R7, R8, or R9 has excessive resistance, the readings given on the V-T.V.m. will be low; if the resistance of R10, R11, or R12 is excessive, the readings on the V-T.V.m. will be high. Bear this in mind during calibration.

Continue the calibration at the 0-100-, 0-250-, and 0-500-volt ranges as before. The 0-500 volt range may be calibrated at 250 volts, the V-T.V.m. adjusted to indicate exactly half-scale.

During calibration there are 2 important factors to remember. (1) The V-T.V.m. MUST be exactly at zero. If reversing SW2 when no voltage is applied to the V-T.V.m. causes a deflection, the meter is not correctly zeroed.

(2) Do not remove the D.C. voltmeter while calibrating the V-T.V.m. Removal of this meter will alter the voltage at the V-T.V.m. and make the calibration worthless.

It may seem at first from this article that the instrument is a critical affair. This is not the case. If all new parts of reliable manufacture are used in the construction of the instrument, no trouble should be encountered. Troubles which might occur are given just in case it decides to be stubborn. A little mathematical figuring will show that at worst, not more than 10 milliamperes could flow through the meter. This would be the case only if Rx were shorted, R2 burned open, and V2 were internally shorted, plate to cathode. Unless some component fails, not more than 5 milliamperes can flow through the meter regardless of overload. Thus, under ordinary conditions, it is impossible to burn-out the meter.

OPERATION

Thus far the construction of the V-T.V.m. de luxe was described. The ease of operation of this V-T.V.m., along with other desirable characteristics, makes possible many very useful tests which are not ordinarily possible.

There are several characteristics which should be kept in mind when using this meter. The instrument will respond only to D.C. potentials. Only D.C. voltages will be indicated, regardless of the presence of A.C. voltages.

Don't be afraid to use this instrument. Regardless of overload, the meter cannot be damaged, although the needle may be bent from hammering it off-scale excessively! It may be subjected to 500 volts while in the 0-5 volts position without harm, 100 times overload.

Its scales are perfectly linear to more than twice the scales of the meter. This is proved by the fact that the same reading will be obtained whether the probe is positive or negative, on any given voltage. In other words, the scale calibration is identical regardless of polarity.

In spite of the fact that no voltage regulator tubes are used, there will be no drift from zero because of line voltage variations. This stability is obtained by using a separate tube to balance-out the static plate current of the voltmeter tube. Both tubes are operated under identical conditions and any change in plate voltage will affect the current in both tubes by the same amount. The exact plate current drawn by each tube is unimportant; it is the difference in plate currents which the meter indicates.

Grid current is held to a very low value, the maximum drift possible being about 1%. Ordinarily there will be no noticeable drift off zero from the lowest to the highest voltage range, a change of from 1 megohm to 10,000 ohms in the grid circuit.

THE ABC'S OF A.V.C.

A.V.C. voltage may be measured at any point where it exists: the grid of any controlled tube, the A.V.C. bus, or the diode plates of the 2nd-detector. It can be followed through the receiver, unaffected by the presence of the meter in the circuit.

This makes it useful in testing for defects in the A.V.C. circuit. Low A.V.C. on strong locals will generally be due to a short in the A.V.C. system, or a lack of gain because of misalignment, weak tubes, etc. A high A.V.C. voltage, with no signal input is caused by oscillation in the R.F. or I.F. stages of the receiver. Extreme variations of A.V.C. voltage with modulation are caused by insufficient A.V.C. filtering and may be the cause of distortion or lack of response to low audio frequencies.

The V.-T.Vm. can be used as an alignment indicator. This is done by setting the trimmers for maximum A.V.C. voltage. A fairly strong signal should be used, enough to give a good deflection on the V.-T.Vm. It is not necessary to connect to the A.V.C. bus; the grid of any A.V.C.-controlled tube will do.

This is also useful when setting electrical pushbutton tuning. The adjustments are peaked on the station desired, using the V.-T.Vm. as an alignment indicator.

It is a good idea to remember the approximate A.V.C. voltage developed by common receivers on a local station. This will quickly show whether or not the receiver is up to par. It is not necessary to remove the chassis from the cabinet to check this, again, the grid cap of any controlled tube serves for measurement.

A skeptic customer can be shown the effect of a new tube by the increase in A.V.C. voltage. He may not know what it is all about, but he can see that the meter reads higher when a new R.F., I.F., or converter tube is substituted for a weak one.

This may be used to check converter tubes, which, although they show good emission, may not work well as converters.

In common receivers only A.V.C. voltage will be found from control-grid to chassis. Total grid bias, both A.V.C. and cathode bias, will be found from control-grid to cathode.

A NEW BOOK TO ADD TO YOUR TECHNICAL LIBRARY
AUTOMOBILE RADIO — Principles & Practice

by B. Baker Bryant

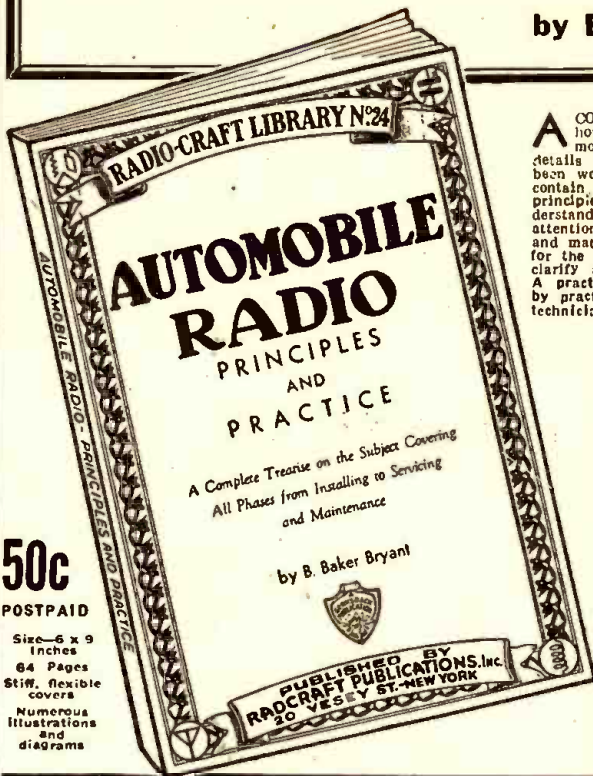

A COMPLETE compilation of pertinent data on how to install and service the modern automobile radio receiver. All of the non-essential details which have crept into the profession have been weeded out. Each topic is treated so as to contain a precise statement of the fundamental principle involved, to assure the reader's clear understanding of this principle, without distracting his attention by the discussion of a multitude of details and mathematical expressions, which are primarily for the engineer, and tend to confuse rather than clarify a statement for the auto-radio-technician. A practical treatise based on practical experience by practical radio people for the practical radio-technician.

Brief Outline of Contents—

Introduction—The Auto-Radio Art.
Features of the Modern Automobile Receiver.
Installations of Automobile Radios and Antenna.
The Automobile High and Low Tension Electrical Systems.
Automobile Electrical Disturbances.
Vibrator Converters and Motor Generators.
Service Hints. Classified Automobile Installation Notes, and Conclusion.

Send 50c check, money order, unused U. S. stamps, or coin for your copy of "Automobile Radio—Principles & Practice"—it will be sent to you postpaid upon receipt of your remittance.

RAD-CRAFT PUBLICATIONS, Inc.
20 Vesey Street, New York, N. Y.

FREE!

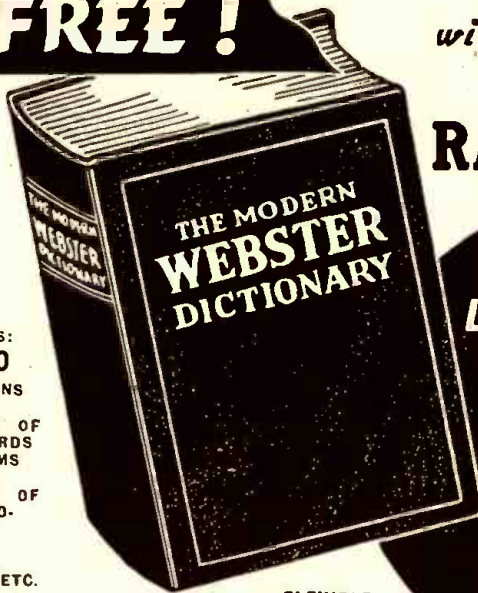

CONTAINS:
22,000
DEFINITIONS
•
DICTIONARY OF
RADIO WORDS
AND TERMS
•
DICTIONARY OF
THE AUTO-
MOBILE
•
TABLES,
TREATISES, ETC.

FLEXIBLE
IMITATION
LEATHERETTE
COVER, SIZE 5 1/2"x8"

with \$1.00 subscription
to
RADIO-CRAFT

FULL
LIBRARY SIZE
**MODERN
WEBSTER
DICTIONARY**
**416
PAGES**

FILL OUT—MAIL THIS COUPON TODAY!

RADIO-CRAFT, 20 Vesey Street, New York, N. Y.
Gentlemen: Enclosed you will find One Dollar for which enter my subscription to RADIO & TELEVISION Magazine for Eight Months. Send me ABSOLUTELY FREE and POST-PAID, my copy of the MODERN WEBSTER DICTIONARY.
 This is a New Order Extend my present subscription

Name

Address

City State RC-1041

(Remit by check or money order; register letter if you send cash or unused U.S. Postage Stamps)

If you will take advantage NOW of our special subscription offer of eight months for \$1.00, we will send you ABSOLUTELY FREE and POST-PAID this 416 page full library size MODERN WEBSTER DICTIONARY—useful and instructive to everyone. This self-pronouncing authoritative dictionary—a new work throughout—contains the most up-to-date words now in common use, 22,000 definitions in all. It also features a Glossary of Radio Words and Terms, Dictionary of the Automobile, Treatises on Practical Syntax, Etymology, Punctuation and Standard English by well known authorities, Metric Tables, Time, State Flowers, National Parks of the U. S., etc.

This is a time limited offer. so don't delay in returning the Coupon.

RADIO-CRAFT
20 VESEY STREET NEW YORK CITY

• TEST INSTRUMENTS •

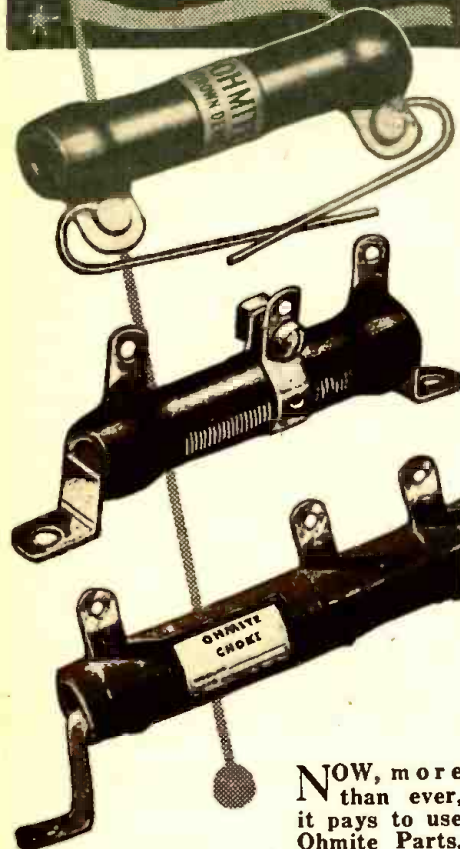
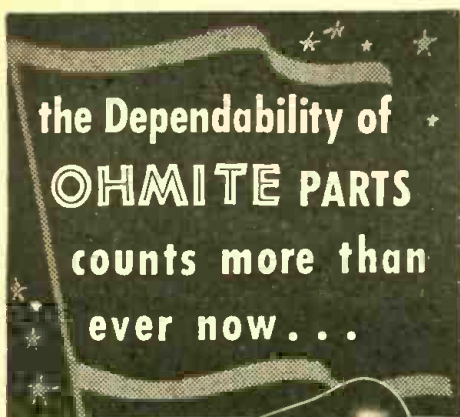

NOW, more than ever, it pays to use Ohmite Parts, because you can depend on them to give trouble-free service and prevent costly breakdowns. Ohmite Brown Devils are available in convenient 10 and 20 watt sizes, in many stock resistance values. Ohmite Dividohm Adjustable Resistors are handier than ever for quick replacements or change of resistance values. Sizes from 10 watts to 200 watts. Ohmite Power Line Chokes prevent R.F. current from interfering with radio receivers.

Get Them at Your Jobber



Send Coupon and 10c for New Ohmite Ohm's Law Calculator.

OHMITE MANUFACTURING CO.
4894 Flournoy Street, Chicago, Ill.

10c in Coin enclosed. Send Ohm's Law Calculator.

Name

Address

City State

Occupation

Radio-Craft Oct. '41

OHMITE

RHEOSTATS RESISTORS TAP SWITCHES

OSCILLATOR BIAS

Oscillator grid bias, obtained by the grid-leak-and-condenser method, is measured at the control-grid of the oscillator tube. In a pentagrid converter, this is the *oscillator grid* or grid No. 1. There will be a slight detuning, but a small adjustment of the tuning condenser will take care of this. The presence of grid bias here indicates that the oscillator is functioning.

Measure the bias at the high-frequency end of the dial first, then, with the V.-T.Vm. still connected, turn the tuning condenser to the low-frequency end. A sizeable drop indicates weaker oscillation at this end of the dial. This causes a loss of sensitivity at the low-frequency end of the band.

A new converter tube should be tried, even though the old one tests good. The resistance of the gridleak may have changed, or there may be insufficient voltage on the plate or anode grid. Too small a tickler coil, insufficient coupling, or shorted turns in the oscillator coil can also cause this. Common receivers will have about 15 volts gridleak bias on the broadcast band, with not more than about 3 volts drop at the low-frequency end of the band.

A WOLF IN WAXED PAPER

The coupling condenser is the most critical condenser in a receiver from a leakage standpoint. A bypass condenser can get away with murder, but if a coupling condenser lets a few little D.C. volts go through it the set sounds like a demagnetized tin can.

Leakages, in a coupling condenser, of about 10 megohms are often sufficient to drive the control-grid of the following tube positive. Since it is necessary to disconnect the condenser, and the test must be made with a high-range ohmmeter, Servicemen do not check this condenser unless there is very definite reason to believe it is leaky. If the output tube is weak while the other tubes still show good emission, or if there is a lack of bass response, be sure to check the coupling condenser.

By means of the V.-T.Vm., this condenser can easily be tested with no more effort than removing the tube. Remove the tube following the coupling condenser and measure the voltage at each end of the grid resistor with respect to chassis. **IF THE VOLTAGE ON THE GRID END OF THIS RESISTOR IS MORE POSITIVE (i.e., less negative) THAN THE CHASSIS END, THERE IS LEAKAGE.** In a cathode bias circuit the voltage is zero at the chassis end of this resistor. With a 0.5-meg. grid resistor, and an operating voltage of 150 volts on the plate of the preceding tube, a leakage of 75 megohms will put +1 volt on the grid end of this resistor.

GENERAL MEASUREMENTS

The D.C. voltages may be measured at any point where they exist. The meter can be used in place of an ordinary moving-coil voltmeter, anywhere in a receiver.

Plate voltages, particularly in resistance-capacity coupled amplifier stages are measured under actual operating conditions.

Screen-grid voltages obtained through a single dropping resistor are also measured as actual operating voltages, not voltages under load.

When measuring actual tube voltages, measurements should be made with the ground clip connected to the cathode of the tube. In this way, only the potentials actually across the tube are measured. This must be done in order to measure cathode bias, as the voltage from grid to chassis is zero.

As this V.-T.Vm. has an input resistance of 1 megohm-per-volt, it requires 1 micro-ampere for full-scale deflection.

The lowest-drain tubes take about 0.1-milliamperes or 100 microamperes. With the V.-T.Vm. adding about 5 microamperes to this, the change in load is very small.

This instrument has been designed to be used constantly, not set aside for special jobs. The tubes are operated at about half their ratings, so that the instrument can be left on for hours at a time without harm. Once you get used to using it, you'll never be satisfied with a 1,000 ohms/volt meter again.

LIST OF PARTS

RESISTORS

- Two I.R.C., Type AB 25,000 ohms, 10 W., wirewound, R1, R2;
- One I.R.C., Type W-2,000, 2,000-ohm potentiometer, wirewound, R3;
- One I.R.C., Type AB, 5,000 ohms, 10 W., wirewound, R4;
- One I.R.C., Type AB, 350 ohms, 10 W., wirewound, R5;
- One I.R.C., Type BT 1/2, 1 meg., 1/4-W., R6;
- One I.R.C., Type BT 1/2, 2 megs., 1/4-W., R7;
- One I.R.C., Type BT 1/2, 5 megs., 1/4-W., R8;
- One I.R.C., Type BT 1/2, 15 megs. (10 megs. & 5 megs.), 1/4-W., R9;
- One I.R.C., Type BT 1/2, 0.3-meg., 1/4-W., R10;
- One I.R.C., Type BT 1/2, 0.1-meg., 1/4-W., R11;
- One I.R.C., Type BT 1/2, 50,000 ohms, 1/4-W., R12.

CONDENSERS

- One National Union type CM-8450, 8 mf., 450 V., C1;
- Three National Union type T-6-2, 0.02-mf., 600 V., C2, C3, C4.

TUBES

- Two National Union, 6J5, V1, V2;
- One National Union, V3, 6x5 or 84/6Z4.

MISCELLANEOUS

- One Bud single-pole, single-throw switch, Sw.1;
- One Bud double-pole, double-throw switch, Sw.2;
- One Beede model 541 0-1 ma. meter;
- One Thordarson T-70R20 power transformer, P.T.;
- One Mallory-Yaxley midget phone jack;
- One Mallory-Yaxley phone plug, type 75;
- One Mallory-Yaxley type 3100-J rotary tap switch, Sw.3;
- Three Amphenol type RS-8 sockets;
- Two Mallory-Yaxley type 462, etched dial plates;
- Two bar knobs;
- Power cord & plug;
- Needle-tip test-prod;
- One Bud metal cabinet type 1096, 6x7x12 ins.

"POCKETRACER" SIGNAL GENERATOR

Radex Corporation

1733 Milwaukee Ave., Chicago, Ill.

A PEN-TYPE signal generator which puts out a universal-type signal suitable for general service work. According to the manufacturer, it is an R.F. and I.F. signal source of the multivibrator type (a signal rich in harmonics) which can be used for alignment or test purposes. It uses a single pen-like type of flashlight battery from which it draws a total current of only 150 milliamperes.—Radio-Craft

3-WAY PERSONAL PORTABLE

Fada Radio & Electric Co., Inc.
30-20 Thomson Ave., Long Island City,
New York



A NEAT personal portable which weighs only 6 1/4 lbs. Frequency range: 538 to I.F. units; miniature-type tubes; Hi-Q built-in loop antenna; automatic battery switch on door; 4 1/2-in. P.M. dynamic speaker; automatic volume control; and a sensitive superhet. circuit. Average battery operation, 40 hours. Measures 9 x 6 x 4 ins.—

Other features: double-tuned iron-core I. F. Transformers. Set operates from batteries or from A.C./D.C. lines.—Radio-Craft

BARRIER TERMINAL STRIPS

Howard B. Jones
2300 Webansia Ave., Chicago, Ill.

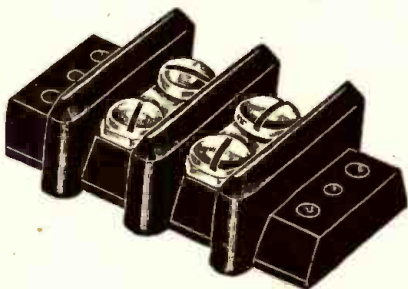

THE body of these strips is of heavy molded Bakelite with barriers between each set of terminals. These barriers provide maximum metal-to-metal spacing, and prevent direct shorts from frayed wires at the terminals. Known as the 150 series they comprise 3 sizes. The type 150 have 10/32 screws with 3/4-in. metal-to-metal spacing, type 152 have 1/4-in./28 screws, with 1-in. metal spacing.—Radio-Craft

CORRECTION: "PORTABLE DISC RECORDER" IS ALL-PURPOSE SOUND SYSTEM

RCA Manufacturing Co., Inc.
Camden, N. J.

LAST month, in the Latest in Radio Department, pg. 185, Radio-Craft ran an illustration of a different item than the RCA type OR-1 Portable Disc Recorder partly described in the text which accompanied the view. The OR-1 Recorder is correctly illustrated above and is described as follows:

This 12-watt deluxe instrument is designed for radio, studio or "location" work and is contained in 2 portable cases. This portable unit is a complete recorder with the exception of a microphone. It consists of a turntable, a record-cutting attachment, an amplifier, and a loudspeaker unit.

This turntable and the amplifier may be used together as a high-quality record player. The aluminum 16-in. turntable is rim-

driven; dual driver wheels virtually eliminate slippage. The off-on switch also releases both driver wheels to prevent "flats" from developing in the rubber. Turntable speeds are 78 and 33 1/3 r.p.m.

The frequency response of the diamond-point pickup is said to be uniform between 30 and 10,000 cycles. This pickup reproduces either laterally- or vertically-cut records, as desired; several filters provide for properly reproducing the particular kind of record being used. A switch selects the desired filter.

The recording attachment includes a spiraling handwheel and a 6,000-cycle cutting head. The 12-watt amplifier operates on 115 V., A.C.; gain is 105 db.; frequency response, 30 to 15,000 cycles ± 2 db.; noise

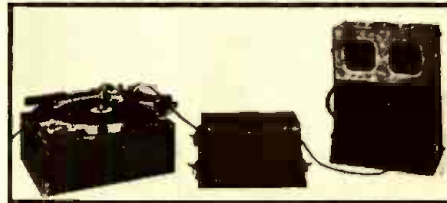

level is -60 db. below signal; distortion, under 3% r.m.s. at full output between 50 and 7,000 cycles.

The 2 accordion-edge loudspeakers mounted in the removable lid are enclosed in a sealed compartment for proper cone loading and frequency response. Headphone record monitoring and several accessories designed for this unit are available.

The unit illustrated in September Radio-Craft was the RCA 15-watt All-Purpose Sound System, a compact unit ideal for mobile or permanent installation. This Sound System operates from 115 V. A.C. or, with very low drain, from a 6 V. storage battery. A turntable is mounted atop the case in conjunction with a high-quality crystal pickup. Tone and volume controls are provided. It may be used with a wide selection of loudspeakers and high-impedance microphones to fill individual requirements. It is considered ideal by the makers for such uses as in sound trucks, advertising, amusement parks, parades, sport events, political meetings, fairs, carnivals, sales campaigns, and picnics. Light in weight; measures 16 1/2 x 12 x 12 ins. high.—Radio-Craft

ECHOPHONE COMMUNICATIONS RECEIVER

Echophone Radio Co.
201 E. 26 St., Chicago, Ill.



MODEL EC03 is an 8-tube (including ballast), 12-control communications-type receiver in the lower-price bracket. Among its features are a tuned-R.F. switch on all bands, continuous coverage from 545 kc. to 30.5 mc.; crystal filter, 4 degrees of selectivity including 2 in which the crystal filter is in the circuit; crystal phasing control (for maximum interfering-signal reduction); automatic noise limiter with switch; phone tip-jacks; speaker - phones switch; speaker-phone switch; beat-frequency oscillator with variable-pitch control; external P.M. speaker in matching cabinet; electrical band-spread with calibrations for 4 ham bands but usable anywhere in the receiver's tuning range. Unique monitor circuit enables the ham to listen to his own C.W. transmissions. Operates on 115 A.C./D.C. V. line.—Radio-Craft

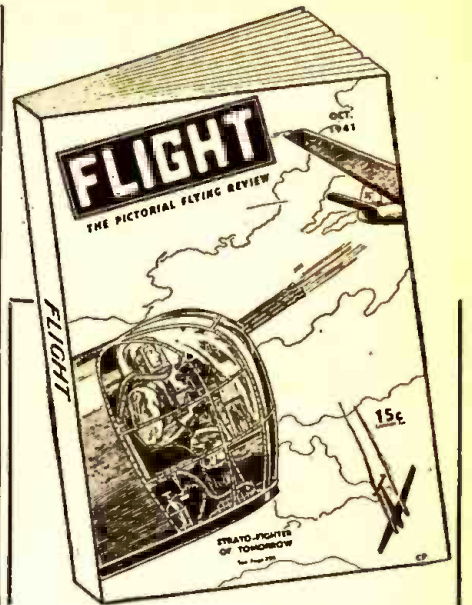

FLIGHT THE PICTORIAL FLYING REVIEW

Brings you all the phases of world aviation and aeronautics in a non-technical yet educational manner—exciting articles which catch your breath, yet give you the fundamentals of flying and ALL related subjects. FLIGHT keeps you abreast of all the major developments as fast as they appear anywhere. Now, when planes and flying are of vital importance to all, you just can't do without this highly absorbing yet instructive publication. You must be "in the know."

Partial Contents of the October ISSUE:

FLIGHT ARTICLES
Section View of Henschel (Nazi) Monoplane. "Strato-Fighters" of Tomorrow! "Royal Oak" British Aircraft Carrier—Sectional View. Section View of the British "Lysander." Aviation Engines—by Lt. Col. Victor Page, famous authority. Bombers vs. Fighters "Explosive" Rivets. 5-Gun Turboprop. Warplane Propellers. Question Box. FLIGHT DIGEST.

Attractive three-color cover, numerous illustrations. **15¢** copy

Send 10¢ for a Sample Copy.

Subscription price \$1.50 a year, Canada and foreign \$2.00.

FLIGHT MAGAZINE, 20 R Vesey St., New York, N.Y.



ELEMENTARY MATHEMATICS

EASY — SIMPLIFIED — PRACTICAL
HERE is a book for the business man, the technician and craftsman explaining and answering every operation and meaning with interesting illustrations and examples.

It is the key to a simple understanding of many perplexing problems in daily life. In clear, positive and definite language, the author popularizes and clarifies every subject and helps the reader to overcome any apparent difficulty in the study of mathematics.

A real home study-course in mathematics for the student or the man who wants to achieve proficiency or desires to brush-up on his knowledge.

Entire Chapter on Special Mathematics for the Radio Technician

CONTENTS OF BOOK

- CHAPTER I. Arithmetic—Addition—Subtraction—Multiplication—Division.
- CHAPTER II. Fractions and Cancellation—Fractions—Decimals—Percentage—Ratio—and Proportion.
- CHAPTER III. The Metric System.
- CHAPTER IV. How to Measure Surfaces and Capacity (Geometry).
- CHAPTER V. Powers and Involutions—Roots and Evolution.
- CHAPTER VI. Mathematics for the Manual and Technical Craftsman — Thermometer conversions — Graphs or Curve Plotting—Logarithms —Use of the Slide Rule.
- CHAPTER VII. Special Mathematics for the Radio Technician.
- CHAPTER VIII. Commercial Calculations — Interest — Discounts — Short Cut Arithmetic.
- CHAPTER IX. Weights and Measures—Useful Tables.

ONLY **50¢** POSTPAID

Send Stamps, Cash or Money Order. "Elementary Mathematics" can be carried readily in your pocket.

TECHNIFAX

1917 S. State St. RC-1041 Chicago, Ill.

SOLAR RED-CAPS

Smaller Diameter Dry Electrolytics

SPEED Servicing.



Write for Catalog SOLAR MFG. CORP. Bayonne, New Jersey

Where to Buy It! —

CLASSIFIED RADIO DIRECTORY

Handy Buying Guide, by Products and Companies' Names and Addresses, for the entire Radio Industry

Presented here is Section VII of the completely revised Second Edition of the CLASSIFIED RADIO DIRECTORY. This concludes the Directory. See the preceding issue and the listing in the August issue, for complete index to classifications and the respective issues in which they appeared.

This DIRECTORY is published in sections—1 section per month. This method of publication permits the DIRECTORY to be constantly up-to-date since necessary revisions and corrections can be made monthly. All names preceded by an asterisk (*) indicate that they are trade names.

If you cannot find any item or manufacturer in this section or in previously-published sections, just drop us a line for the information. Canadian radio manufacturers are unable to purchase any merchandise from the States, Radio-Craft is advised. Our readers, however, may wish to make Canadian purchases, and hence, current listings are being continued.

While every precaution is taken to insure accuracy, Radio-Craft cannot guarantee against the possibility of occasional errors and omissions in the preparation of this Classified Directory. Manufacturers and readers are urged to report all errors and omissions at the earliest moment to insure corrections in the very next issue.

LITERATURE

Nature of Publication

Catalog	C
Data Book	DB
House Organ	HO
Available to	
Anyone (being all-inclusive, no other listings are given, if "A" is indicated)	A
Amateurs (licensed radio)	AR
Dealers	D
Distributors	DIS
Engineers	E
General Experimenters	G
Jobbers	J
Manufacturers	M
Plane Pilots	P
Servicemen	S
Sound Specialists	SS

ABC RADIO LABS., 3334 W. New Jersey St., Indianapolis, Ind.—C: D, M, S, SS
 THE ACME ELECTRIC & MFG. CO., Water St., Cuba, N. Y.—C: A
 ACOUSTIC CONSULTANTS, INC., 1270 6th Ave., New York, N. Y.—C: AR, D, E, G, M, S, SS
 ACRO TOOL & DIE WORKS, 2815 Montrose Ave., Chicago, Ill.—C: D, E, MI, S
 H. W. AXTON CO., INC., 370 7th Ave., New York, N. Y.—C: D, M, SS
 ADVANCE ELECTRIC CO., 1260 W. 2nd St., Los Angeles, Calif.—C: A
 AEROVOX CORPORATION, New Bedford, Mass.—C: HO: AR, D, E, G, M, S, SS
 ALDEN PRODUCTS CO., 715 Center St., Brockton, Mass.—C: E, M
 ALLEN ELECTRIC & EQUIPMENT CO., 2101-2117 N. Picher St., Kalamazoo, Mich.—C: D, S
 ALLIED ENGINEERING INSTITUTE, 85 Warren St., New York, N. Y.—C: A
 ALLIED RADIO CORP., 833 W. Jackson Blvd., Chicago, Ill.—C: AR, D, E, G, M, S, SS
 ALLISON BAFFLE CO., 722 Berea Ave., Gadsden, Ala.—HO: SS
 ALOHA MUSICAL INSTRUMENT & PUBLISHING CO., 807 W. 79th St., Chicago, Ill.—C: D
 ALPHA WIRE CORP., 50 Howard St., New York, N. Y.—C: A
 AMERICAN COMMUNICATIONS CORP., 123 Liberty St., New York, N. Y.—C: A
 AMERICAN CONDENSER CORP., 2508 S. Michigan Ave., Chicago, Ill.—C: AR, D, E, G, M, S, SS
 AMERICAN EMBLEM CO., INC., Utica, N. Y.—C: AR, D, E, M, S
 AMERICAN GAS ACCUMULATOR CO., 1029 Newark Ave., Newark, N. J.—C: A
 AMERICAN LAVA CORP., Cherokee Blvd. & Manufacturers Rd., Chattanooga, Tenn.—C: E, M
 AMERICAN LEADER PRODUCTS CO., 8450 S. Ashland, Chicago, Ill.—C: D
 AMERICAN MICROPHONE CO., INC., 1915 S. Western Ave., Los Angeles, Calif.—C: A
 AMERICAN PHENOLIC CORP., 1250 W. Van Buren St., Chicago, Ill.—C: HO: A
 AMERICAN RADIO HDW. CO., INC., 476 Broadway, New York, N. Y.—C: A
 THE AMERICAN ROLLING MILL CO., Middletown, Ohio—C: E, M
 AMERICAN SWISS FILES & TOOL CO., 410 Trumbull St., Elizabeth, N. J.—C: D, E, M, SS
 AMERICAN TELEVISION & RADIO CO., 300 E. 4th St., St. Paul, Minn.—C: A
 AMPERITE COMPANY, 561 Broadway, New York, N. Y.—C: A
 AMPLIFIER CO. OF AMERICA, 37 W. 20th St., New York, N. Y.—C: A
 AMPRO CORPORATION, 2839 N. Western Ave., Chicago, Ill.—C: AR, D, E, G, M, S, SS

AMY, ACEVES & KING, INC., 11 W. 42nd St., New York, N. Y.—C: D, E, M, S
 ANSLEY RADIO CORP., 4377 Bronx Blvd., New York, N. Y.—C: D
 APPROVED TECHNICAL APPARATUS CO., 123 Liberty St., New York, N. Y.—C: A
 ARCO TUBE CO., 227 Central Ave., Newark, N. J.—C: A
 ARLAVOX MANUFACTURING CO., 430 S. Green St., Chicago, Ill.—C: D, E, M
 ARROW HART & HEGEMAN ELEC. CO., 103 Hawthorn St., Hartford, Conn.—C: M
 ASSOCIATED RESEARCH, INC., 431 S. Dearborn St., Chicago, Ill.—C: A
 ASTATIC MICROPHONE LAB., INC., 830 Market St., Youngstown, Ohio—C: A
 ATLAS CONDENSER PRODUCTS CO., 548 Westchester Ave., New York, N. Y.—C: D, M
 ATLAS PRESS CO., Kalamazoo, Mich.—C: A
 ATLAS SOUND CORP., 1447-39th St., Brooklyn, N. Y.—C: A
 AUDAK COMPANY, 500 5th Ave., New York, N. Y.—C: A
 AUDIO DEVELOPMENT CO., 123 Bryant Ave. N., Minneapolis, Minn.—C: E, M
 AUDIO DEVICES, INC., 1600 Broadway, New York, N. Y.—C: D, E, G, M, S, SS
 AUDIOGRAPH SOUND SYSTEMS, 1313 W. Randolph St., Chicago, Ill.—C: HO: D, E, S, SS
 AUTOCRAT RADIO CO., 3855 N. Hamilton Ave., Chicago, Ill.—C: A
 THE AUTOMATIC ELECTRICAL DEVICES CO., 324 E. 3rd St., Cincinnati, Ohio—C: A
 BAKELITE CORPORATION, 30 E. 42nd St., New York, N. Y.—C: HO: E, M
 BAKER & CO., INC., 113 Astor St., Newark, N. J.—C: A
 BANK'S MANUFACTURING CO., 5019 N. Winthrop Ave., Chicago, Ill.—C: D, E, M, S, SS
 BARKER & WILLIAMSON, Ardmore, Penna.—C: D, E, M
 BELDEN MANUFACTURING CO., 4647 W. Van Buren St., Chicago, Ill.—C: A
 BELL & HOWELL CO., 1801 Larchmont Ave., Chicago, Ill.—C: HO: A
 BELL SOUND SYSTEMS, INC., 1183 Essex Ave., Columbus, Ohio—C: A
 BELMONT RADIO CORP., 1257 Fullerton Ave., Chicago, Ill.—C: D
 BENTLEY, HARRIS MFG. CO., Conshohocken, Pa.—C: A
 THE BENWOOD-LINZE CO., 1838 Washington Ave., St. Louis, Mo.—C: E, M
 BILHORN BROS. ORGAN CO., INC., 1414 McLean Ave., Chicago, Ill.—C: A
 BIRNBACH RADIO CO., INC., 145 Hudson St., New York, N. Y.—C: A
 A. BITTER CONSTRUCTION CORP., 27-01 Bridge Plaza N., L. I. City, N. Y.—C: D
 THE BLAKISTON COMPANY, 1012 Walnut St., Phila., Pa.—C: A
 BLAW-KNOX COMPANY, Pittsburgh, Pa.—C: M
 BLILEY ELECTRIC CO., 200 Union Station Bldg., Erie, Pa.—C: A, HO: to regular Bliley distributors only
 THE "BLUE WIZARD" COMPANY, 2431 E. Slauson Ave., Huntington Park, Calif.—C: A
 DAVID BOGEN CO., 663 Broadway, New York, N. Y.—C: A
 BOND ELECTRIC CORP., DIV. OF WESTERN CARTRIDGE CO., 275 Winchester Ave., New Haven, Conn.—C: D
 BOND PRODUCTS CO., 13139 Hamilton Ave., Detroit, Mich.—C: D, E, M
 BOONTON MOLDING CO., 326 Myrtle Ave., Boonton, N. J.—C: E, M
 BOONTON RADIO CORP., P. O. Box 390, Boonton, N. J.—C: E, G, M
 L. S. BRACH MFG. CORP., 55 Dickerson St., Newark, N. J.—C: A
 BRETING RADIO MFG. CO., 1815 Venice Blvd., Los Angeles, Calif.—C: AR, D
 BRIGHT STAR BATTERY CO., Crooks & Getty Aves., Clifton, N. J.—C: A

BROWN MANUFACTURING CO., 403 W. Baltimore, Detroit, Mich.—C: A
 BROWNING LABORATORIES, INC., 750 Main St., Winchester, Mass.—C: A
 THE BRUSH DEVELOPMENT CO., 3311 Perkins Ave., Cleveland, Ohio—C: HO: A
 BUD RADIO, INC., 5205 Cedar Ave., Cleveland, Ohio—C: AR, D, E, G, M, S, SS
 J. H. BUNNELL & CO., 215 Fulton St., New York, N. Y.—C: AR, D, E, M
 BURGESS BATTERY CO., P. O. Box 121, Freeport, Ill.—C: D, DIS, E, G, J, M, S
 BUSSMANN MANUFACTURING CO., University at Jefferson, St. Louis, Mo.—C: D, E, M, S
 CAMBRIDGE INSTRUMENT CO., INC., 3732 Grand Central Terminal, New York, N. Y.—C: E, G, M, S, SS
 CAMERON PUBLISHING CO., Coral Gables, Fla.—C: A
 CANADIAN MARCONI CO., 211 St. Sacrament St., Montreal, Can.—C: AR, E, G, S
 CANDLER SYSTEM CO., Box 331, Asheville, N. C.—C: A
 C. F. CANNON CO., Springwater, N. Y.—C: D, S
 CANNON ELECTRIC DEVELOPMENT CO., 3209 Humbolt St., Los Angeles, Calif.—C: HO: E, M, S, SS
 CANTON TRADING CO., 135 Liberty St., New York, N. Y.—C: D
 CARBINE & CARBON CHEMICALS CORP., 30 E. 42nd St., New York, N. Y.—C: HO: E, M
 THE CARBORUNDUM CO., GLOBAR DIV., Niagara Falls, N. Y.—C: E, M
 THE ALLEN D. CARDWELL MFG. CORP., 81 Prospect St., Brooklyn, N. Y.—C: AR, D, E, G, M
 CARRIER MICROPHONE CO., 439 S. La Brea Ave., Inglewood, Calif.—C: AR, D, E, M, S, SS
 CARRON MANUFACTURING CO., 415 S. Aberdeen St., Chicago, Ill.—C: AR, D, E, G, S, SS
 CARTER MOTOR CO., 1608 Milwaukee Ave., Chicago, Ill.—C: A
 CASTLEWOOD MANUFACTURING CO., 12th & Burnett Sts., Louisville, Ky.—C: A
 THE CELOTEX CORPORATION, 919 N. Michigan Ave., Chicago, Ill.—C: HO: A
 CENTRALAB, DIV. OF GLOBE-UNION, INC., 900 E. Keefe Ave., Milwaukee, Wis.—C: A
 CHARGIT CORPORATION, Anderson, Ind.—C: AR, D, E, G, M, S
 CHICAGO MOLDED PRODUCTS CORP., 1020 N. Kolmar Ave., Chicago, Ill.—HO: E
 CHICAGO TECHNICAL COLLEGE, 118 E. 26th St., Chicago, Ill.—C: HO: A
 CHICAGO TELEPHONE SUPPLY CO., 1142 W. Beardsley Ave., Elkhart, Ind.—C: M
 CINCH MANUFACTURING CORP., 2335 W. Van Buren St., Chicago, Ill.—C: D, E, M
 CIRCLE MANUFACTURING CO., 720 Monmouth St., Trenton, N. J.—C: E, M, S, SS
 CLAROSTAT MANUFACTURING CO., INC., 285-287 N. 6th St., Brooklyn, N. Y.—C: A
 THE CLOUGH-BRENGLE CO., 5501 Broadway, Chicago, Ill.—C: AR, D, E, G, M, S, SS
 COLE RADIO WORKS, 86 Westville Ave., Caldwell, N. J.—C: A
 CONDENSER PRODUCTS CO., 1375 N. Branch St., Chicago, Ill.—C: A
 CONSOLIDATED WIRE & ASSOCIATED CORPS., 512 S. Peoria St., Chicago, Ill.—C: HO: M
 CONTINENTAL CARBON, INC., 13900 Lorain Ave., Cleveland, Ohio—C: A
 CONTINENTAL DIAMOND FIBRE CO., Newark, Dela.—C: M
 CONTINENTAL ELECTRIC CO., Geneva, Ill.—HO: D, E, M
 CORNELL-DUBILIER ELECTRIC CORP., South Plainfield, N. J.—C: A
 CORNING GLASS WORKS, Corning, N. Y.—C: AR, D, E, M
 CORNISH WIRE CO., 15 Park Row, New York, N. Y.—C: M
 COYNE ELECTRICAL SCHOOL, 500 S. Paulina St., Chicago, Ill.—C: HO: A
 THE GEORGE F. CRAM CO., 730 E. Washington St., Indianapolis, Ind.—C: A

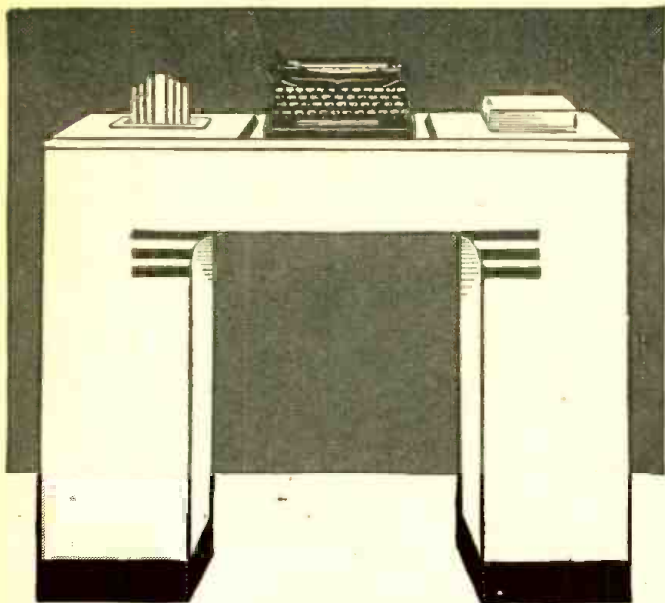

**THIS
BEAUTIFUL DESK
for only \$1.00 EXTRA**

**WITH ANY
REMINGTON
PORTABLE TYPEWRITER**

The
COMBINATION
FOR AS LITTLE AS
10¢ A DAY

How easy it is to pay for this combination of desk and Remington Deluxe Noiseless Portable Typewriter! Just imagine, a small good will deposit with terms as low as 10c a day to get this combination at once! You will never miss 10c a day. Yet this small sum can actually make you immediately the possessor of this amazing office at home combination. You assume no obligations by sending the coupon.

A beautiful desk in a neutral blue-green which will fit into the decorations of any home—trimmed in black and silver—and made of sturdy fibre board—is now available for only one dollar (\$1.00 extra) to purchasers of a Remington Noiseless Portable Typewriter. The desk is so light that it can be moved anywhere without trouble—it is so strong that it will hold six hundred (600) pounds. With this combination of desk and Noiseless Deluxe Portable Typewriter, you will have a miniature office at home. Learn the complete details of this offer. Mail the coupon today.

THESE TWO EXTRA FOR YOU

LEARN TYPING FREE

To help you even further, you get free with this special offer a 32-page booklet, prepared by experts, to teach you quickly how to typewrite by the touch method. When you buy a Noiseless you get this free Remington Rand gift that increases the pleasure of using your Remington Noiseless Deluxe Portable. Remember, the touch typing book is sent free while this offer holds.



SPECIAL CARRYING CASE

The Remington Deluxe Noiseless Portable is light in weight, easily carried about. With this offer Remington supplies a sturdy, beautiful carrying case which rivals in beauty and utility the most attractive luggage you can buy.



SPECIFICATIONS

ALL ESSENTIAL FEATURES of large standard office machines appear in the Noiseless Portable—standard 4-row keyboard; back spacer; margin stops and margin release; double shift key and shift lock; two color ribbon and automatic ribbon reverse; variable line spacer; paper fingers; makes as many as seven carbons; takes paper 9.5" wide; writes lines 8.2" wide. There are also extra features like the card writing attachment, black key cards and white letters, touch regulator, rubber cushioned feet. These make typing on a Remington Deluxe Noiseless Portable a distinct pleasure. Thousands of families now using the Remington Deluxe Noiseless Portable know from experience how wonderful it is!



**MAIL
COUPON
NOW!**

Remington Rand Inc., Dept. 189-10
465 Washington St., Buffalo, N. Y.

Tell me, without obligation, how to get a Free Trial of a new Remington Deluxe Noiseless Portable, including Carrying Case and Free 32-page Typing Instruction Booklet on terms as low as 10c a day. Send Catalogue.

Name.....
Address.....
City..... State.....

• CLASSIFIED RADIO DIRECTORY •

- CRESCENT TOOL & DIE CO., 4140 Belmont Ave., Chicago, Ill.—C: AR, D, G, S, SS
 CROWE NAME PLATE & MFG. CO., 3701 Ravenswood Ave., Chicago, Ill.—C: A
 CRUCIBLE STEEL CO. OF AMERICA, 405 Lexington Ave., New York, N. Y.—C: A
 CRUMPACKER DISTRIB. CORP., 1801 Fannin St., Houston, Tex.—C: AR, D, E, S, SS
 CRYSTAL EAR, INC., 2007 S. Michigan Ave., Chicago, Ill.—C: A
 THE DAVEN COMPANY, 158 Summit St., Newark, N. J.—C: D, E, M, S, SS
 HAROLD DAVIS, INC., 428 W. Capitol St., Jackson, Miss.—C: AR, D, E, G, S, SS
 DAYCO RADIO CORP., 915 Valley St., Dayton, Ohio—C: A
 DAYTON ACME CO., 2339 Gilbert Ave., Cincinnati, Ohio—C: A
 TOBE DEUTSCHMANN CORP., Washington St., Canton, Mass.—C: D, E, M, S, SS
 DeVRY CORPORATION, 1111 Armitage Ave., Chicago, Ill.—HO: A
 DeWALD RADIO MFG. CORP., 440 Lafayette St., New York, N. Y.—C: D, S
 DIAL LIGHT CO. OF AMERICA, INC., 90 West St., New York, N. Y.—C: AR, D, E, G, M, S, SS
 DIRECT OUTLET SALES, 4002 6th Ave., Brooklyn, N. Y.—C: A
 DIRECT TEST INSTRUMENTS CO., 17 W. 60th St., New York, N. Y.—C: A
 DOOLITTLE RADIO, INC., 7421 Loomis Blvd., Chicago, Ill.—C: A
 DRAKE MANUFACTURING CO., 1173 W. Hubbard St., Chicago, Ill.—C: AR, E, G, M, S, SS
 DREMEL MANUFACTURING CO., Racine, Wis.—C: AR, D, E, G, M, S
 DRIVER-HARRIS CO., Harrison, N. J.—C: HO: E, M
 DUAL REMOTE CONTROL CO., INC., 31776 W. Warren Ave., Wayne, Mich.—C: A
 ALLEN B. DU MONT LABS., INC., Passaic, N. J.—C: HO: M
 DUPLEX RECORDING DEVICES CO., 1041 Manor Ave., New York, N. Y.—C: A
 E. I. DU PONT DE NEMOURS & CO., 626 Schuyler Ave., Arlington, N. J.—HO: E, G, M, S, SS
 EAGLE ELECTRIC MFG. CO., INC., 57-59 Hall St., Brooklyn, N. Y.—C: D, DIS, M
 EASTERN MIKE-STAND CO., 56 Christopher Ave., Brooklyn, N. Y.—C: A
 HUGH H. EBY, 4700 Stenton Ave., Phila., Pa.—C: E, M
 E. A. ECKSTEIN COMPANY, LeRoy, Minn.—C: D, E, S, SS
 EICOR, INC., 515 S. Laffin St., Chicago, Ill.—C: D, E, M
 EISLER ENGINEERING CO., 750 S. 13th St., Newark, N. J.—C: D, E, M
 THE ELECTRIC AUTO-LITE CO., WIRE DIV., Port Huron, Mich.—C: D, E, M
 ELECTRIC SOLDERING IRON CO., INC., W. Elm St., Deep River, Conn.—C: AR, D, E, G, M, S, SS
 ELECTRONIC APPLICATIONS, Brunswick, Me.—HO: A
 ELECTRONIC LABORATORIES, INC., 122 W. New York St., Indianapolis, Ind.—C: AR, E, M
 ELECTRONIC PRODUCTS CO., St. Charles, Ill.—C: D, E, M, S
 ELECTRO PRODUCTS LABS., 549 W. Randolph St., Chicago, Ill.—C: AR, D, E, G, M, S, SS
 ELECTRO-VOICE MFG. CO., INC., 1239 S. Bend Ave., South Bend, Ind.—C: A
 GEORGE D. ELLIS & SONS, INC., 309 N. 3rd St., Phila., Pa.—C: M
 ENGINEERING RESEARCH CORP., 909 Giddens-Lane Bldg., Shreveport, La.—C: A
 EPIPHONE, INC., 142 W. 14th St., New York, N. Y.—C: A
 ERIE RESISTOR CORP., 644 W. 12th St., Erie, Pa.—C: E, M, S, SS
 ERWOOD SOUND EQUIPMENT CO., 224 W. Huron St., Chicago, Ill.—C: A
 ESPY MANUFACTURING CO., INC., 305 E. 63rd St., New York, N. Y.—C: D, S
 THE ESTERLINE-ANGUS CO., INC., Box 596, Indianapolis, Ind.—C: HO: E, M, S, SS
 EVERETT PIANO CO., South Haven, Mich.—C: HO: A
 EXECUTONE, INC., 415 Lexington Ave., New York, N. Y.—C: HO: D, E, G, M, S, SS
 "FADE-O-METER CO.," 1027 S. W. Broadway, Portland, Ore.—C: D, M, S
 FAHNESTOCK ELECTRIC CO., 46-44 11th St., Long Island City, N. Y.—C: A
 FAIRCHILD AVIATION CORP., SOUND EQUIPMENT DIV., 88-06 Van Wyck Blvd., Jamaica, L. I., N. Y.—C: E, S, S
 FARNSWORTH TELEVISION & RADIO CORP., 3702 E. Pontiac St., Fort Wayne, Ind.—C: D, E, G, M, S
 JOHN E. FAST & CO., 3123 N. Pulaski Ave., Chicago, Ill.—C: E, M
 FEDERAL RECORDER CO., INC., 630 S. Wabash Ave., Chicago, Ill.—C: D, E, S, S
 FEDERAL SCREW PRODUCTS CO., 24-26 S. Jefferson St., Chicago, Ill.—C: E, M, S, S
 FEDERAL TELEGRAPH CO., 200 Mt. Pleasant Ave., Newark, N. J.—C: A
 FEDERATED PURCHASER, INC., 80 Park Pl., New York, N. Y.—C: A
 FERRIS INSTRUMENT CORP., Boonton, N. J.—C: D, E, M
 FINCH TELECOMMUNICATIONS, INC., 1819 Broadway, New York, N. Y.—C: E, M
 FISCHER DISTRIB. CORP., 222 Fulton St., New York, N. Y.—C: A
 FISHER RESEARCH LABS., Palo Alto, Calif.—C: A
 A. B. FISHWICK RADIO CO., 139 W. 4th St., Cincinnati, Ohio—C: E, M
 M. M. FLERON & SON, INC., 113 N. Broad St., Trenton, N. J.—C: D, S
 THE FORMICA INSULATION CO., 4614 Spring Grove Ave., Cincinnati, Ohio—C: E, M
 THE FORSBERG MFG. CO., 125 Seaview Ave., Bridgeport, Conn.—C: D, E, M
 FREED RADIO CORP., 39 W. 19th St., New York, N. Y.—C: D
 GARDINER METAL CO., 4820 S. Campbell Ave., Chicago, Ill.—C: E, M
 GAROD RADIO CORP., 70 Washington St., Brooklyn, N. Y.—C: D, M
 GARRARD SALES CORP., 296 Broadway, New York, N. Y.—C: A
 GEM EAR PHONE CO., INC., 47 W. 34th St., New York, N. Y.—C: A
 GENERAL CEMENT MFG. CO., 919 Taylor Ave., Rockford, Ill.—C: A
 GENERAL CERAMICS CO., Plant No. 3, Keasbey, N. J.—C: E, M
 GENERAL COMMUNICATIONS PRODUCTS CO., 6245 Lexington Ave., Hollywood, Calif.—C: D, E, S, S
 GENERAL DRY BATTERIES, INC., 13000 Athens Ave., Cleveland, Ohio—C: D, E, M, S
 GENERAL ELECTRIC CO., Schenectady, N. Y. & Bridgeport, Conn.—C: A
 GENERAL INSULATED WIRE CO., 53 Park Pl., New York, N. Y.—C: J, M
 GENERAL RADIO CO., 30 State St., Cambridge, Mass.—C: HO: E, M
 GENERAL TRANSFORMER CORP., 1250 W. Van Buren St., Chicago, Ill.—C: A
 M. A. GERETT CORP., 2947 N. 30th St., Milwaukee, Wis.—C: A
 GIRARD-HOPKINS, 1000 40th Ave., Oakland, Calif.—C: D, E, M
 GLOBE PHONE MFG. CORP., Reading, Mass.—C: AR, D, E, G, M, S, SS
 GOAT RADIO TUBE PARTS, INC., 314 Dean St., Brooklyn, N. Y.—C: E, M
 THE GOLDAK COMPANY, 1031 S. Broadway, Los Angeles, Calif.—C: A
 GOLDENTONE RADIO CO., 15123 Warren Ave., Dearborn, Mich.—C: AR, D, G, S
 INTERCAL SYSTEMS, INC., 5th & Norwood, Dayton, Ohio—C: D
 INTERNATIONAL RESISTANCE CO., 401 N. Broad St., Phila., Pa.—C: A
 CHARLES JACK MFG. CORP., 27 E. Philadelphia St., York, Pa.—C: A
 THE JACKSON ELECTRICAL INSTRUMENT CO., 129 Wayne Ave., Dayton, Ohio—C: AR, D, E, G, M, S, SS
 JAMES WIRE & CABLE CO., 1014 Madison Ave., Toledo, Ohio—C: E, M
 JADUR IMPORT CO., 21 W. 19th St., New York, N. Y.—C: AR, D, E, G, M, S, SS
 JANETTE MANUFACTURING CO., 556 W. Monroe St., Chicago, Ill.—C: A
 JEFFERSON ELECTRIC CO., Bellwood, Ill.—C: A
 RAY JEFFERSON, INC., 182 Milburn Ave., Baldwin, N. Y.—C: D, S, MS
 JENSEN RADIO MFG. CO., 6601 S. Laramie Ave., Chicago, Ill.—C: A
 J. F. D. MANUFACTURING CO., 4111 Ft. Hamilton Pkwy., Brooklyn, N. Y.—C: A
 E. F. JOHNSON COMPANY, Waseca, Minn.—C: A
 HOWARD B. JONES, 2300 Wabansia Ave., Chicago, Ill.—C: E, M, S, S
 KAAR ENGINEERING CO., 619 Emerson St., Palo Alto, Calif.—C: A
 B. F. GOODRICH COMPANY, 500 S. Main St., Akron, Ohio—C: E, M
 GORDON SPECIALTIES CO., 1104 S. Wabash Ave., Chicago, Ill.—C: AR, D, E, M
 CARL GORR PRINTING CO., 2615 N. Ashland Ave., Chicago, Ill.—C, HO, E, M
 L. F. GRAMMES & SONS, INC., 361 Union St., Allentown, Pa.—C: HO: E, M
 GRAY RADIO CO., 730 Okeechobee Rd., W. Palm Beach, Fla.—C: A
 GUARDIAN ELECTRIC MFG. CO., 1621-27 W. Walnut St., Chicago, Ill.—C: AR, D, E, G, M
 EDWIN I. GUTHMAN & CO., INC., 400 S. Peoria St., Chicago, Ill.—C: D, E, M
 ROBERT M. HADLEY CO., 709-11 E. 61st St., Los Angeles, Calif.—C: A
 THE HALLDORSON CO., 4500 Ravenswood Ave., Chicago, Ill.—C, HO: D, S
 HALLICRAFTERS, 2611 Indiana Ave., Chicago, Ill.—C: A
 HAMMARLUND MFG. CO., INC., 424 W. 33rd St., New York, N. Y.—C: A
 HAMMOND INSTRUMENT CO., 2915 N. Western Ave., Chicago, Ill.—C, HO: A
 HAMMOND MANUFACTURING CO., Guelph, Ontario, Can.—C: A
 HARDWICK, HINDLE, INC., 40 Hermon St., Newark, N. J.—C: A
 D. H. HARRELL, 1527 E. 74th Pl., Chicago, Ill.—C: A
 HARRIS MANUFACTURING CO., 2422 W. 7th St., Los Angeles, Calif.—HO: D, S, S, S
 HARRISON RADIO CO., 12 W. Broadway, New York, N. Y.—C: AR, D, E, M
 HARTMAN ELECTRICAL MFG. CO., Mansfield, Ohio—C: A
 HARVEY-WELLS COMMUNICATIONS, INC., Box 100, Southbridge, Mass.—C: A
 H-B INSTRUMENT CO., INC., 2518 N. Broad St., Phila., Pa.—C: D, E, G, M, S, S, S
 HEINEMANN CIRCUIT BREAKER CO., Penna. Ave. & Plum St., Trenton, N. J.—C: A
 HEINTZ & KAUFMAN, LTD., South San Francisco, Calif.—C: AR, E, M
 W. C. HELLER & CO., Montpelier, Ohio—C: D, E, G, M, S, S, S
 HETRO ELECTRICAL INDUSTRIES, INC., 5819 N. Drake Ave., Chicago, Ill.—C: D, S
 HEWLETT-PACKARD CO., 481 Page Mill Rd., Palo Alto, Calif.—C: A
 THE HICKOK ELECTRICAL INSTRUMENT CO., 10514 Dupont Ave., Cleveland, Ohio—C: A
 HIPOWER CRYSTAL CO., 205 W. Wacker Drive, Chicago, Ill.—C: AR, D, E, G, M
 HOLLYWOOD TRANSFORMER CO., 5334 Hollywood Blvd., Hollywood, Calif.—C: AR, E, G, M, S, S
 HERBERT H. HORN, 1201 S. Olive St., Los Angeles, Calif.—C: D
 HOWARD RADIO CO., 1735 Belmont Ave., Chicago, Ill.—C: A
 HYGRADE SYLVANIA CORP., 500 5th Ave., New York, N. Y.—C (35c), HO: A
 HYTRON CORPORATION, 76 Lafayette St., Salem, Mass.—C: E, M
 HYTRONIC LABORATORIES, 76 Lafayette St., Salem, Mass.—C: AR, E, G, M
 IDEAL COMMUTATOR DRESSER CO., Sycamore, Ill.—C: D, E, M, S
 ILLINOIS CONDENSER CO., 1160 N. Howe St., Chicago, Ill.—C: A
 IMPERIAL MOLDED PRODUCTS CORP., 2925 W. Harrison St., Chicago, Ill.—C: A
 INDEPENDENT PNEUMATIC TOOL CO., 600 W. Jackson Blvd., Chicago, Ill.—C: D, E, M, S, S, S
 INDUSTRIAL CONDENSER CORP., 4049 Diversey Ave., Chicago, Ill.—C: A
 INSTRUMENT RESISTORS, INC., 25 Amity St., Little Falls, N. J.—C: E, M
 INSULATION MANUFACTURERS CORP., 565 W. Washington Blvd., Chicago, Ill.—C, D, E, G, M, S, S, S
 INSULINE CORP. OF AMERICA, 3030 Northern Blvd., Long Island City, N. Y.—C: A
 KATO ENGINEERING CO., INC., 530 N. Front St., Mankato, Minn.—C: A
 KAY MUSICAL INSTRUMENT CO., 1640 Walnut St., Chicago, Ill.—C: D, DIS
 KELLOGG SWITCHBOARD & SUPPLY CO., 6650 S. Cicero Ave., Chicago, Ill.—C, HO: E, M
 KENYON TRANSFORMER CO., INC., 840 Barry St., Bronx, N. Y.—C: A
 WALTER KIDDE & CO., 62 West St., Bloomfield, N. J.—C: HO: E, M
 KING LABORATORIES, INC., 205 Oneida St., Syracuse, N. Y.—C: M
 THE H. R. KIRKLAND CO., INC., 10 King St., Morristown, N. J.—C: A
 KRAEUTER & CO., INC., 585 18th Ave., Newark, N. J.—C: D, E, M, S
 KURZ-KASCH, INC., 1421 S. Broadway, Dayton, Ohio—C: E, M
 LAFAYETTE RADIO CORP., 100 6th Ave., New York, N. Y.—C: A
 LAKE MANUFACTURING CO., INC., 2323 Chestnut St., Oakland, Calif.—C: A
 LAMPKIN LABORATORIES, Bradenton, Fla.—C: A
 LAUREHK RADIO MFG. CO., 3918 Monroe Ave., Wayne, Mich.—C: D, E, M
 THE LAUSON COMPANY, New Holstein, Wis.—C: D, E, M, S
 LEACH RELAY CO., 5915 Avalon Blvd., Los Angeles, Calif.—C: A
 LEAR AVIA, INC., Dayton, Ohio, and 30 Rockefeller Plaza, New York, N. Y.—C: D, E, M, P
 LECTROHM, INC., 5133 W. 25th Pl., Cicero, Ill.—C, A
 LAFEBURE CORPORATION, 716 Oakland Rd., Cedar Rapids, Ia.—C: A
 LEJAY MANUFACTURING CO., 1406 W. Lake St., Minneapolis, Minn.—C: A
 LEKTRA LABORATORIES, INC., 30 E. 10th St., New York, N. Y.—C: A
 LEOTONE RADIO CO., 63 Dey St., New York, N. Y.—C: A
 LETERSTONE SALES CO., 2515 S. Wabash Ave., Chicago, Ill.—C: D, S
 THE LIFETIME CORP., 1825 Adams St., Toledo, Ohio—C: A
 THE LINCROPHONE CO., INC., 1661 Howard Ave., Utica, N. Y.—C: S
 JOHN E. LINGE & SON, INC., 28th St., & Buren Ave., Camden, N. J.—C: E
 LITTELFUSE, INC., 4757 Ravenswood Ave., Chicago, Ill.—C, A
 LOWELL INSULATED WIRE CO., 171 Lincoln St., Lowell, Mass.—C: D
 LOWELL NEEDLE CO., INC., Putnam, Conn.—C: D
 LUMENITE ELECTRIC CO., 407 S. Dearborn St., Chicago, Ill.—C: A
 T. R. McLEROY, 100 Brookline Ave., Boston, Mass.—C: A
 M. & H. SPORTING GOODS CO., 512 Market St., Phila., Pa.—C: HO: AR, D, E, G, M, S, S, S
 MAICO COMPANY, INC., 83 S. 9th St., Minneapolis, Minn.—C: A
 MAJESTIC RADIO & TELEVISION CORP., 2600 W. 50th St., Chicago, Ill.—C: A
 P. R. MALLORY & CO., INC., 3029 E. Washington St., Indianapolis, Ind.—C: A
 MANUFACTURING SCREW PRODUCTS, 214 W. Hubbard St., Chicago, Ill.—C: D, E, M, S, S, S
 MARINE RADIO CORP., 117-19 168th St., Jamaica, N. Y.—C: A
 MEASUREMENTS CORP., 212 Harrison St., Boonton, N. J.—C: E, M
 JOHN MECK INDUSTRIES, 1313 W. Randolph St., Chicago, Ill.—C, HO: D, S, S, S
 MEISSNER MANUFACTURING CO., Mt. Carmel, Ill.—C: A

• CLASSIFIED RADIO DIRECTORY •

- MELLOPHONE CORPORATION, 65 Atlantic Ave., Rochester, N. Y.—C: D, E, M, SS
- MICA INSULATOR CO., 200 Varick St., New York, N. Y.—C: A
- MICAMOLD RADIO CORP., 1087 Flushing Ave., Brooklyn, N. Y.—C: AR, D, G, S, SS
- CHARLES MICHELSON ELECTRICAL TRANSCRIPTIONS, 67 W. 44th St., New York, N. Y.—C: A
- MIDLAND RADIO & TELEVISION SCHOOLS, INC., Power & Light Bldg., Kansas City, Mo.—C, HO: A**
- MIDWEST RADIO CORP., 909 Broadway, Cincinnati, Ohio—C: A
- MILES REPRODUCER CO., INC., 812 Broadway, New York, N. Y.—C: A
- JAMES MILLEN MFG. CO., INC., 150 Exchange St., Malden, Mass.—C: A
- J. W. MILLER COMPANY, 5917 S. Main St., Los Angeles, Calif.—C: A
- MILLION RADIO & TELEVISION, 1617 N. Damen Ave., Chicago, Ill.—C: A
- ELMER E. MILLS CORP., 812 W. Van Buren St., Chicago, Ill.—C: M
- MIMS RADIO CO., P.O. Box 504, Texarkana, Ark.—C: AR, D, E, M
- MIRROR RECORD CORP., 58 W. 25th St., New York, N. Y.—C: D, E, M, SS
- MISENER MANUFACTURING CO., 1747 58th St., Brooklyn, N. Y.—C: A
- MISSION BELL RADIO MFG. CO., INC., 831-833 Venice Blvd., Los Angeles, Calif.—C: D, S
- MONTGOMERY WARD & CO., INC., 619 W. Chicago Ave., Chicago, Ill.—C: A
- MUELLER ELECTRIC CO., 1583 E. 31st, Cleveland, Ohio—C: A
- MUSIC MASTER MFG. CO., 508 S. Dearborn St., Chicago, Ill.—C: D
- MUSICRAFT RECORDS, INC., 10 W. 47th St., New York, N. Y.—C: A
- NASH RADIO PRODUCTS CO., 6267 Gravois Ave., St. Louis, Mo.—C: A
- NATIONAL CARBON CO., INC., 30 E. 42nd St., New York, N. Y.—C: D
- NATIONAL COMPANY, INC., 61 Sherman St., Malden, Mass.—C: A
- NATIONAL DOBRO CORP., 400 S. Peoria St., Chicago, Ill.—C: A
- NATIONAL UNION RADIO CORP., 57 State St., Newark, N. J.—C, HO: A**
- NATIONAL VULCANIZED FIBRE CO., P.O. Box 311, Wilmington, Del.—C: E, M
- NEW ART SPECIALTIES, INC., 816 W. Erie St., Chicago, Ill.—C: E, M
- NOBLITT-SPARKS INDUSTRIES, INC., Columbus, Ind.—C: D, DIS, J
- OAK MANUFACTURING CO., 1260 Clybourn Ave., Chicago, Ill.—C: E, M
- THE OHIO CARBON CO., 12508 Berea Rd., Cleveland, Ohio—C: A
- OHIO CRANKSHAFT CO., Tocco Div., 660 Clement Ave., Cleveland, Ohio—C: E, M
- OHMITE MANUFACTURING CO., 4835 W. Flournoy St., Chicago, Ill.—C, HO: AR, D, E, G, M, S, SS
- A. OLEK, 4759 Melrose St., Phila., Pa.—C: AR, M, S, SS
- OLSON MANUFACTURING CO., 362 Wooster Ave., Akron, Ohio—C: A
- OPERADIO MANUFACTURING CO., St. Charles, Ill.—C: A
- OXFORD-TARTAK RADIO CORP., 915 W. Van Buren St., Chicago, Ill.—C: AR, G, S, SS
- PARAPHONE HEARING AID, INC., 4300 Euclid Ave., Cleveland, Ohio—C: D, S
- PARISIAN NOVELTY CO., 3510 S. Western Ave., Chicago, Ill.—C: M
- PARKER-KALON CORP., 200 Varick St., New York, N. Y.—C: A
- PAR-METAL PRODUCTS CORP., 32-62 49th St., Long Island City, N. Y.—C: AR, D, E, G, M, S, SS
- PAUL & BEEKMAN, 4250 Wissahickon Ave., Phila., Pa.—C: M
- HENRY PAWKEN & CO., 37 S. Wabash Ave., Chicago, Ill.—C, HO: D
- PEERLESS ALBUM CO., INC., 38 W. 21st St., New York, N. Y.—C: D, M, S
- PERMO PRODUCTS CORP., 6415 Ravenswood Ave., Chicago, Ill.—C: A
- PETERSEN RADIO CO., 205 N. 17th St., Council Bluffs, Iowa—C: A**
- PHILHARMONIC RADIO CO., 21 W. 45th St., New York, N. Y.—C: A
- PHILMORE MANUFACTURING CO., 113 University Pl., New York, N. Y.—C: AR, D, E, G, M, S, SS
- PHONOTONE LABORATORIES, INC., S.E. 15th St., Washington, Ind.—C, HO: A
- PHOTOBELL CORPORATION, 123 Liberty St., New York, N. Y.—C: AR, D, E, G, M, S
- PILOT RADIO CORP., 37-06 36th St., Long Island City, N. Y.—C: A
- PIONEER GEN-E-MOTOR CORP., 466 W. Superior St., Chicago, Ill.—C: A
- PIONEER SPECIALTY CO., 5100 St. Jean Ave., Detroit, Mich.—C: D, S
- PITTMAN ELECTRICAL DEVELOPMENTS CO., 127 Nippon St., Phila., Pa.—C: AR, D, E, G, M
- POINSETTIA, INC., Pitman, N. J.—C: M
- PORCELAIN PRODUCTS, INC., P.O. Box 300, Findlay, Ohio—C: D, E, M
- PRECISION APPARATUS CO., 647 Kent Ave., Brooklyn, N. Y.—C: A
- PRECISION CRYSTAL LABS., Springfield Airport, Springfield, Mass.—C: AR, D, E, G, M
- PRECISION PIEZO SERVICE, 427 Asia St., Baton Rouge, La.—C: A
- PREMAX PRODUCTS DIV., CHISHOLM-RYDER CO., INC., Drawer F, Bridge Sta., Niagara Falls, N. Y.—C: AR, D, E, G, M, S, SS
- PREMIER CRYSTAL LABS., INC., 53 Park Row, New York, N. Y.—C: A
- PRESTO RECORDING CORP., 242 W. 55th St., New York, N. Y.—C: D, E, M, S, SS
- QUAM-NICHOLS COMPANY, 33rd Pl. & Cottage Grove Ave., Chicago, Ill.—C: A
- RACON ELECTRIC CO., INC., 52 E. 19th St., New York, N. Y.—C: A
- RADEX CORPORATION, 1733 Milwaukee Ave., Chicago, Ill.—C: A
- RADIO CITY PRODUCTS CO., INC., 88 Park Pl., New York, N. Y.—C: A
- RADIO COLLEGE OF CANADA, 54 Bloor St. W., Toronto, Ont., Can.—C: D, E, M, S, SS
- RADIO DESIGN CO., 1353 Sterling Pl., Brooklyn, N. Y.—C: A
- RADIO ELECTRIC SERVICE CO., INC., N. W. Cor. 7th & Arch Sts., Phila., Pa.—C: AR, D, E, G, M, S, SS**
- RADIO ENGINEERING LABS., INC., 35-54 36th St., Long Island City, N. Y.—C: A
- RADIO MFG. ENGINEERING, INC., 111 Harrison St., Peoria, Ill.—C: A
- RADIO NAVIGATIONAL INSTRUMENT CORP., 500 5th Ave., New York, N. Y.—C: A
- RADIO & TECHNICAL PUBLISHING CO., 45 Astor Pl., New York, N. Y.—C: A**
- THE RADIOTECHNIC LABORATORY, 1328 Sherman Ave., Evanston, Ill.—C: A
- RADIOTONE, INC., 7356 Melrose Ave., Hollywood, Calif.—C: A**
- RADIO TRANSCEIVER LABS., 8627 115th St., Richmond Hill, N. Y.—C: A
- RADOLEK COMPANY, 601 W. Randolph St., Chicago, Ill.—C: A
- RAWSON ELECTRICAL INSTRUMENT CO., 110 Potter St., Cambridge, Mass.—C: D, E, G, M, SS
- RAY-LAB COMPANY, Grand Central & 11th St., Elmira Heights, N. Y.—C: AR, D, E, G, M, S, SS
- RAY-O-VAC COMPANY, 2317 Winnebago St., Madison, Wis.—C: J, M
- R-B-M MANUFACTURING CO., Div. Essex Wire Corp., Hanna & Chestnut St., Logansport, Ind.—C: E, M
- R.C.A. INSTITUTES, INC., 75 Varick St., New York, N. Y.—C: A
- RCA MANUFACTURING CO., INC., Camden, N. J.—C: A
- READRITE METER WORKS, Bluffton, Ohio—C: AR, D, E, G, M, S, SS
- RECOTON CORPORATION, 178 Prince St., New York, N. Y.—C: A
- REGAL AMPLIFIER MFG. CORP., 14 W. 17th St., New York, N. Y.—C: D, E, M, S, SS
- REK-O-KUT CORPORATION, 173 Lafayette St., New York, N. Y.—C: AR, E, G, S, SS
- REMLER COMPANY LTD., 2101 Bryant St., San Francisco, Calif.—C: D, E
- REX RHEOSTAT CO., 37 W. 20th St., New York, N. Y.—C: A
- M. H. RHODES, INC., 30 Bartholomew Ave., Hartford, Conn.—C: A
- JOHN F. RIDER PUBLISHER, INC., 404 4th Ave., New York, N. Y.—C, HO: A**
- THE RIVERSIDE METAL CO., Pavilion Ave., Riverside, N. J.—C: E, M
- ROGERS-MAJESTIC CORP. LTD., 622 Fleet St., Toronto, Can.—C: AR, D, S
- THE ROLA COMPANY, INC., 2530 Superior Ave., Cleveland, Ohio—C: D, E, M, S, SS
- ALBERT F. ROSS & CO., 2341 Wolfram St., Chicago, Ill.—C: D, M, S
- ROWE INDUSTRIES, INC., 3120 Monroe St., Toledo, Ohio—C: D, E, S, SS
- THE RUBY CHEMICAL CO., 68-70 McDowell St., Columbus, Ohio—C: A
- SAUERREISEN CEMENTS CO., 2308 Main St., Sharpsburg, Pittsburgh, Pa.—C: A
- WALTER L. SCHOTT CO., 5264 1/2 W. Pico Blvd., Los Angeles, Calif.—C: AR, D, E, G, M, S, SS**
- MAURICE SCHWARTZ & SON, 710-712 Broadway, Schenectady, N. Y.—C: AR, G, S, SS
- E. H. SCOTT RADIO LABS., INC., 4450 Ravenswood Ave., Chicago, Ill.—C, HO: A
- SCOVILL MANUFACTURING CO., 99 Mill St., Waterbury, Conn.—C: E, M
- SEATTLE RADIO SUPPLY CO., INC., 2117 2nd Ave., Seattle, Wash.—C: A
- SELECTAR MANUFACTURING CORP., 30 W. 15th St., New York, N. Y.—C: A
- SELF-VULCANIZING RUBBER CO., INC., 605 W. Washington Blvd., Chicago, Ill.—C: A
- SENTINEL RADIO CORP., 2020 Ridge Ave., Evanston, Ill.—C: DIS
- SHAKEPROOF LOCK WASHER CO., 2501 N. Keeler Ave., Chicago, Ill.—C: E, M
- SHALLCROSS MANUFACTURING CO., 10 Jackson Ave., Collingdale, Pa.—C: A
- H. B. SHERMAN MFG. CO., 22 Barney St., Battle Creek, Mich.—C: D, E, M, S
- SHURE BROTHERS, 225 W. Huron St., Chicago, Ill.—C: A
- SIERRA AIRCRAFT, P.O. Box A, Sierra Madre, Calif.—C: A
- SIMPSON ELECTRIC CO., 5216-18 W. Kinzie St., Chicago, Ill.—C: AR, D, E, M, S, SS
- MARK SIMPSON DISTRIB. CO., INC., 16 Hudson St., New York, N. Y.—C: J
- A. L. SMITH IRON CO., 217 Everett Ave., Chelsea, Mass.—C: D, E, M
- SNYDER, INC., Noble & Darien St., Phila., Pa.—C: D, S
- SOLA ELECTRIC CO., 2525 Clybourn Ave., Chicago, Ill.—C: AR, D, E, G, M, SS
- SOLAR MANUFACTURING CORP., 25th St. & Ave. "A", Bayonne, N. J.—C: A
- S.O.S. CINEMA SUPPLY CORP., 636 11th Ave., New York, N. Y.—C: D, E, M, S, SS
- SOUND APPARATUS CO., 150 W. 46th St., New York, N. Y.—C, HO: D, E, M, S, SS
- SOUTH BEND LATHE WORKS, 425 E. Madison St., South Bend, Ind.—C: A
- SPEAK-O-PHONE RECORDING & EQUIPMENT CO., 23 W. 60th St., New York, N. Y.—C: A
- SPEEDWAY MANUFACTURING CO., 1834 S. 52nd Ave., Cicero, Ill.—C: A
- SPENCER THERMOSTAT CO., 34 Forest St., Attleboro, Mass.—C: M
- SPRAGUE PRODUCTS CO., North Adams, Mass.—C: A
- STACKPOLE CARBON CO., Tannery St., St. Marys, Pa.—C: E
- STANDARD ELECTRICAL PRODUCTS CO., 317 Sibley St., St. Paul, Minn.—C: A
- STANDARD PIEZO CO., Cedar & Louthers Sts., Carlisle, Pa.—C: E, M
- STANDARD TRANSFORMER CORP., 1500 N. Halsted St., Chicago, Ill.—C: A
- STANLEY TOOLS, New Britain, Conn.—C: AR, D, E, M, S
- STARK ELECTRICAL INSTRUMENT CO., 161A King St. W., Toronto, Ont., Can.—C, HO: D, E, M, S
- THE STATES COMPANY, 19 New Park Ave., Hartford, Conn.—C: D, E, G, M, S
- THE STERLING MANUFACTURING CO., 9205 Detroit Ave., Cleveland, Ohio—C: AR, D, M, S
- STEVENS WALDEN, INC., 475 Shrewsbury St., Worcester, Mass.—C: A
- F. W. STEWART MFG. CORP., 340 W. Huron St., Chicago, Ill.—C: E, M, S
- STRUTHERS DUNN, INC., 1315 Cherry St., Phila., Pa.—C: AR, D, E, G, M, S, SS
- STUPAKOFF LABORATORIES, INC., 6627 Hamilton Ave., Pittsburgh, Pa.—C: M
- SUNDT ENGINEERING CO., 4656 Ravenswood Ave., Chicago, Ill.—C: A**
- SUN RADIO CO., 212 Fulton St., New York, N. Y.—C: A
- SUPERIOR INSTRUMENT CO., 136 Liberty St., New York, N. Y.—C: A
- SUPREME INSTRUMENT CORP., Howard St., Greenwood, Miss.—C: A
- SUPREME PUBLICATIONS, 3727 W. 13th St., Chicago, Ill.—C, HO: A
- TALK-A-PHONE MFG. CO., 1219 W. Van Buren St., Chicago, Ill.—C: D, J, S, SS
- TAY BERN EQUIPMENT CORP., 135 Liberty St., New York, N. Y.—C: A (special literature available to Police & Gov't Depts.)
- TAYLOR AIRPHONE PRODUCTS, INC., Long Beach Municipal Airport, Long Beach, Calif.—C: A
- TAYLOR TUBES, INC., 2341 Wabansia Ave., Chicago, Ill.—C: AR, E, M (5c from company direct)
- TELEVISO PRODUCTS, INC., 135 N. Cicero Ave., Chicago, Ill.—C: D, E, G, M, S, SS**
- TELEX PRODUCTS CO., Minneapolis, Minn.—C: E, M
- TELFAIR TELFONE CORP., 62 Standish Ave., West Orange, N. J.—C: D, E, G, M, S, SS
- THE WM. A. THOMAS CO., 321 Caroline St., Neenah, Wis.—C: AR, G, S
- THORDARSON ELECTRIC MFG. CO., 500 W. Huron St., Chicago, Ill.—C: A
- TILTON ELECTRIC CORP., 15 E. 26th St., New York, N. Y.—C: A
- TONK MANUFACTURING CO., 1912 N. Magnolia Ave., Chicago, Ill.—C: D
- THE TORK CLOCK CO., INC., 1 Grove St., Mt. Vernon, N. Y.—C: A
- TRANSFORMER CORP. OF AMERICA, 69 Wooster St., New York, N. Y.—C: D, E, M, S, SS
- TRANSMARINE RADIO, INC., 1184 Broadway, Hewlett, L. I., N. Y.—C: D, E, S
- TRAVLER RADIO & TELEVISION CORP., 1036 Van Buren, Chicago, Ill.—C: D
- TRICO FUSE MFG. CO., 2948 N. 5th St., Milwaukee, Wis.—C: D, E, M, S
- TRIMM MANUFACTURING CO., LTD., 1770 W. Berteau, Chicago, Ill.—C: A
- THE TRIPLET ELECTRICAL INSTRUMENT CO., 286 Harmon Rd., Bluffton, Ohio—C, HO: A
- TROY RADIO & TELEVISION CO., 1144 S. Olive St., Los Angeles, Calif.—C: D
- TRY-MO RADIO CO., INC., 85 Cortlandt St., New York, N. Y.—C: D, G, S
- TUNG-SOL LAMP WORKS, INC., Radio Tube Div., 95 8th Ave., Newark, N. J.—DB: D, E, M, S (\$1.50)
- THE TURNER COMPANY, 909 17th Ave., Cedar Rapids, Iowa—C: A
- THE ULTIMATE TRANSMITTER CO., 4163 Budlong Ave., Los Angeles, Calif.—C: A
- UNION STEEL CHEST CORP., 54 Church St., LeRoy, N. Y.—C: D, M
- UNITED CINEPHONE CORP., Torrington, Conn.—C: A
- UNITED ELECTRONICS CO., 42 Spring St., Newark, N. J.—C: E, M
- UNITED SCIENTIFIC LAB., INC., 440 Lafayette St., New York, N. Y.—C: D, S
- UNITED STATES TELEVISION MFG. CORP., 220 E. 51st St., New York, N. Y.—C: D
- UNITED TELEPHONE CORP., 150 Varick St., New York, N. Y.—C: A
- UNITED TRANSFORMER CORP., 150 Varick St., New York, N. Y.—C: AR, D, E, G, M, S, SS
- UNIVERSAL MICROPHONE CO., LTD., 424 Warren Lane, Inglewood, Calif.—C: A

SUPER SPECIALS

All of the attractive items listed here are brand new. ALL are in PERFECT WORKING ORDER. In many cases, the parts alone total more than the price we are asking. 100% satisfaction guaranteed or your money refunded. ORDER FROM THIS PAGE. Use the convenient coupon below. Include sufficient extra remittance for parcel post charges, also order shipping express, collect. Any excess will be refunded. C.O.D. shipments require 20% deposit. If full remittance accompanies order, deduct 2% discount. Send money order, certified check, new U. S. stamps. No C.O.D. to foreign countries.

ORDER TODAY LIMITED QUANTITIES PROMPT SHIPMENTS ASSURED

THE RADIUM SPINTHARISCOPE

WORLDS DESTROYED BEFORE YOUR EYES



THE SPINTHARISCOPE is without question one of the most amazing scientific instruments ever invented. For ages scientists thought that atoms were indestructible. Yet the SPINTHARISCOPE demonstrates that radium actually destroys atoms. Look into the SPINTHARISCOPE and behold a most astonishing sight. You see a whole firmament lit up like a brilliant night sky. You observe thousands of "stars" and untold bright flashes similar to showers of shooting stars. Every flash is the result of the destruction of one atom of radium. As each radium atom disintegrates, it creates a Helium atom which it shoots out like a bullet at the terrific speed of 10,000 miles a second. These fast moving Helium atoms (also called Alpha rays) produce a minute flash of light when they strike a crystal of zinc sulphide contained in the SPINTHARISCOPE. The magnifying lens of the instrument makes these flashes visible to your eye and you actually see the perpetual movement of the tiniest particles of matter known to science. The action keeps on going, not only for a few minutes, or days, but actually for over 1,800 years, never stopping. Thus, the Radium in the SPINTHARISCOPE, if preserved, will outlive you and many succeeding generations.

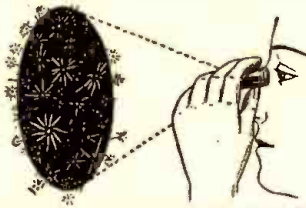

Our SPINTHARISCOPE actually contains a small quantity of radium. If you want to see a most awe-inspiring sight, witness the actual destruction of thousands of worlds (atoms are miniature worlds), by simply looking through the lens of the instrument.

See RADIUM DESTROYED BEFORE YOUR EYES.

THE RADIUM SPINTHARISCOPE. Price, Postpaid... 50c

VARIABLE SPEED UNIVERSAL MOTOR

FOR 110 VOLTS. A.C. OR D.C.

Made for Dictaphone machines by American Gramophone Co. Used, but in excellent condition. Special lever control permits variable speeds up to 3000 r.p.m. 1/4" shaft extends from both sides of motor. Measures 7 1/4" x 3 1/4" diam. overall. Shd. Wt. 6 3/4 lbs.

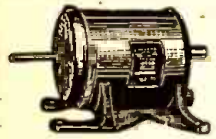

ITEM NO. 11 Your Price \$1.55

POWERFUL ALL-PURPOSE INDUCTION MOTOR

IDEAL FOR EXPERIMENTERS—101 USES

Sturdily constructed to precision standards, this self-starting shaded pole A.C. induction motor is powerful enough for a large variety of uses. Some of these are: Automatic Timing Devices, Current Interrupters, Electric Fans, Electric Chimes, Window Displays, Photo-cell Control Devices, Electric Vibrators, Small Grinders, Buffers and Polishers, Miniature Pumps, Mechanical Models, Sewing Machines, Phonograph Motors, Coffee Grinders, Motion Picture Projectors, Motorized Valves, Sirens, and other applications. Consumes about 15 watts of power and has a speed of 3,000 r.p.m. When geared down, this sturdy unit will constantly operate an 18-inch turntable loaded with 200 lbs. dead weight—THAT'S POWER!

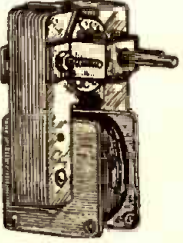

The motor is of midget dimensions, 3 inches high by 2 inches wide by 1 1/2 inches deep; has 4 convenient mounting studs; shaft is 3/8" long by 3/16" diameter, and runs in self-aligning, oil-retaining bearings; the best materials, perfect precision assembly and rigid inspection certify to its high quality, and assure long life. Designed for 110-20 volts, 50-60 cycles, A.C. only.

ITEM NO. 147 YOUR PRICE \$1.29

100 POWER TELESCOPE LENS KIT

Make your own high powered 6 ft. telescope! Now you can thrill to a closeup view of the worlds out in space. See the rings around Saturn, the mountains of the moon! Kit contains 3" diam., 75" focal length, ground and polished objective lens and 2 astronomical eye-pieces, magnification 50x and 100x. Complete kit with full instructions.

ITEM NO. 123 YOUR PRICE \$1.95

NEW-EXTRA LARGE LENS KIT—contains completely finished 4" diameter 100" focal length ground and polished objective lens, three 1 1/4" diameter eye-pieces giving 66x, 133x, and 200x, an aluminized diagonal for overhead viewing, and a color filter for insertion in any eyepiece.

ITEM NO. 123L YOUR PRICE \$3.95

HUDSON SPECIALTIES CO., 40 West Broadway, N. Y. C.

IT'S EASY TO ORDER—CLIP COUPON—MAIL NOW ORDER FROM THIS PAGE.

HUDSON SPECIALTIES CO., 40 West Broadway, Dept. RC-1041, New York, N. Y.

I have circled below the numbers of the items I'm ordering. My full remittance of \$..... (Include shipping charges) is enclosed.

OR my deposit of \$..... is enclosed (20% required), ship order C.O.D. for balance. No C.O.D. order for less than \$2.00. (New U. S. stamps, check or money order accepted.)

Circle Item No. wanted: 11, 33, 87, 123, 123L, 125, 147, 148

Name Address

City State

Send remittance by check, stamps or money order; register letter if you send cash or stamps.

AMAZING BLACK LIGHT!!

Powerful 250-Watt Ultra-Violet Bulb



The best and most practical source of ultra-violet light for general experimental and entertainment use. Makes all fluorescent substances brilliantly luminescent. No transformers of any kind needed. Fits any standard lamp socket. Made with special filter glass permitting only ultra-violet rays to come through. Brings out beautiful opalescent hues in various types of materials. Swell for amateur parties, plays, etc., to obtain unique lighting effects. Bulb only. Size of bulb.

Shp. Wt. 1 lb. ITEM NO. 87 YOUR PRICE \$2.00

WESTINGHOUSE WATTHOUR METER

Completely overhauled and ready for immediate service. Designed for regular 110-volt, 60 cycle 2-wire A.C. circuits. Service men use it in their shops to check current consumption of sets, soldering irons, etc. Keeps costs down. If dismantled, the parts alone would bring the price. The relay-actuated front train could be used as a counter on machines of various kinds. Simple to install: 2 wires from the line and 2 wires to the load. Sturdily constructed in heavy metal case. Size: 8 1/4" high, 6 1/4" wide, 5" deep, overall. Shp. wt. 14 lbs.

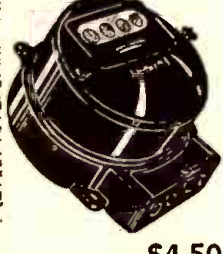

ITEM NO. 33 YOUR PRICE \$4.50

ELECTRIC HUMIDIFIER FOUNTAIN



Adds healthful moisture to the air in winter. Evaporates as much as a pint of water in 24 hours. Fountain is 14" in diam. Sprays 8 streams of water 5" above fountain head. Made of spun aluminum. Comes in five colors: Bronze, chrome, copper, red, green. No water connections required. Just plug into 110 volt, 60 cycle A.C. outlet. Current consumption few cents a month. Complete with base switch and 8 ft. power cord. Shipping wt. 9 lbs. List price \$14.95. Only a limited supply on hand.

ITEM NO. 125 YOUR PRICE \$4.95

1941 Catalog

A POSTAL CARD BRINGS IT TO YOU SEND FOR IT TODAY

- VACO PRODUCTS CO., 1603 S. Michigan Ave., Chicago, Ill.—C: D, E, M
- THE VALPEY CRYSTALS, Box 321, Holliston, Mass.—C: AR, D, E, G, M, SM, SS
- VASCO ELECTRICAL MFG. CO., 4116 Avalon Blvd., Los Angeles, Calif.—C: D, J, M
- THE VEGA COMPANY, 155 Columbus Ave., Boston, Mass.—C: A
- VERTI-FLEX ILLINOIS SEATING CORP., 2138 N. Racine Ave., Chicago, Ill.—C: AR, D, S, SS
- VERTROP MANUFACTURING CO., 132 Nassau St., New York, N. Y.—C: A
- JAMES VIBRAPOWR CO., INC., 341 N. Crawford Ave., Chicago, Ill.—C: A
- THE VIBROPLEX CO., INC., 832 Broadway, New York, N. Y.—C: A, D
- VICTOR ANIMATOGRAPH CORP., Davenport, Iowa—C: HO: A
- VIVI TONE COMPANY, 6321 Gratiot St., Detroit, Mich.—C: D
- VOGUE PRODUCTS CO., 8420 S. Ashland Ave., Chicago, Ill.—C: D, S
- THE VOLU-TONE COMPANY, 252 S. Broadway, Los Angeles, Calif.—C: D
- WARD LEONARD ELECTRIC CO., 31 S. St., Mt. Vernon, N. Y.—C: A
- WARD MANUFACTURING CO., 1813 Winona St., Chicago, Ill.—C: A
- WARD PRODUCTS CORP., 1523 E. 45th St., Cleveland, Ohio—C: D, M, S
- WARREN TELECHRON CO., Ashland, Mass.—C: HO: D, S
- WARWICK MANUFACTURING CORP., 1700 W. Washington Blvd., Chicago, Ill.—C: D, S
- EARL WEBBER COMPANY, 4350 W. Roosevelt Rd., Chicago, Ill.—C: A
- WEBER MACHINE CORP., 59 Ruffer St., Rochester, N. Y.—C: M, SS
- WEBSTER-CHICAGO CORPORATION, 5622 W. Bloomingdale Ave., Chicago, Ill.—C: AR, D, E, G, M, S, SS
- WEBSTER ELECTRIC CO., Racine, Wis.—C: A
- JOS. WEIDENHOFF, INC., 4344 W. Roosevelt Rd., Chicago, Ill.—C: D, E, M, S, SS
- WESTERN SOUND & ELECTRIC LABS., INC., 311 W. Kibbourn Ave., Milwaukee, Wis.—C: A
- WESTON ELECTRICAL INSTRUMENT CORP., Newark, N. J.—C: HO: A
- WHEELCO INSTRUMENTS CO., 1933 S. Halsted St., Chicago, Ill.—C: HO: A
- THE WIRE STRIPPER CO., P.O. Box 2421, E. Cleveland, Ohio—C: E, M
- WIRT COMPANY, 5221-27 Greene St., Phila., Pa.—C: AR, D, E, G, S, SS
- WINCHARGER CORPORATION, Sioux City, Iowa—C: A
- X-L RADIO LABORATORIES, 420 W. Chicago Ave., Chicago, Ill.—C: HO: A
- ZIERICK MANUFACTURING CORP., 385 Gerard Ave., New York, N. Y.—C: D, E, M, SS

14-Watt Amplifier

(Continued from page 229)

- One Mallory volume control, UC-513, 0.5-meg., R12;
- One Mallory volume control, K-12, 50,000 ohms, R10.

CONDENSERS

- Five Illinois Parts fid. 136, 5 mf., 50 V., C1, C5, C10, C16, C23;
- Seven Mallory, 8 mf., 450 V., CS-133, C4, C7, C11, C13, C19, C21, C22;
- Three National Union T-610, 0.1-mf., C2, C17, C20;
- Six National Union T-601, 0.01-mf., C3, C6, C9, C12, C14, C18;
- One National Union T-6002, 0.001-mf., C15;
- One National Union T-6005, 0.005-mf., C8.

MISCELLANEOUS

- One Thordarson T-17C00B choke, 15 hy., Ch.1, 150 ma.;
- One Stancor C-1707 choke, 2 hy., 50 ma., Ch.2;
- One Thordarson T-92R21 power transformer, P.T.;
- One Thordarson T-65594 output transformer, T1;
- One Toggle switch, Sw.;
- One Bud No. JL-1692S jewel light assembly;
- Six Crowe nameplates;
- Six Crowe knobs, No. 6308, red;
- Six Amphenol No. M1P8 receptacles;
- Four Amphenol No. M1P4 receptacles;
- Two mike input plugs, self-shorting type, J1, J2;
- Four Bud No. J-232 midget jacks, J3, J4;
- One Bud CB-666 chassis 8 1/2 x 15 x 3 ins. high;
- Two Bud No. ST glove-type shields;
- Two Bud No. T9 glove-type shields;
- Miscellaneous hardware, wire, solder, etc.

TECHNICAL REVIEW OF CATALOGS, ETC.

Meissner 1941 General Catalog.—Includes diagrams of various available kits ranging from battery electrical portables through various types of receivers and tuners to experimental equipment and communications receivers. (Meissner Mfg. Co., Mt. Carmel, Ill.)

Mallory 1941 Catalog.—This catalog of carbon and wirewound controls of all types, switches, jacks, resistors, condensers, vibrator power packs and dry-disc rectifiers, contains useful information on the selection of various types of these instruments. (P. R. Mallory & Co., Inc., Indianapolis, Ind.)

Bud Radio General Catalog No. 241.—In addition to cataloging the extensive Bud line, this publication contains a set of tables useful in radio work. (Bud Radio, Inc., Cleveland, Ohio.)

United Transformer Corp. Catalog "Industrial Components."—Contains diagrams, illustrations and descriptions of Varitran current- and voltage-controlled devices. (United Transformer Corp., New York, N. Y.)

Mallory 1941 Replacement Vibrator Guide.—This Guide includes a replacement vibrator chart listing the requirements for practically all car-radio receivers. Part of the publication is devoted to a cross-reference. Vibrator basing diagrams are given. Also included is the technical article "Installing Radios in 1941 Cars". (P. R. Mallory & Co., Inc., Indianapolis, Ind.)

Speed Up Your Production with Warner "Fotoelectric" Products.—This folder pictorially shows the applications of Warner's light sensitive equipment. (Warner Products Corp., Chicago, Ill.)

Presto Recording Corp., "How to Make Talking Pictures at Home". Available for 25c. This publication is "A Complete Description of the Presto Syncro-Sound Recorder and Its Operation." It is a really useful booklet for anyone wishing to add disc-sound to home or industrial talkies. (Presto Recording Corp., New York.)

Replacement Guide General Batteries for Portable Battery Receivers.—This publication lists the battery complements of practically every battery and battery-electric portable. (General Dry Batteries, Inc., Cleveland, Ohio.)

Amplical—Industrial and Office Communication DeLuxe. Webster—Chicago.—This publication includes block diagrams and descriptions of various applications of intercommunicators, and concludes with a description of a high-power paging system. (The Webster Company, Chicago, Ill.)

Radiart Vibrators—"The Guaranteed Exact Duplicate".—Under this title Radiart Corp. has issued form 541 containing the following sections: A, Vibrator Replacement List (replacements for practically every make of radio receiver utilizing vibrator power supplies); B, Cross-Index by Base Diagram; C, Buffer Circuits; D, Container Shapes; E, Radiart Vibrator Specifications; F, Cross-Index, Radiart Numbers and Numbers of Other Vibrator and Radio Set Manufacturers; G, Cross-Index, Radiart and Original Equipment Part Numbers; H, Cross-Index by Vibrator Types. (The Radiart Corp., Cleveland, Ohio.)

Sprague Fluorescent Lamp Bulletin.—This form C350 of Sprague Products Co. contains circuits and description of the application of Sprague condensers in fluorescent lighting and suppression of radio interference. (Sprague Products Company, North Adams, Mass.)

Burgess Replacement Guide, Revised Edition, June 1941.—An extensive Guide which lists battery replacements for practically every radio receiver on the market utilizing battery power. A useful tabulation is the listing of dimensions of the various types of Burgess batteries. Of even greater interest is the listing of comparative stock numbers of Burgess batteries compared with 11 other makes. Still another interesting item, a battery replacement guide, supplies

data on many battery-operated instruments, special-purpose batteries are also described. Concluding the publication are charts giving the service ratings of various "A" cells and "B" batteries. (Burgess Battery Company, Freeport, Ill.)

Complete Transformer Catalog No. 400-F 1941—Fall-Winter—1942.—In addition to listing the products of Thordarson Electrical Mfg. Co., this catalog contains tables on how to choose various types of transformers. To meet various requirements of tube arrangements, etc., equivalent requirements in connection with chokes are given. (Thordarson Electric Mfg. Co., Chicago, Ill.)

"A Transmitter Frequency Control Unit with Three-Band Output".—This reprint from June, 1941, QST describes the self-contained, cabinet-type exciter or low-power transmitter designed by G. W. Shuart. Its schematic circuit is given. (The Hammarlund Manufacturing Co., Inc., New York, N. Y.)

Complete Transformer Catalog—Stancor.—Here is a listing of Standard Transformer Corp. products, which in addition to presenting component characteristics in convenient tabular form, also supplies useful information on types of transformers for use with various tube combinations. (Standard Transformer Corp., Chicago, Ill.)

UTC Transformer Components.—Carrying only this identification, United Transformer Corp. has released a wall-card 8½ x 11 ins., presenting on one side a table of decibels vs. voltage and power, and on the other, charts of the straight-edge type whereby unknown values may be obtained by computing against knowns for the characteristics: Inductance, Reactance, Capacity or Frequency. (United Transformer Corp., New York.)

"An All-Purpose Mike for P.A.?".—This reprint from a recent issue of Radio Today is available from Amperite Corp. and describes the Universal application of an Amperite velocity microphone. Interesting field patterns are given. (Amperite Corp., New York, N. Y.)

Ham Tips from RCA, March-April 1941.—This edition of a periodical issued by RCA Mfg. Co., Inc., includes a circuit diagram and engineering data in description of the application of the RCA type 829 beam power tube which outputs approximately 83 watts at 200 mc. A suitable power supply is also diagrammed. (RCA Manufacturing Co., Inc., Camden, N. J.)

Light Marches On with Hygrade Fluorescent.—This brief summary of facts concerning fluorescent lighting includes circuits, tables, listing essential tube data and technical description of the fluorescent factors entering into the operation of fluorescent lights. Form F-164. (Hygrade Sylvania Corp., Salem, Mass.)

Hallcrafters Communications Equipment.—Under this title The Hallcrafters, Inc., has prepared a brochure containing technical descriptions of Hallcrafters' communications equipment including a circuit breakdown of the crystal filter circuit incorporated in Super-Skyrider SX-28 together with curves of selectivity of A.V.C. action. (The Hallcrafters, Inc., Chicago, Ill.)

Solar A.C. Motor Starting Capacitors for Replacement Purposes and Cap-Check A.C. Capacity Checker.—This bulletin A.C. contains complete listing by manufacturer and part number, "to size" replacements for 90% of motor starting condensers (capacitors) now in general use. (Solar Manufacturing Corp., Bayonne, N. J.)

Essential Equipment Required for Complete Radio Service.—This single sheet issued by Supreme Instruments Corp. contains on one side a block illustration showing how various types of equipment are utilized in making various radio receiver tests; and on the other, description of this chart together with other information under the title "How to Analyze Your Own Shop". (Supreme Instruments Corp., Greenwood, Miss.)

GEOPHYSICAL PROSPECTING PRINTS (TREASURE FINDERS)



50c EACH

BLUE PRINTS and INSTRUCTIONS

For Building the Following Treasure Finders and Prospecting Outfits

- Folder No. 1. The "Radio-Offshore Pilot"—consists of a 2-tube transmitter and 3-tube receiver. Principle: radiated Wave from transmitter loop is reflected back to receiver loop. Emits visual and aural signals.
- Folder No. 2. The "Harmonic Frequency Locator"—Transmitter radiates low frequency wave to receiver, tuned to one of Harmonics of transmitter. Using regenerative circuit. Emits aural signals.
- Folder No. 3. The "Beat-Note Indicator"—Two oscillators so adjusted as to produce beatnote. Emits visual and aural signals.
- Folder No. 4. The "Radio-Balance Surveyor"—a modulated transmitter and very sensitive loop receiver. Principle: Balanced loop. Emits visual and aural signals. By triangulation depth of objects in ground can be established.
- Folder No. 5. The "Variable Inductance Monitor"—a single tube oscillator generating fixed modulated signals and receiver employing two stages R.F. amplification. Works on the inductance principle. Emits aural signals.
- Folder No. 6. The "Hughes Inductance-Balance Explorer"—a single tube Hartley oscillator transmitter and sensitive 3-tube receiver. Principle: Wheatstone bridge. Emits aural signals.
- Folder No. 7. The "Radiodyne Prospector"—a completely shielded instrument. Principle: Balanced loop. Transmitter, receiver and batteries enclosed in steel box. Very large field of radiation and depth of penetration. Emits aural signals.

With any one of the modern geophysical methods described in the Blue-Print patterns, radio outfits and instruments can be constructed to locate metal and ore deposits (prospecting); finding lost or buried treasures; metal war relics; sea and land mines and "duds"; mineral deposits; subterranean water veins; oil deposits (under certain circumstances); buried gas and water pipes; tools or other metallic objects sunken in water, etc., etc.

Each set of blueprints and instructions enclosed in heavy envelope (9½" x 12½"). Blueprints 22" x 34"; eight-page illustrated 8½" x 11" folder of instructions and construction data. **50c** Add 5c for postage

The complete set of seven folders **\$3.00**
Shipping weight 2 lbs. (add 25c for shipping anywhere in U.S.A.)

TECHNIFAX

1917 S. STATE ST. RC-1041 CHICAGO, ILL.

TECHNIFAX 1917 So. State, Chicago, Ill.

Enclosed herewith \$..... for which mail to address below:

Treasure Finder No. 1, 2, 3, 4, 5, 6, 7.
Complete set of seven folders.

NAME

ADDRESS

CITY STATE
RC-1041

Index to advertisers

PUBLISHERS

Audel, Publishers.....199
 Book Give-Away Plan.....244
 Data Print Co.....232
 National Plans Inst.....243
 Radcraft Publications, Inc.
 208, 224, 225, 228, 232, 247
 Reference Annual.....200
 Radio & Technical Pub. Co.....227
 Radiolab Publishing Co.....217
 Supreme Publications.....214, 232
 Technifax.....249, 255

RADIO PARTS

Aerovox Corporation.....227
 Amperite Co.....241
 International Resistance Co.....207
 Meissner Mfg. Company.....210
 Ohmite Mfg. Company.....248
 Solar Mfg. Corp.....249
 Sprague Products Co.....209

RADIO SETS

Goldentone.....221
 Hallcrafters Co.....Back Cover
 Midwest Radio Corporation.....217
 Radio Shack, The.....Inside Front Cover

RADIO SUPPLY HOUSES

Allied Radio Corp.....211
 Burstein-Applebee Co.....215
 Hudson Specialties Co.....254
 Radolek Co.....217

SCHOOLS

Capitol Radio Eng. Inst.....197
 Commercial Radio Institute.....195
 Coyne Radio School.....195
 Lincoln Engineering School.....197
 National Radio Institute.....193
 National Schools.....199
 New York Y.M.C.A. Schools.....199
 Port Arthur College.....197
 Radio Training Assoc.....199
 RCA Institutes.....199
 Sprayberry Academy of Radio.....195

SOUND & RECORDING EQUIPMENT

Amplifier Co. of America.....241, 243
 Jensen Radio Mfg. Co.....223
 John Meck Industries.....241
 Universal Microphone Co., Ltd.....241
 University Laboratories.....241

TEST EQUIPMENT

National Union Radio Corp.
 Inside Back Cover
 Radio City Products Co.....215
 Readrite Meter Works.....214
 Walter L. Schott Co.....221
 Supreme Instruments Corp.....221
 Triplett Electrical Instruments Co.....210
 Weston Elec. Instrument Corp.....209

TUBES

Hygrade Sylvania Corp.....219

MISCELLANEOUS

Classified Section.....256
 Flight Magazine.....249
 Lancaster, Allwine & Rommel.....210
 Lemurian Fellowship.....210
 Remington Rand, Inc.....251

(While every precaution is taken to insure accuracy, we cannot guarantee against the possibility of an occasional change or omission in the preparation of this index.)

BOOK REVIEW

(Continued from page 199)

HANDBOOK OF BROADCASTING, 2nd Edition, by Waldo Ahbot (1941). Published by McGraw-Hill Book Company, Inc. Size 6 1/4 x 9 1/4 ins., cloth covers, 231 pages. Price \$3.50.

The Assoc. Professor of Speech and Director of Broadcasting, University of Michigan, and Educational Directory of Station WJR as well, has incorporated changes of importance in this revised 2nd Edition of his "Handbook," suggested by instructors in 50 universities where the original version has been used as a text; and, by students who have gone into various broadcast stations.

The book presents instruction material in all phases of broadcasting (except the engineering) of the planning, writing, production and purpose of radio programs; and of commercial, educational, vocational and other aspects of radio broadcasting.

The book is recommended not only as a guide book of students and teachers of speech and broadcasting, and for teachers receiving educational programs in the class-rooms but also for those in the radio profession, for the radio listener and for those who are or hope to be radio specialists or writers.

Note also that many of the principles given in this book are almost equally applicable to Public Address specialists and those who have occasion to talk over a P.A. system. In fact, Chapter 20 is entitled "Public-Address and Sound-Recording Equipment in the School" and discusses not only the equipment but also sound microphone technique.

The following selected, abbreviated chapter headings reveal the scope and nature of the entire contents as follows: Technical Fundamentals of Radio; Radio Speaking; Pronunciation; Articulation, Intonation, Rhythm; News, Sports, Poetry and Children's Programs; Impromptu and Extempore Speech Programs; Writing and Directing Radio Plays and Serials; Sound Effects; Writing Commercial Continuity; Broadcasts to Schools; Public-Address and Sound-Recording Equipment in the School; Electrical Transcriptions; The Law as It Affects Broadcasting; Radio as a Vocation; Glossary; Appendix; Specimen Scripts; Bibliography; Suggested Class Assignments; General References; Index.

(Ordinarily this reviewer would not present such a lengthy listing of the contents of a book, but in the case of the "Handbook of Broadcasting," it was felt to be essential in order to properly outline the extensive coverage of this excellent reference work.)

RADIO ENGINEER'S POCKET BOOK, by F. J. Camm, 2nd Edition (1941). Published by Chemical Publishing Co., Inc. Cloth covers, size 4 1/2 x 6 3/4 ins., 147 pages. Price \$1.50.

Electrical engineers, chemical engineers, and others in the engineering profession long have had reference books making available to them in handy form such elementary reference material as formulas, tables, definitions, etc.

Radiomen are now offered a second*, approximate equivalent in the form of a 147-page pocket book by F. J. Camm. This book meets the elementary needs of those in various branches of radio: Servicemen, students, designers, operators, manufacturers, transmitter specialists, etc. Arithmetic, geometric, and trigonometric formulas as well as measuring formulas have been included.

*Last month Radio-Craft reviewed Keith Henney's exceptionally comprehensive, desk-size "Radio Engineer's Handbook" (945 pgs.)

NATIONAL POLICY FOR RADIO BROADCASTING, by C. B. Rose, Jr. (1940). Published by Harper & Brothers, Size 5 3/4 x 8 3/4 ins., cloth covers, 289 pages. Price \$3.

The National Economic and Social Planning Association has for its single purpose the investigation of significant national problems with a view to aiding in the shaping of new policies. "National Policy for Radio Broadcasting" is an analysis, of radio broadcasting in the United States, which was made to further the purpose of N.E.S.P.A. The Parts headings below indicate the general nature of the treatment of the subject matter.

Part II consists of 3 chapters. Their titles carry this analysis further, to wit: Chapter 1, "Limitations on the Number of Stations"; Chapter 2, "Problems of the Location of Stations"; Chapter 3, "Problems of 'Superpower'".

There are 18 tables in this book, otherwise it is unillustrated. The main aspects of the problems of putting programs on the air are described, including discussion of the commercial structure, program content, freedom of the air, and related topics. The analysis dates from the advent of commercial broadcasting in 1920. It is a searching analysis of what makes broadcasting tick and what can be done to continue the progress of this art.

BBC HANDBOOK, Published by Jarrold & Sons, Ltd., Norwich & London. Size 5 x 7 1/2 ins., cloth covers, 128 pages. Price 50c.

War or no war, the British Broadcasting Corporation continues to publish this annual résumé of radio activities in the British Empire. Through the pages of this book is shown the progress of British radio during the last 12 months on record. Such chapter headings as "From Peace to War," "Au Revoir, Television," "A War Diary," suggest the poignant nature of the BBC Annual of 1940. Concluding the book are a number of chapters in a 20-page reference section. Virtually a year-book, it holds considerable interest for American listeners who may have facilities for reception of British stations direct on their short-wave channels.

PLASTICS IN INDUSTRY, by "Plastes" (1940). Published by Chemical Publishing Co., Inc. Size 5 1/2 x 8 3/4 ins., cloth cover, 241 pages. Price \$5.

The tremendous impetus which unsettled war conditions have given plastics, and especially its increasing use as a satisfactory substitute for metals essential in the Defense program, make "Plastics in Industry" an exceptionally timely reference work of interest to many technicians in the various fields of the radio industry.

Radio engineers who wish to know to what extent the electrical or mechanical properties of various plastics may be used in new equipment will find their questions answered in this book. Experimenters and laboratory workers who wish to know to what extent they can use plastics in their work will want to study the tables, formulas, etc., which are here presented in accurate form. "Plastics in Industry" is a technical introduction to this new industry.

OPPORTUNITY AD-LETS

Advertisements in this section cost 15 cents a word for each insertion. Name, address and initials must be included at the above rate. Cash should accompany all classified advertisements unless placed by an accredited advertising agency. No advertisement for less than ten words accepted. Ten percent discount six issues, twenty percent for twelve issues. Objectionable or misleading advertisements not accepted. Advertisements for November 1941 issue must reach us not later than September 11th.
 Radio-Craft • 20 Vesey St. • New York, N. Y.

AGENTS WANTED

NUSILVER PLATING LIQUID. APPLY WITH CLOTH. Cleans, silverplates and polishes at one time. \$1.00 postpaid. NuSilver, Dept. 114, Aurora, Ill.

BOOKS AND MAGAZINES

ASSURE YOURSELF OF GREATER PROFITS BY doing radio service jobs more quickly. Authentic service guides show you the way to locate and correct troubles in any radio receiver. Gerneback Official Radio Service Manuals show you how to complete more repair jobs in less time—how to earn more money by faster servicing. Radcraft Publications, 20 Vesey St., New York City.

WHAT DO YOU KNOW ABOUT AMPLIFIERS AND Sound Systems? The Amplifier Handbook and Public Address Guide covers P.A. from A to Z. Most complete and authentic book published on the subject. Contains 80 pages of vital information on Amplifiers, P.A. Systems, Speakers, Accessories, Pickups, Microphones, etc. Printed on fine coated stock, with numerous photographic illustrations and explanatory diagrams, and only 25c. See page 228.

EDUCATIONAL COURSES

CORRESPONDENCE COURSES AND EDUCATIONAL books, slightly used. Sold, Rented, Exchanged. All subjects. Satisfaction guaranteed. Cash paid for used courses. Complete details and bargain catalog FREE. Write Nelson Company, 500 Sherman, Dept. K-242, Chicago.

FLUORESCENT LIGHTING

24" FLUORESCENT BENCH LIGHT \$1.49. LESS TUBE. Harold Davis, Jackson, Mississippi.

WANTED—TO BUY

WANTED: HIPI AM-FM EQUIPMENT. PRIVATE. Cash. Box 81, Radio-Craft.

WHERE YOU FIND NATIONAL UNION

YOU FIND *Better* RADIO SERVICE



Used N. U. equipment plan when I first started in business 9 years ago and if it hadn't been for N. U. I would never have gotten the equipment up to date.

*Bay Shore Radio & Appliance Bay Shore, N. Y.
(William Exeter, Jr., Prop.)*

The Success of Better Equipped Radio Shops speaks for itself. Here is a profitable radio service business built up in the shadow of one of the nation's most competitive markets, Metropolitan New York.

NATIONAL UNION invites all radio service dealers to enjoy the benefits of the **N. U. SHOP EQUIPMENT PLAN**. The latest in tube testers and test equipment are available to you, immediate delivery. More than 50,000 completed deals prove the success of this plan. Investigate Now.

ADDITIONAL PRODUCTS . . .

PANEL LAMPS
EXCITER LAMPS
PHOTO ELECTRIC CELLS
DRY BATTERIES

CATHODE RAY TUBES
SOUND EQUIPMENT
SOUND ACCESSORIES
FLASH LIGHT BULBS

Ask Your N.U. Distributor or Write

NATIONAL UNION RADIO Corp.

57 STATE STREET
NEWARK, N. J.



Radio Tubes

. . . More Radio Service Dealers use National Union than any other make . . . there must be a good reason why.



Condensers

Complete line . . . Same Super Quality as found in N. U. Tubes. Just try them.



Sound Extra Tubes

. . . a line of heavy duty radio tubes for sound work . . . an exclusive N. U. development.



Batteries

. . . The only line of Dry Batteries sold exclusively to the radio Trade . . . You can make more money.



ONCE again Hallicrafters lead the amateur communications field with quality and performance in one of the greatest values ever offered. The New 1941 15-Tube Super Sky-rider, "the best selling quality communications receiver," gives you all the features, even the ones usually found on higher priced receivers, including electrical band spread over entire range of the receiver.

Check these points: Rigid girder construction chassis, 15 tubes — 6 Bands—Frequency range 550 kc. to 43 mc.—Large, calibrated main dial—Band-spread dial calibrated for the

10, 20, 40, 80 meter amateur bands also on the International short wave Broadcast Channels—Tone Control—Send-Receive Switch—ANL Switch—RF Gain Switch—AVC-BFO Switch—2 stages preselection — Improved adjustable noise limiter—Beat Frequency Oscillator — antenna trimmer — AF Gain switch—6 position selectivity control—Bass boost switch—Wide Angle "S" meter — Band pass audio filter — Phone jack! Cabinet dimensions: 20½" x 14½" x 9½" — Complete with crystal and tubes. (Hallicrafters - Jensen Bass Reflex Speakers Available.)

THE BEST SELLING

Quality

RECEIVER

the hallicrafters inc.

CHICAGO, U. S. A.

USED BY 33 GOVERNMENTS
SOLD IN 89 COUNTRIES